

مسالكو  
ثقتك بمكانها

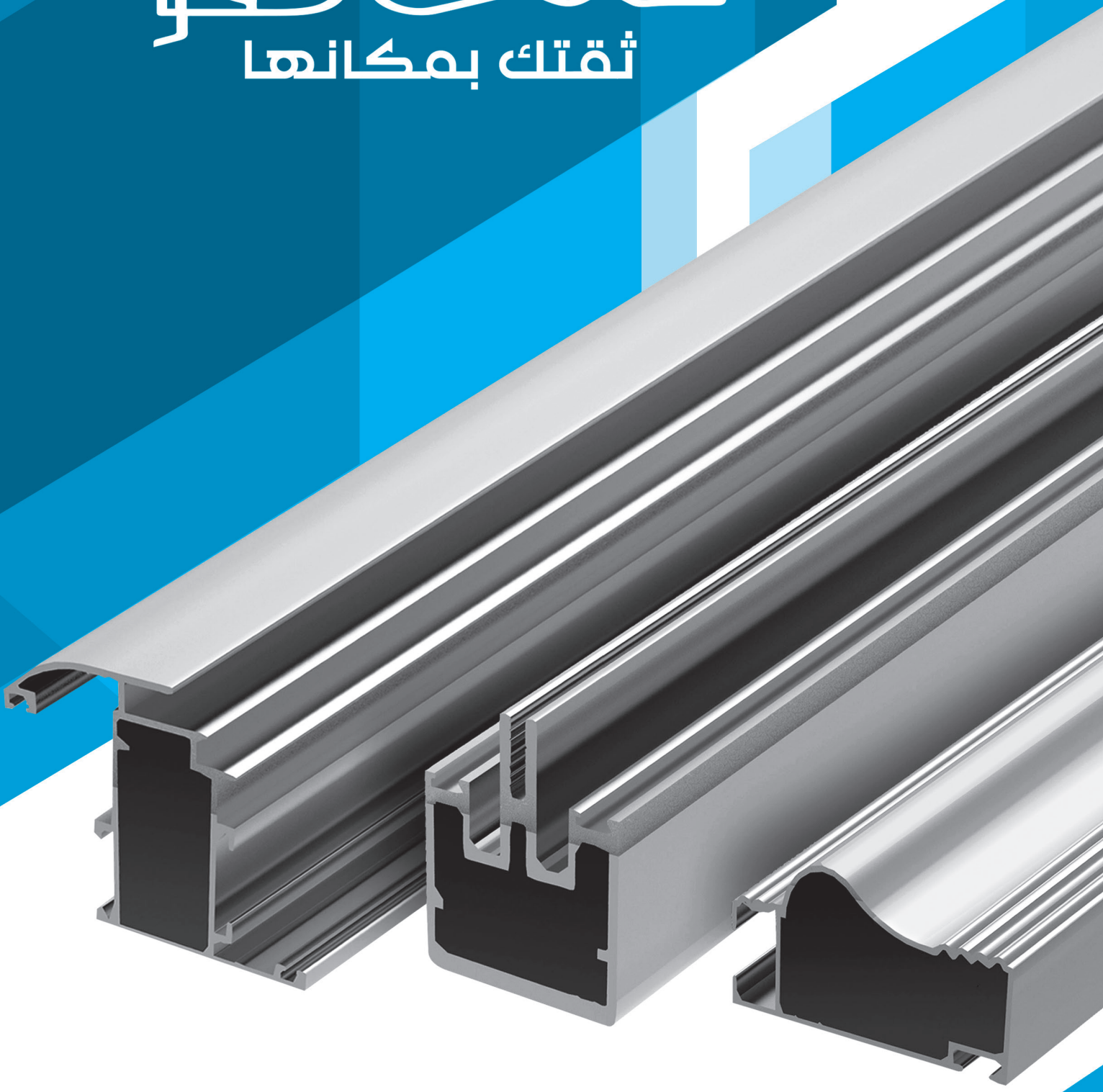

مقاطع الألمنيوم بجميع الأنظمة

مسالك  
ثقتك بمكانها

# مسالكو

## شركة مسوح للألمنيوم

أسسها المهندس سعد الله مسوح عام 1969, و تعتبر شركة مسالكو إحدى أقدم الشركات المتخصصة في إنتاج و تلوين مقاطع الألمنيوم في سوريا. ابتدأت شركة مسالكو مسيرتها بأعمال تداول وتركيب مقاطع الألمنيوم كالنوافذ و الأبواب و خزائن المطبخ وغيرها, و بعد 34 عاما من النجاح في مجالي التداول و التركيب بدأت الشركة بسحب و إنتاج مقاطع الألمنيوم في عام 2003.

تعد مسالكو شركة رائدة في أعمال الألمنيوم في سوريا و تأمل أن تصبح الخيار الأول في المنطقة. تفخر مسالكو باستخدامها أحدث التقنيات و آليات التشغيل لإنتاج مقاطع ألمنيوم بجودة عالية و بأسعار منافسة. كما تفخر مسالكو أيضاً بقدرتها على التسليم السريع و تحقيق تجانس في جودة و ألوان أصنافها إضافة لتقديمها طيفاً متنوعاً من المنتجات. هذا و تعمل شركة مسالكو أيضاً ضمن معايير الجودة و التسامحات التي تتفق مع معايير الجودة الأوروبية, حيث يمكنكم العثور على جدول التسامحات و معايير الجودة في نهاية هذا الكانالوج.

حالياً تقوم مسالكو بتشغيل خطي سحب ألمنيوم, حيث تصل الاستطاعة الإنتاجية بتشغيلهما معاً إلى سحب 15,000 طن من مقاطع الألمنيوم سنوياً. تقوم مسالكو أيضاً بتشغيل خطي تلوين أكسدة (أنودايز ) و خطي تلبيس ألوان الخشب و خط لطلاء البودرة و خط لإنتاج شفرات الأبجور و مصهر إعادة تدوير للألمنيوم.

تقدم مسالكو العديد من ألوان الأكسدة و الخشبي و البودرة. بالإضافة إلى هذا الكانالوج يمكننا أن نقدم لكم عينات من الألمنيوم لعرض مجموعة الألوان التي ننتجها حالياً. كما أننا نمتلك القدرة على إنتاج أي لون بحسب رغبة الزبون. نأمل أن يلبي هذا الدليل المتطلبات التي تبحثون عنها, و نود التنويه إلى أن جميع أوزان المقاطع المعروضة هي أوزان تقديرية و يمكننا توفير أوزان مختلفة لكل المقطع. إذا كنتم لا تجدون ما تبحثون عنه فنحن قادرون على توفير قوالب خاصة تلي حاجاتكم من المقاطع المطلوبة.

رضا الزبائن من أولوياتنا ونحن نكفل كافة منتجاتنا بشكل كامل. نشكر لكم اهتمامكم بمسالكو و في حال وجود أية استفسارات يمكنكم الاتصال بنا تبعاً للمعلومات الموجودة على الغلاف الخلفي لهذا الكانالوج.

# MASALCO

Massouh Aluminium Company

Founded by Saadallah Massouh in 1969, Masalco is one of the oldest companies specialized in aluminium profiles in Syria. Initially, Masalco began by trading and installing aluminium profiles as windows, doors, kitchen cabinets, and other items. Following 34 years of success in trading and installing, the firm began manufacturing aluminium profiles in 2003.

Already considered the leading aluminium company in Syria, Masalco hopes to become the number one choice in the region. Masalco prides itself on utilizing the latest technologies and processes which allow us to produce high quality aluminium profiles at competitive prices. Masalco also takes pride in having a fast delivery time, achieving product color and quality consistency, and offering a wide variety of products. Masalco's tolerances on dimensions and form conforms to European standards and can be found at the end of this catalogue.

Masalco currently operates two extrusion presses, together having the capacity to extrude more than 15,000 tons of aluminium profiles per year. It also operates two anodizing lines, two wood-finish lines, one powder coating line, one rolling shutter line, and one aluminium recycling plant.

Masalco offers many anodizing, powder coating, and wood finish colors. In addition to this catalogue, we can provide you with aluminium samples to show the range of colors that we currently produce. We also have the ability to produce any color as per customer request. We hope that you will find what you are looking for in this catalogue. Please note that all section weights shown are estimates and that we are able to provide different weights for each section. If you do not find what you are looking for, we are able to provide custom dies in order to provide any sections you may require.

Customer satisfaction is our priority and we fully guarantee all of our products. We thank you for your interest in Masalco. If you have any questions, you may find our contact information on the back cover of this catalogue.

The Masalco Team

الصفحة	نوع المقطع
107-94	مقاطع لبنان
111-108	مقاطع مابكو
113-112	سحاب خاص
117-114	بكدوش
120-118	ثوابت بللور
122-121	مقاطع العراق
124-123	مقاطع ليبيا
131-125	متنوعة
138-132	زوايا وتيوبوات وبواري
140-139	بارات
148-141	مقاطع الإمارات العربية
174-149	معايير الجودة
185-175	فهرس المقاطع

الصفحة	نوع المقطع
22-6	سحاب عريض
37-23	سحاب ضيق ومعدل
44-38	كوادر
48-45	زد عريض وضيق
50-49	تية وبركلوز ومفصلات
54-51	أبجورات
64-55	ديكور ومطابخ
67-65	درايزين
68	قواطع
75-69	تكييف وتبريد
81-76	ستائر زجاجية
88-82	ستائر وإنارة
89-93	كارتن وول

# INDEX

Section Type	Page
Sliding 95-120 mm	6-22
Sliding 75-98 mm	23-37
Hinged Frames	38-44
Hinged Shutters	45-48
T-Sections + Hinges	49-50
Shutter Sections	51-54
Decorative & Kitchen Sections	55-64
Handrail Sections	65-67
Partition Sections	68
Air Conditioning	69-75
Curtain Glass	76-81
Curtain and Lighting	82-88
Curatin Wall	89-93

Section Type	Page
Lebanon Sections	94-107
Mabco Sections	108-111
Private Sections	112-113
Shower Sections	114-117
U channels	118-120
Iraq Sections	121-122
Libya Sections	123-124
Miscellaneous	125-131
Angels + Tubes + Pipes	132-138
Anodized Bars	139-140
UAE Sections	141-148
Quality Standards	149-174
Reverse Index	175-185

سالكو

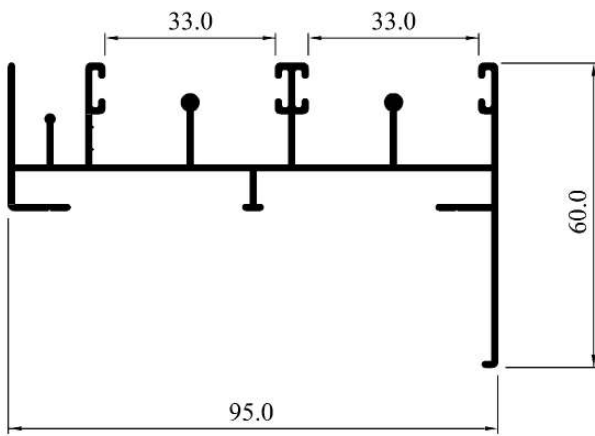

**10005**

Est Weight: 1.040 kg/m

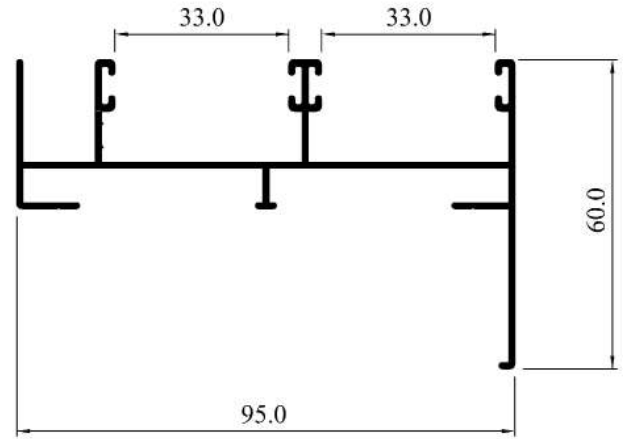

**10006**

Est Weight: 0.858 kg/m

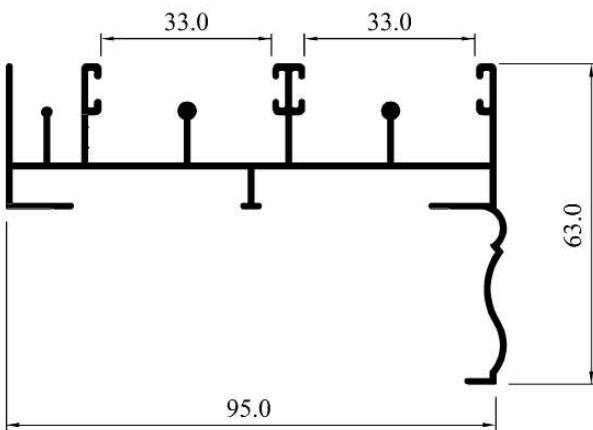

**10009**

Est Weight: 1.040 kg/m

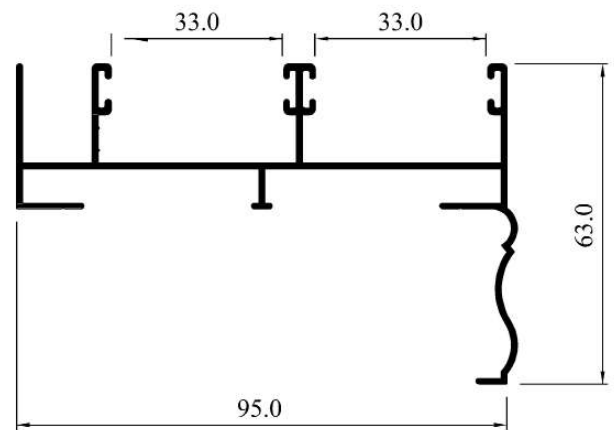

**10010**

Est Weight: 0.858 kg/m

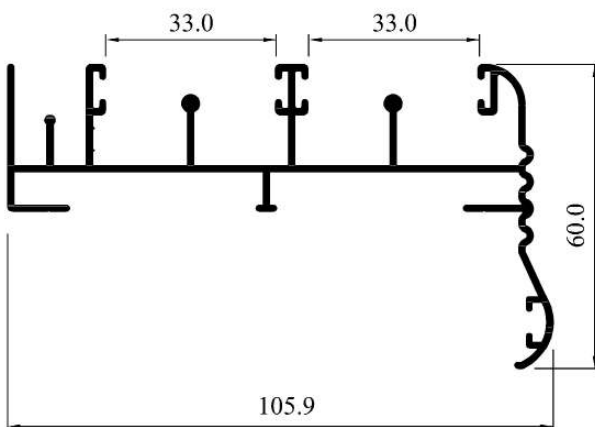

**10013**

Est Weight: 1.200 kg/m

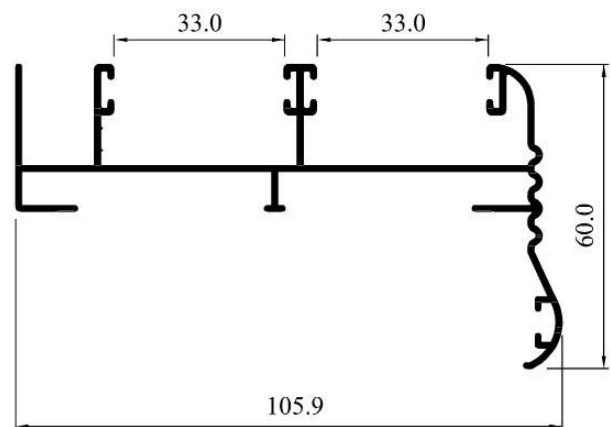

**10014**

Est Weight: 0.893 kg/m

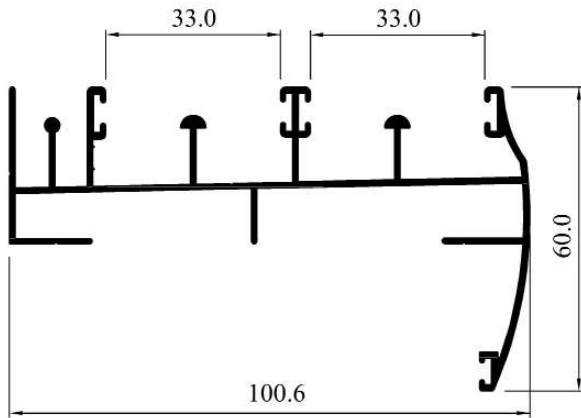

**10063**

**Est Weight: 1.072 kg/m**

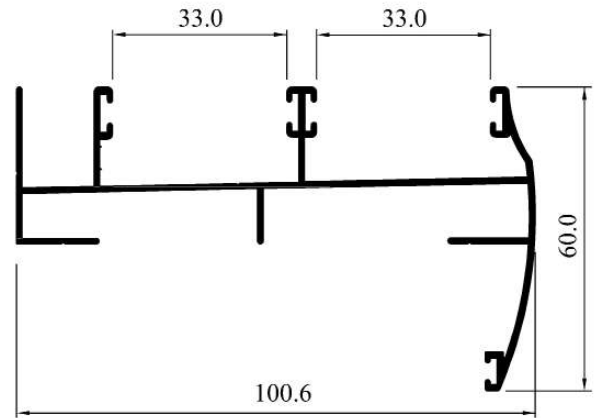

**10064**

**Est Weight: 0.883 kg/m**

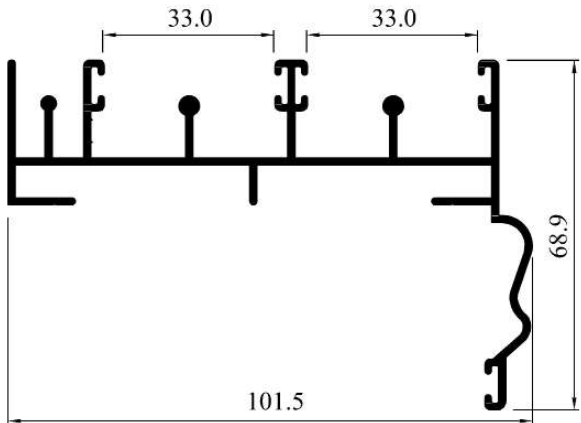

**10084**

**Est Weight: 1.440 kg/m**

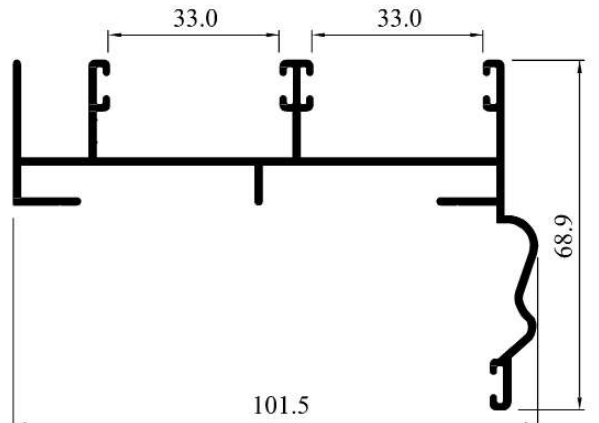

**10083**

**Est Weight: 1.133 kg/m**

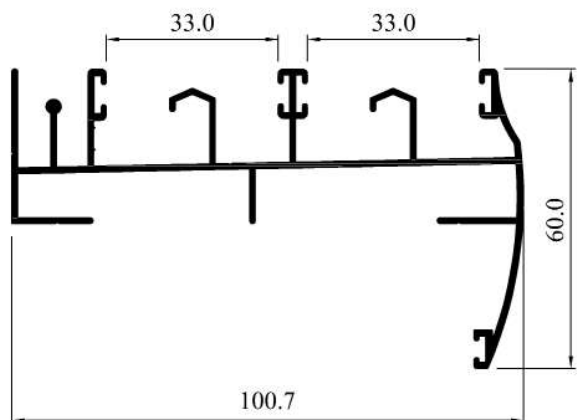

**10120**

**Est Weight: 1.192 kg/m**

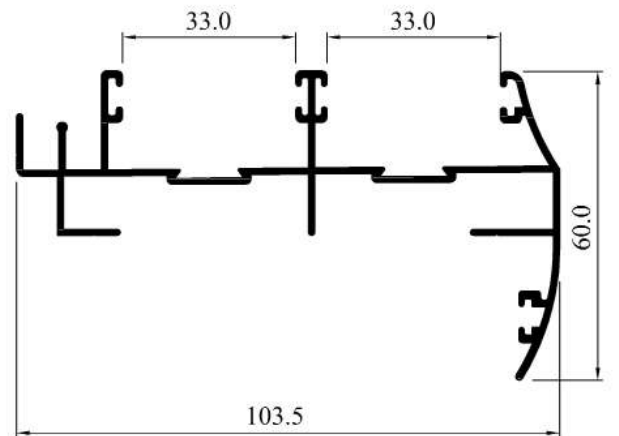

**10102**

**Est Weight: 1.096 kg/m**



سلكو

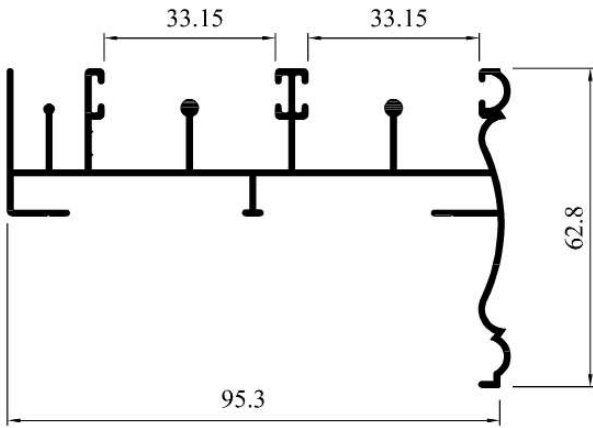

**10129**

**Est Weight: 1.040 kg/m**

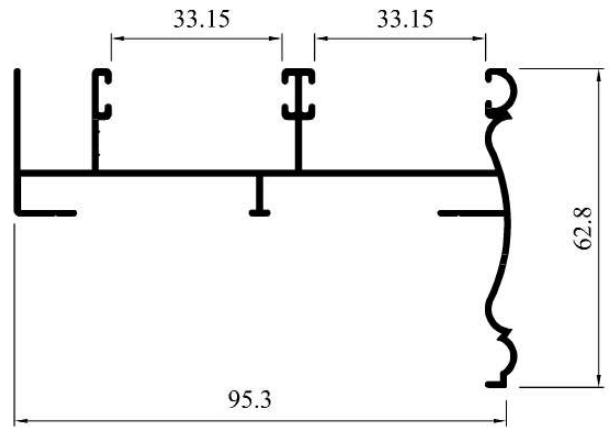

**10128**

**Est Weight: 0.858 kg/m**

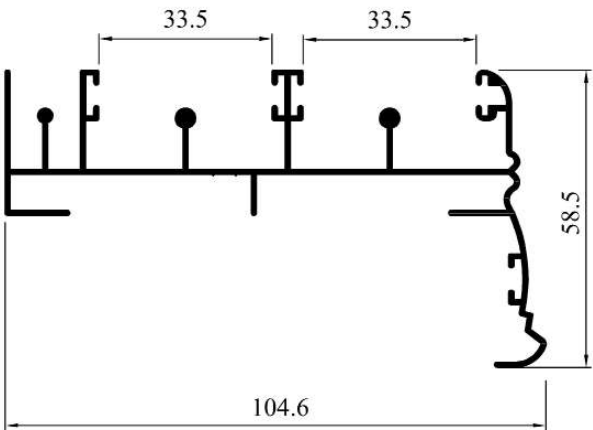

**10160**

**Est Weight: 1.040 kg/m**

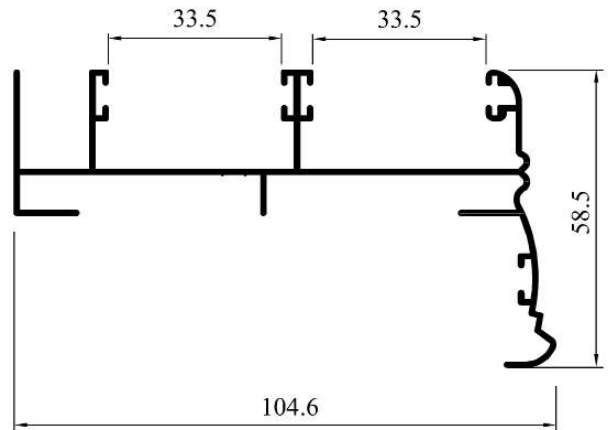

**10161**

**Est Weight: 0.858 kg/m**

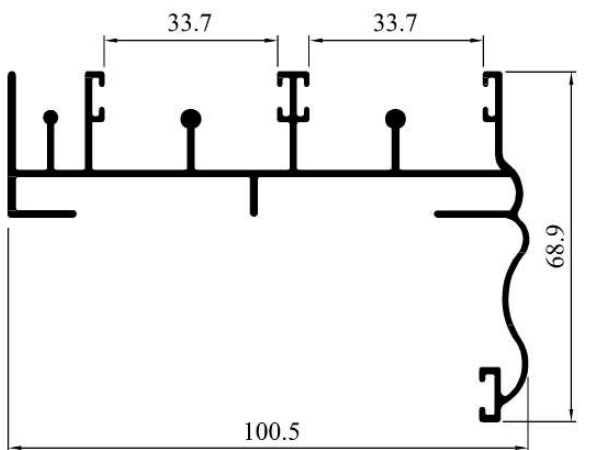

**10191**

**Est Weight: 1.173 kg/m**

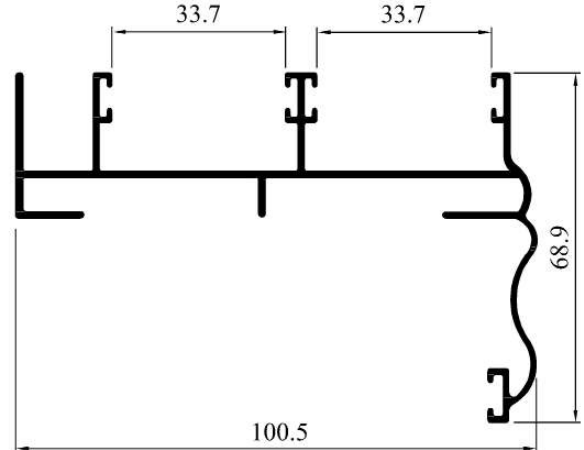

**10192**

**Est Weight: 1.008 kg/m**

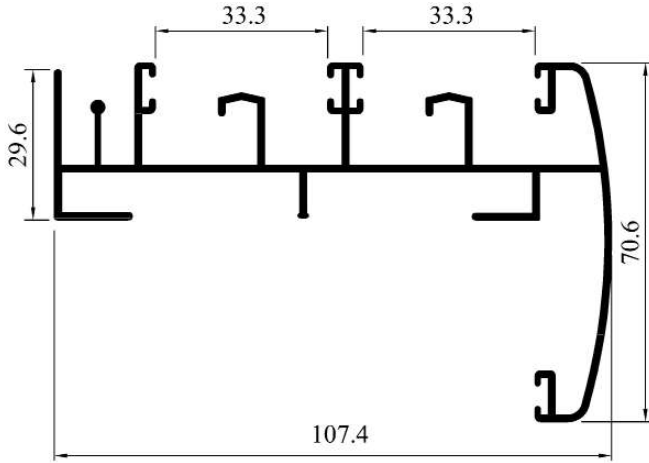

**10217**

**Est Weight: 1.392 kg/m**

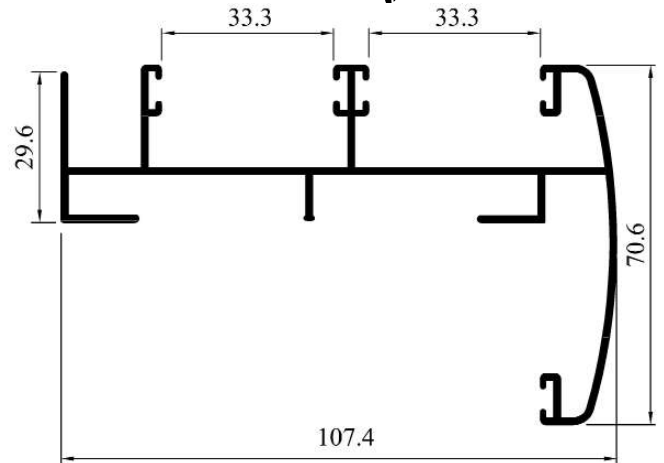

**10218**

**Est Weight: 1.194 kg/m**

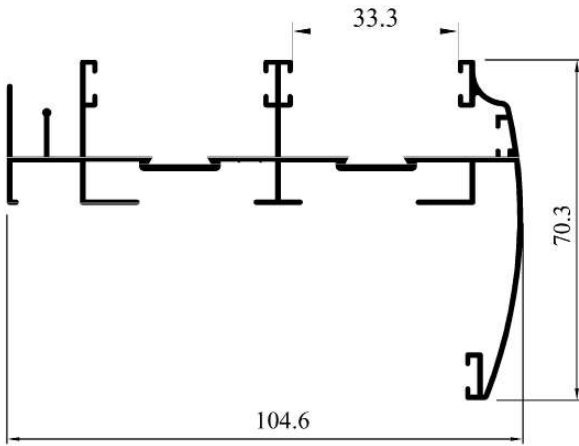

**10252**

**Est Weight: 1.150 kg/m**

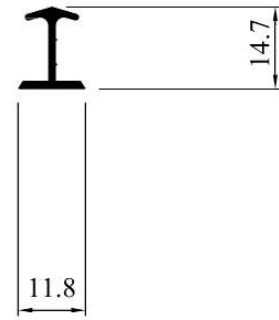

**10253**

**Est Weight: 0.119 kg/m**

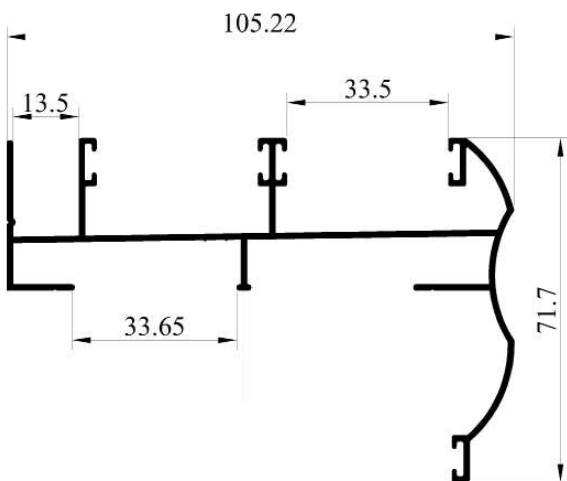

**10263**

**Est Weight: 1.170 kg/m**

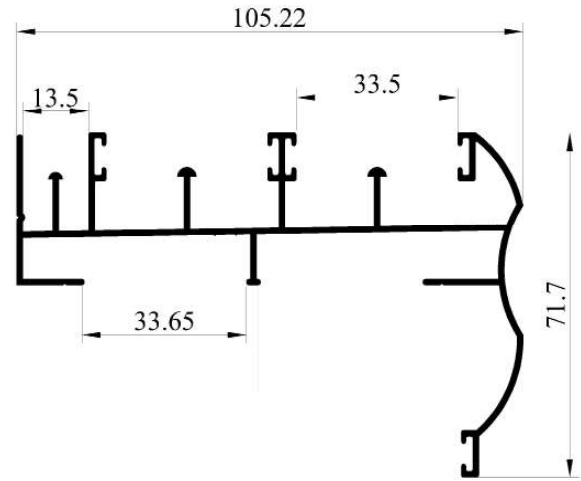

**10264**

**Est Weight: 1.324 kg/m**

سالكو

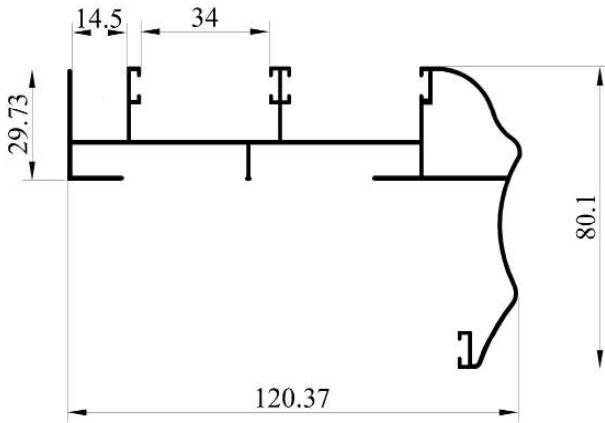

**20258**

**Est Weight: 1.213 kg/m**

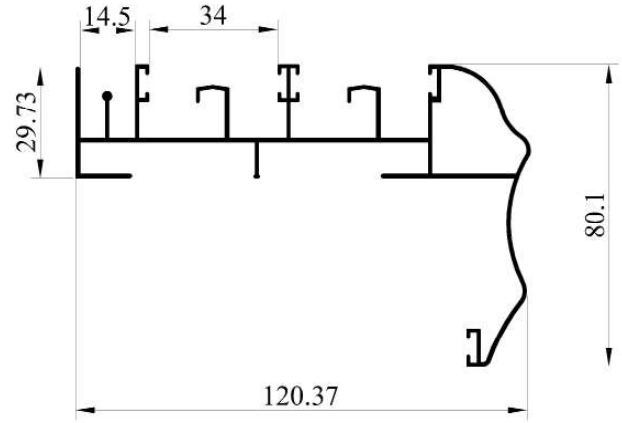

**20259**

**Est Weight: 1.402 kg/m**

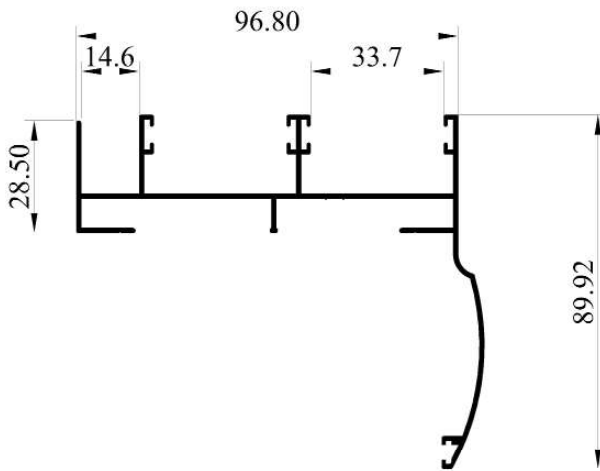

**10311**

**Est Weight: 1.160 kg/m**

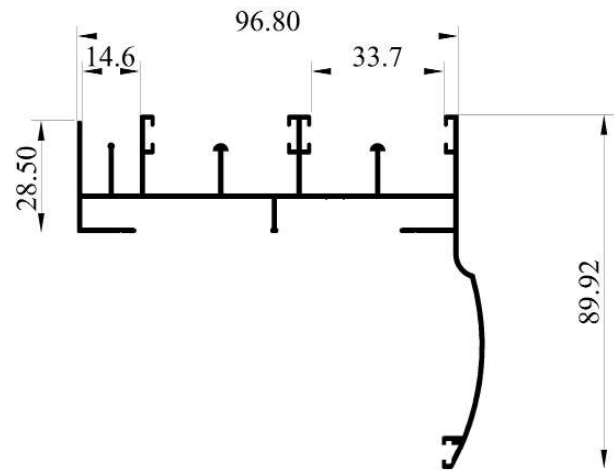

**10310**

**Est Weight: 1.317 kg/m**

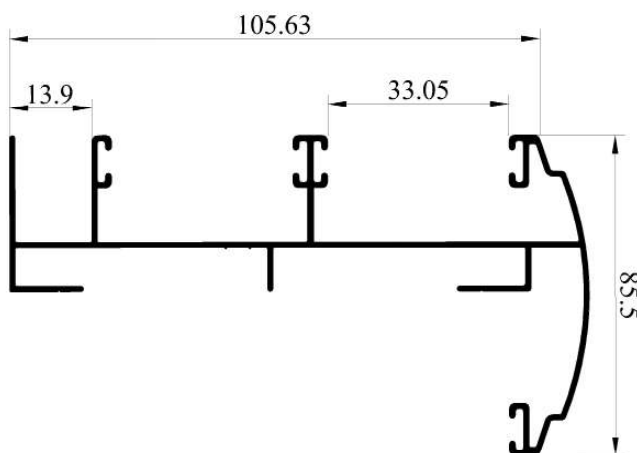

**10284**

**Est Weight: 0.990 kg/m**

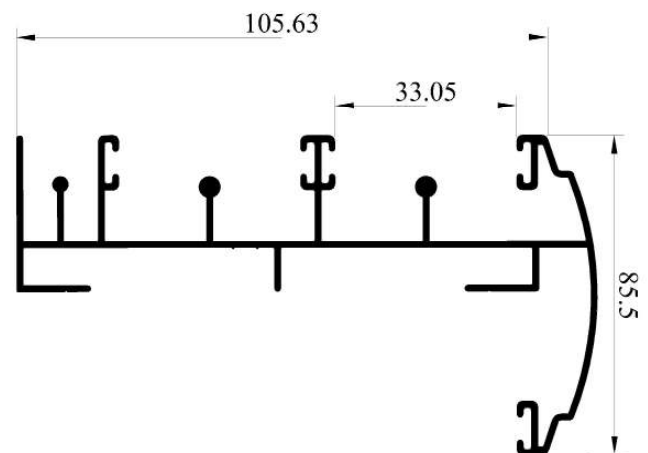

**10283**

**Est Weight: 1.220 kg/m**

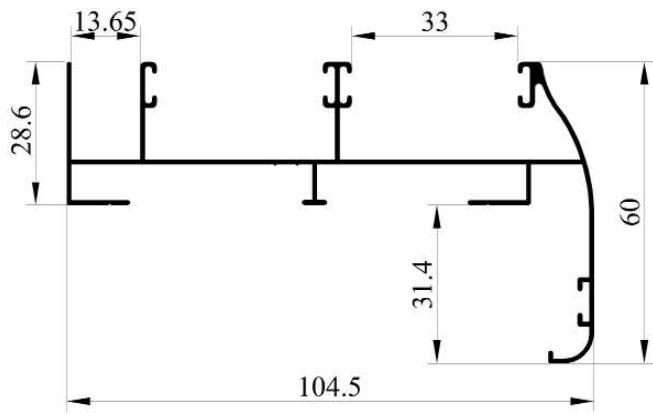

**10318**

**Est Weight: 0.826 kg/m**

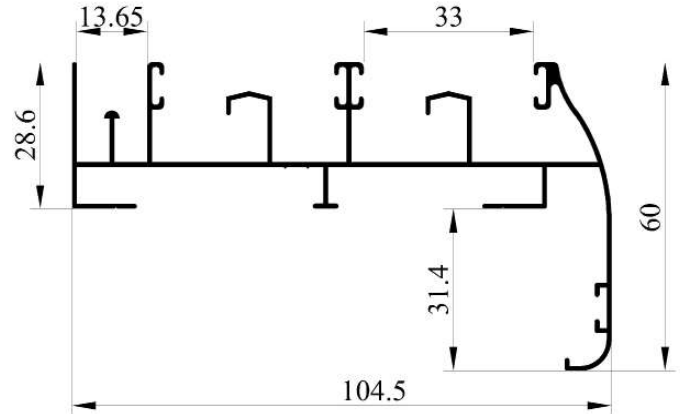

**10317**

**Est Weight: 0.972 kg/m**

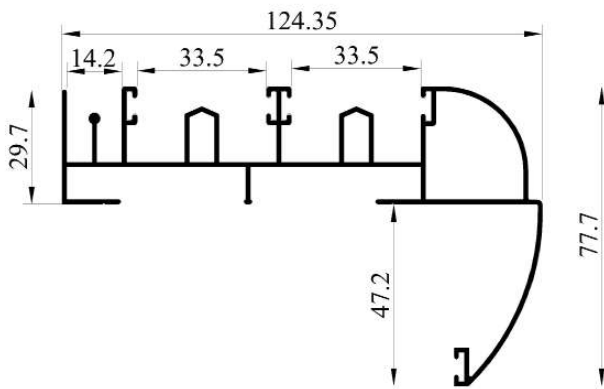

**20413**

**Est Weight: 1.580 kg/m**

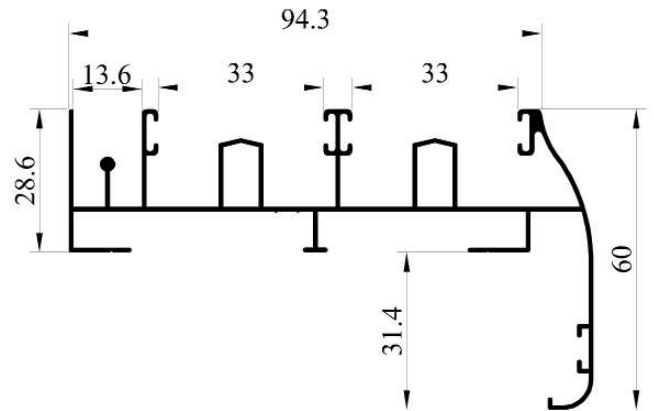

**20419**

**Est Weight: 1.024 kg/m**

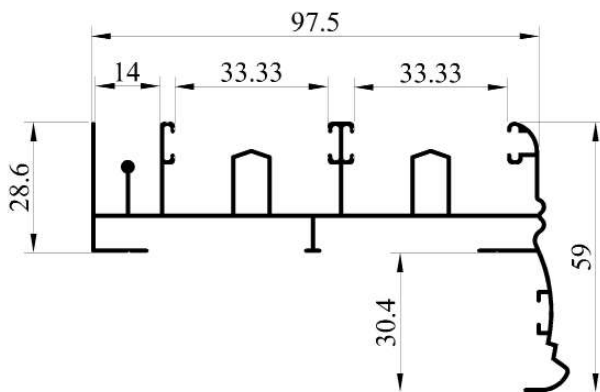

**20415**

**Est Weight: 0.970 kg/m**

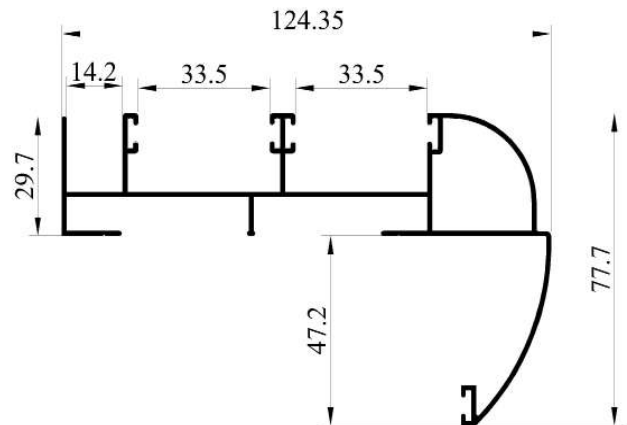

**20414**

**Est Weight: 1.317 kg/m**

# سحاب عريض

## Sliding 95-120mm

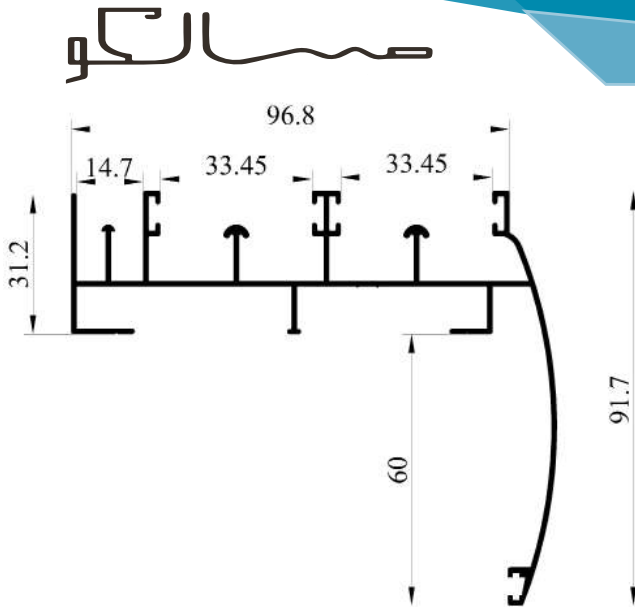

**10325**

**Est Weight: 1.322 kg/m**

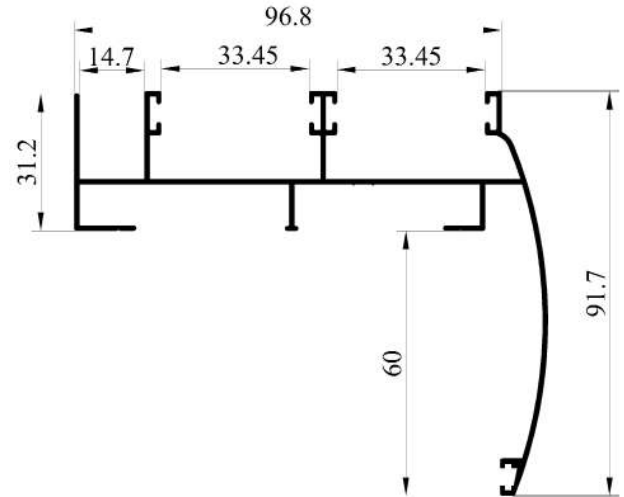

**10326**

**Est Weight: 1.149 kg/m**

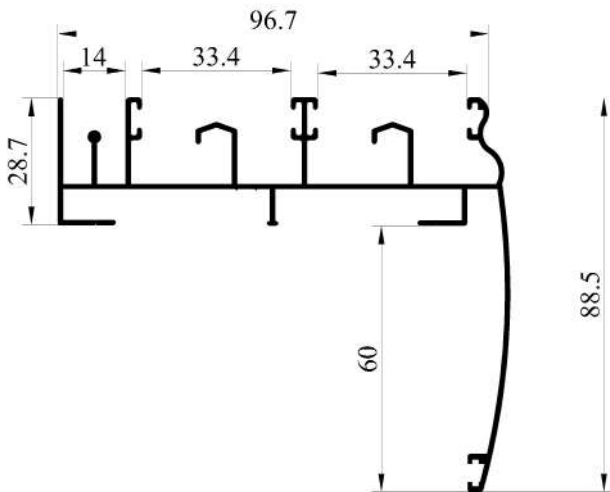

**10329**

**Est Weight: 1.284 kg/m**

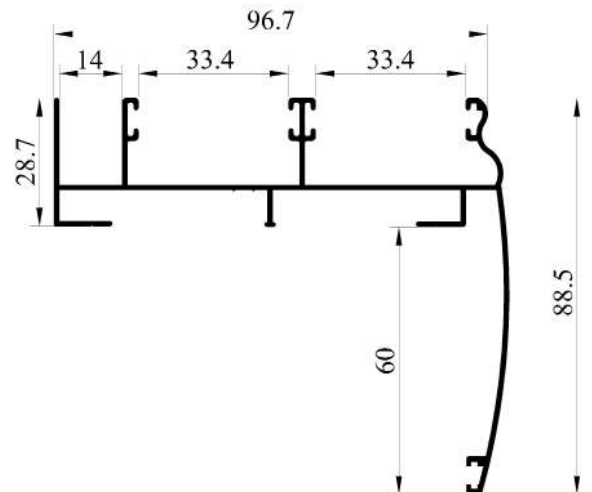

**10330**

**Est Weight: 1.086 kg/m**

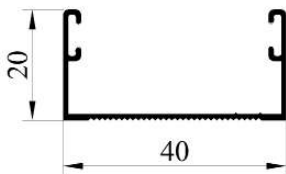

**10387**

**Est Weight: 0.237 kg/m**

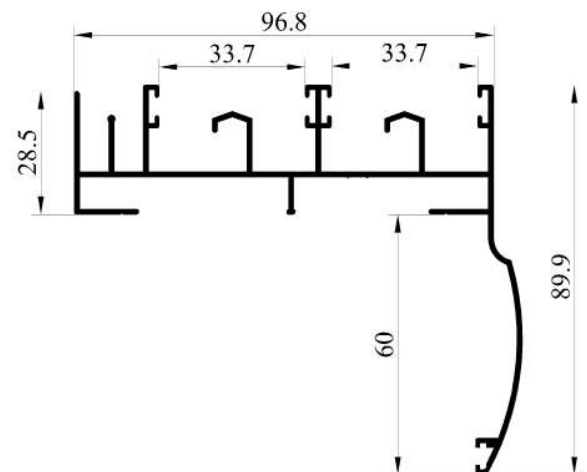

**10323**

**Est Weight: 1.368 kg/m**

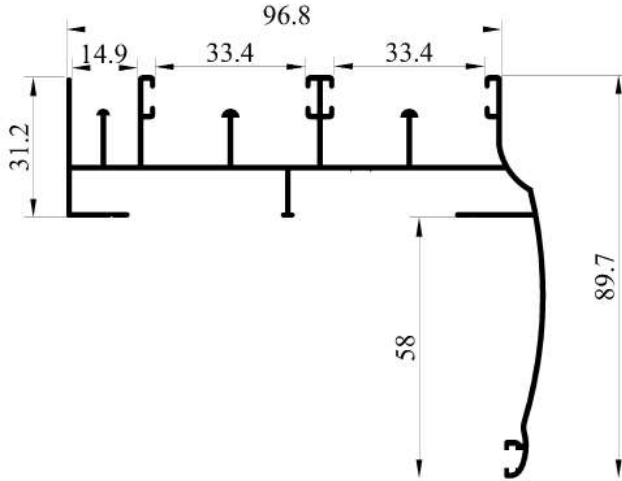

**10363**

**Est Weight: 1.262 kg/m**

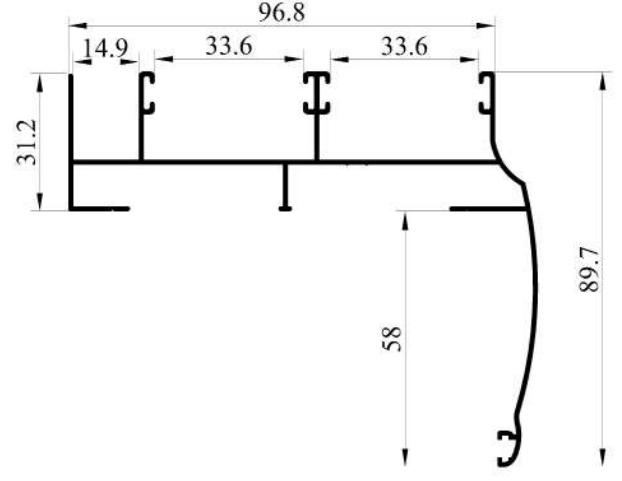

**10364**

**Est Weight: 1.027 kg/m**

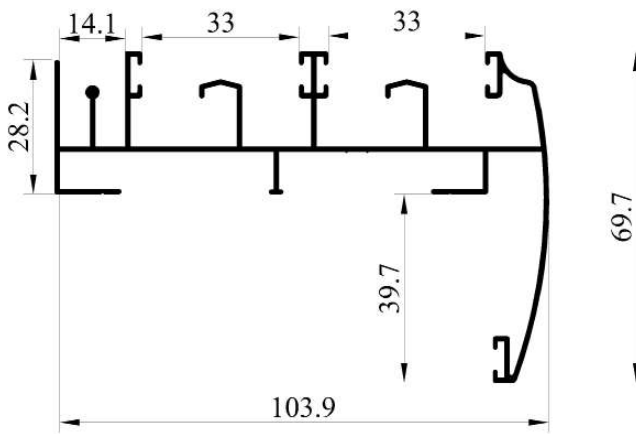

**10334**

**Est Weight: 1.211 kg/m**

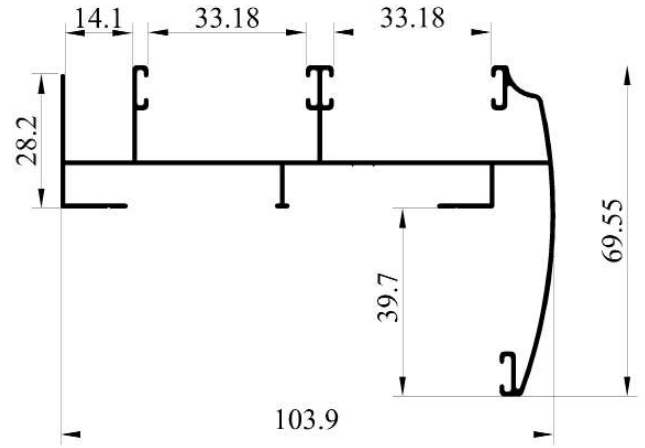

**10335**

**Est Weight: 0.883 kg/m**

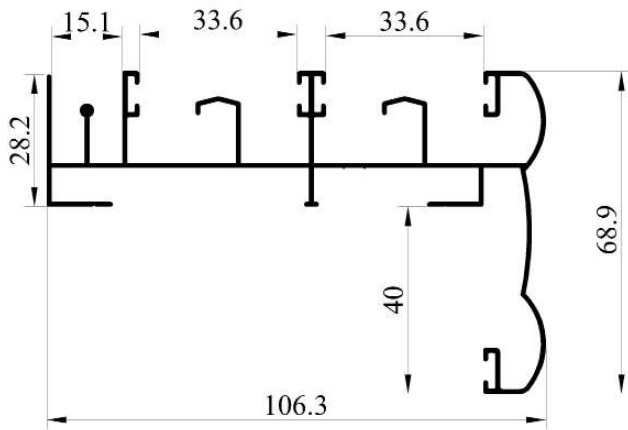

**10336**

**Est Weight: 1.149 kg/m**

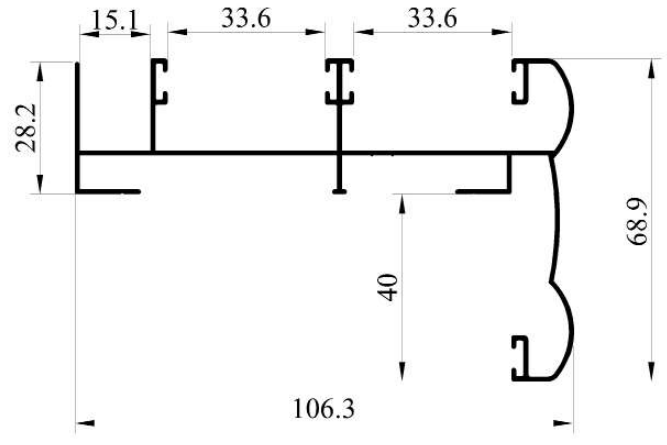

**10337**

**Est Weight: 0.975 kg/m**

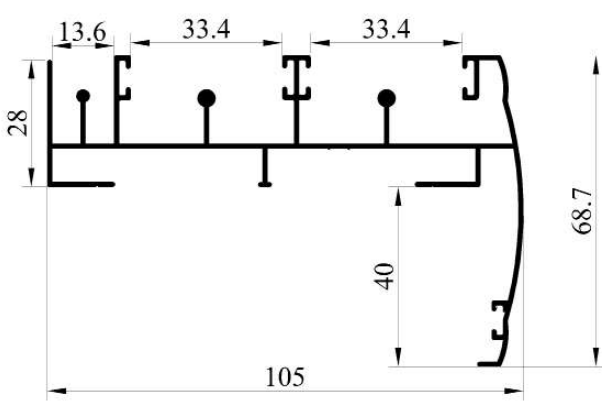

**10348**  
Est Weight: 1.189 kg/m

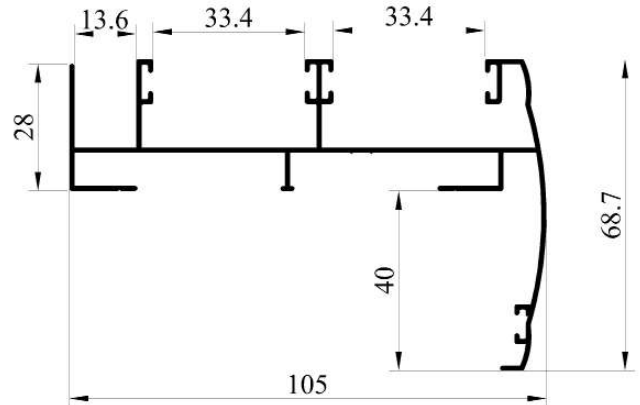

**10349**  
Est Weight: 1.029 kg/m

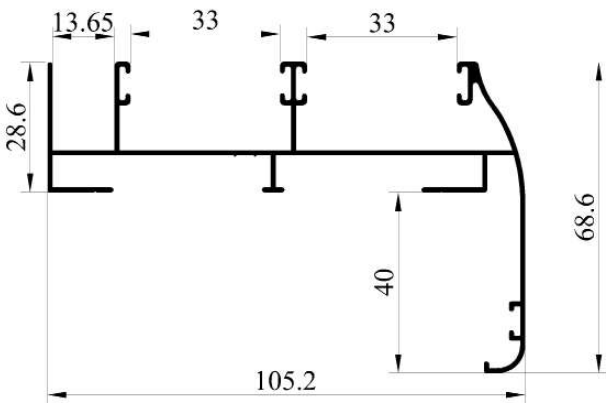

**10351**  
Est Weight: 0.975 kg/m

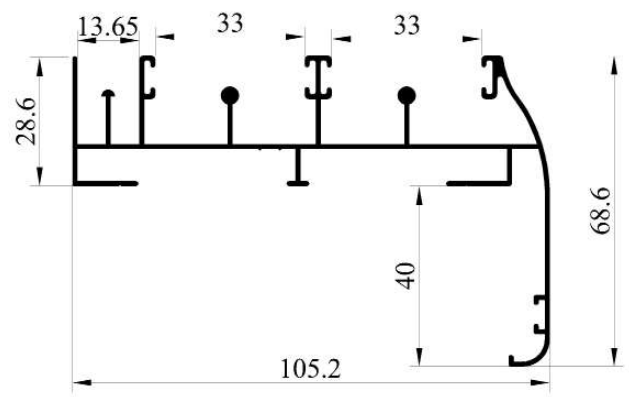

**10352**  
Est Weight: 1.125 kg/m

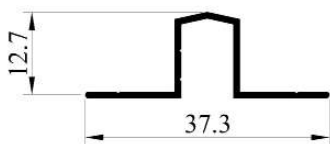

**10369**  
Est Weight: 0.160 kg/m

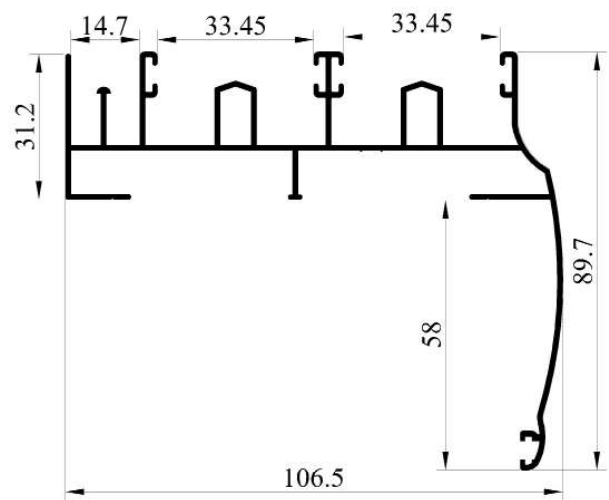

**20363**  
Est Weight: 1.365 kg/m

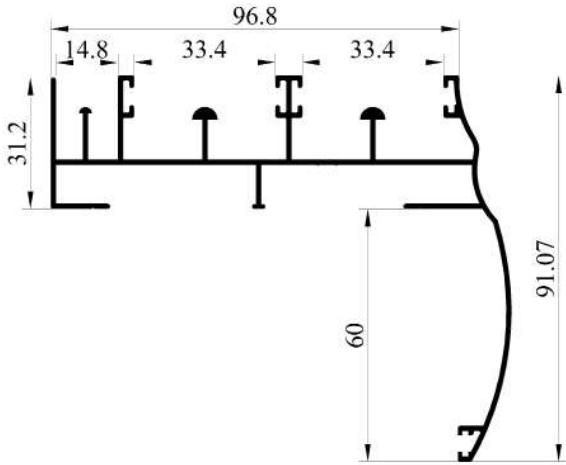

**10371**

**Est Weight: 1.338 kg/m**

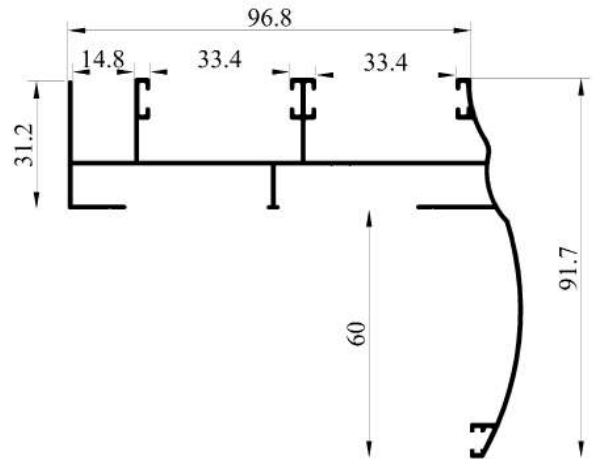

**10370**

**Est Weight: 1.075 kg/m**

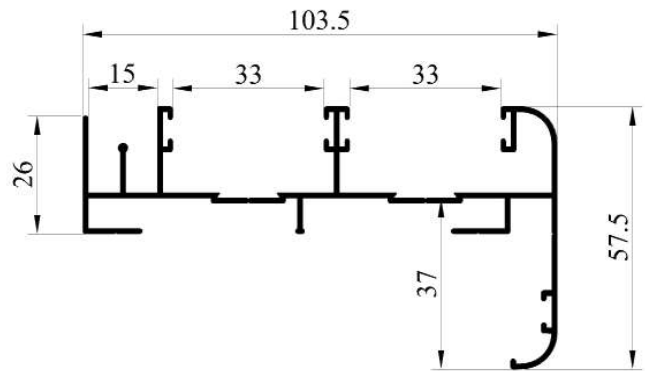
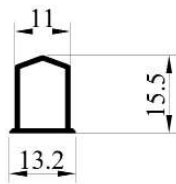

**20407**

**Est Weight: 0.127 kg/m**

**10396**

**Est Weight: 1.079 kg/m**

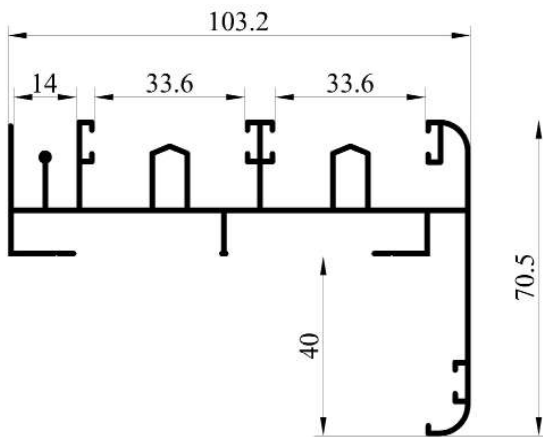

**20412**

**Est Weight: 1.392 kg/m**

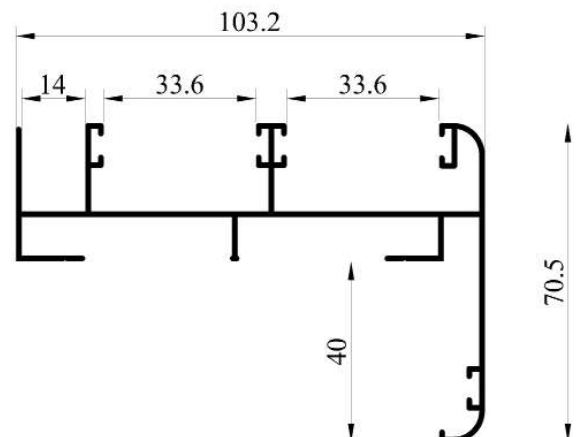

**10398**

**Est Weight: 1.118 kg/m**



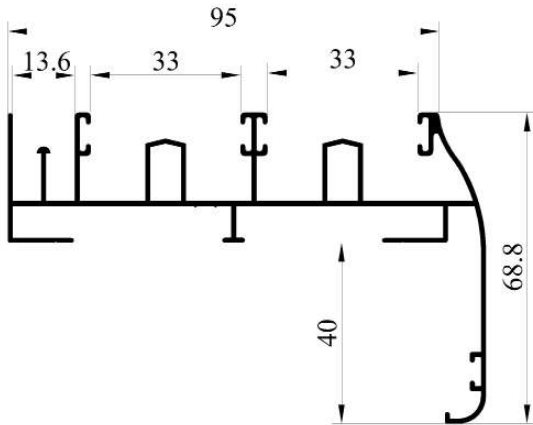

**20344**

**Est Weight: 1.208 kg/m**

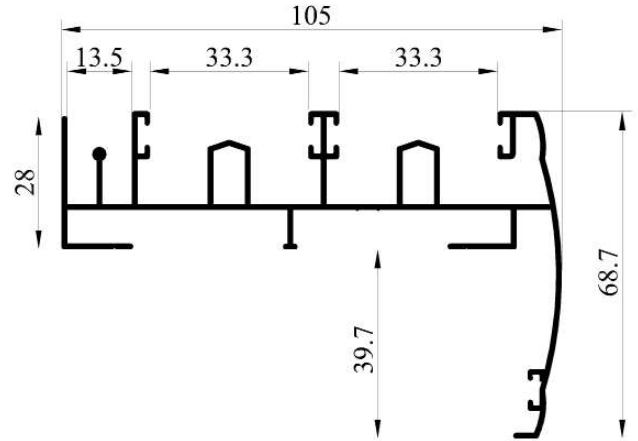

**20345**

**Est Weight: 1.360 kg/m**

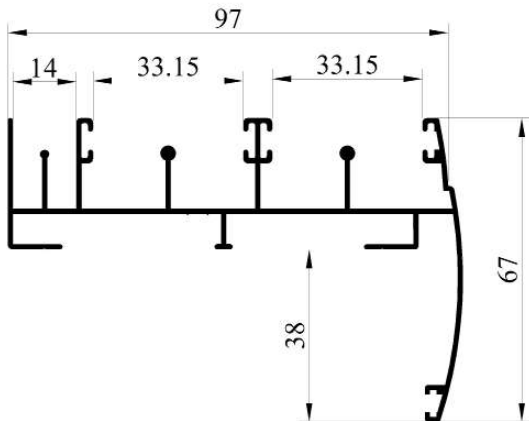

**10383**

**Est Weight: 1.108 kg/m**

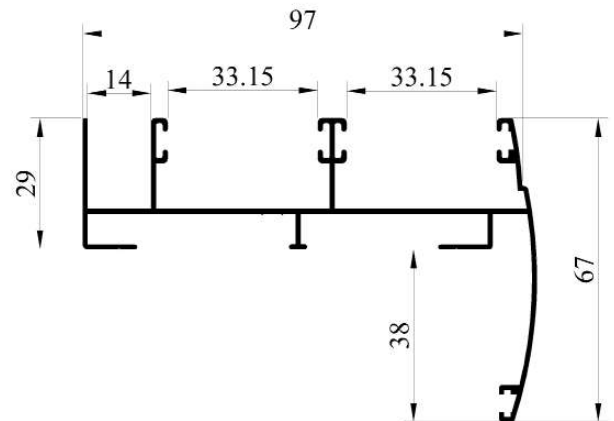

**10384**

**Est Weight: 0.877 kg/m**

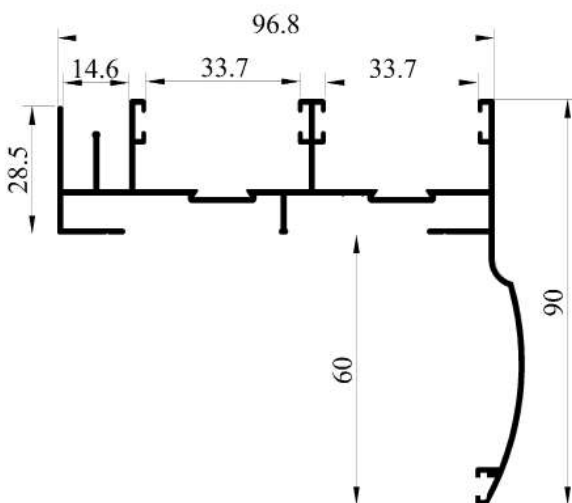

**10388**

**Est Weight: 1.238 kg/m**

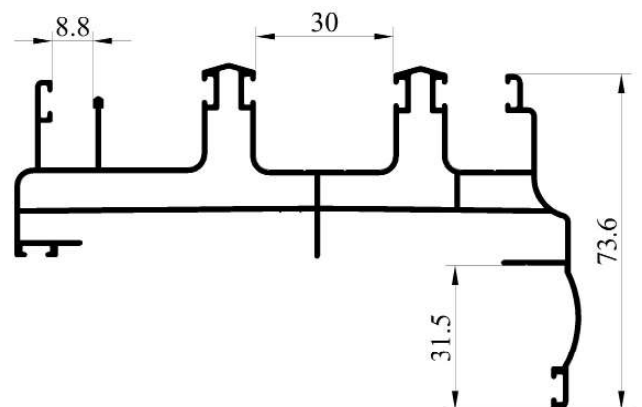

**20418**

**Est Weight: 1.785 kg/m**

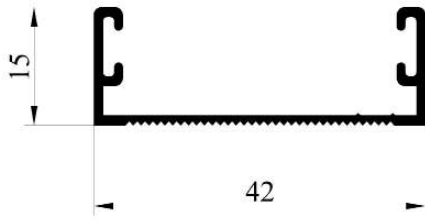

**10043**

**Est Weight: 0.272 kg/m**

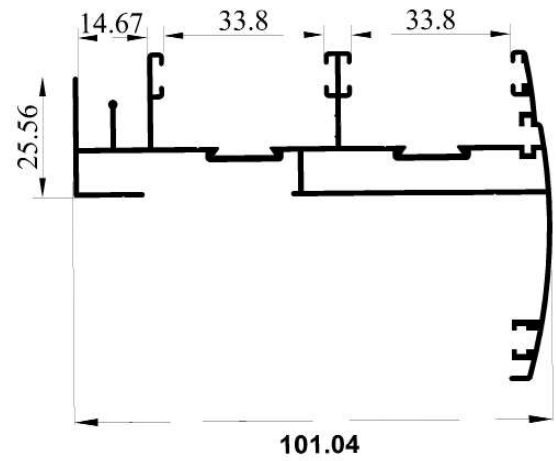

**20261**

**Est Weight: 1.189 kg/m**

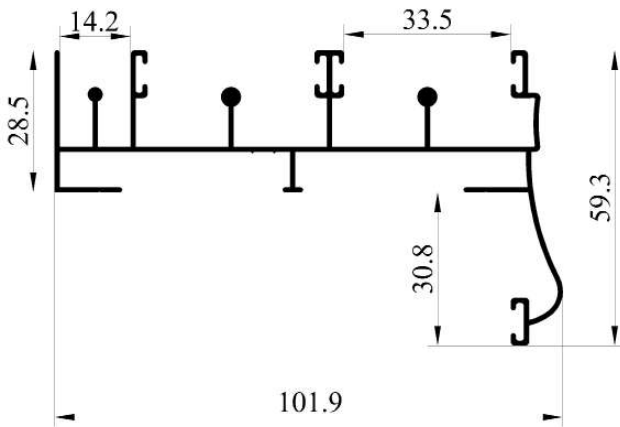

**10319**

**Est Weight: 0.997 kg/m**

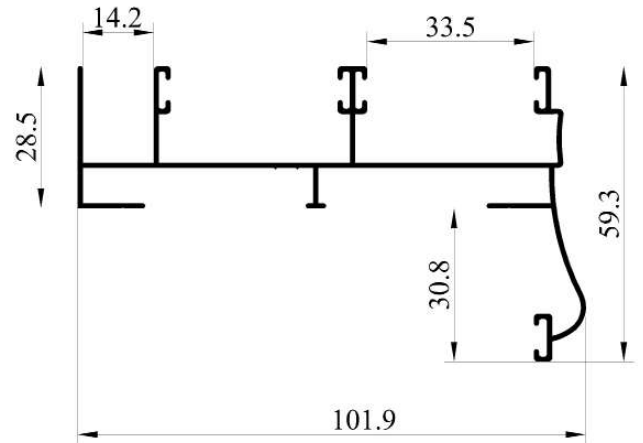

**10320**

**Est Weight: 0.840 kg/m**

سالكو

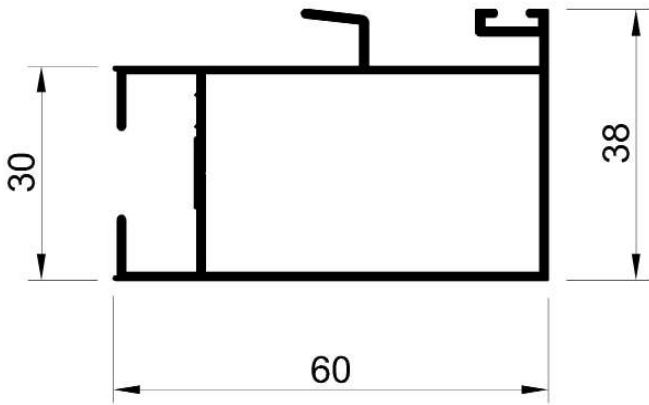

**20005**

**Est Weight: 0.676 kg/m**

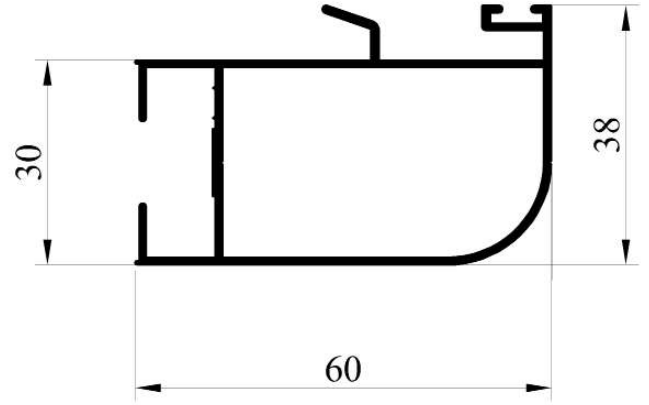

**20029**

**Est Weight: 0.617 kg/m**

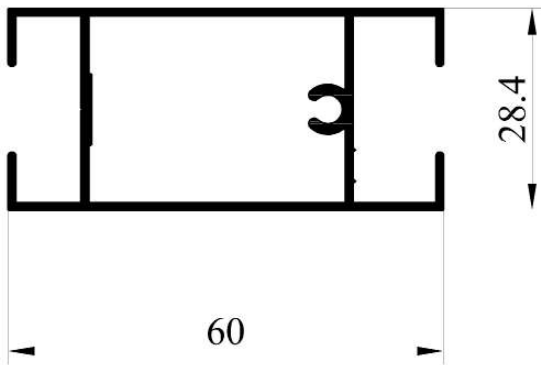

**20006**

**Est Weight: 0.633 kg/m**

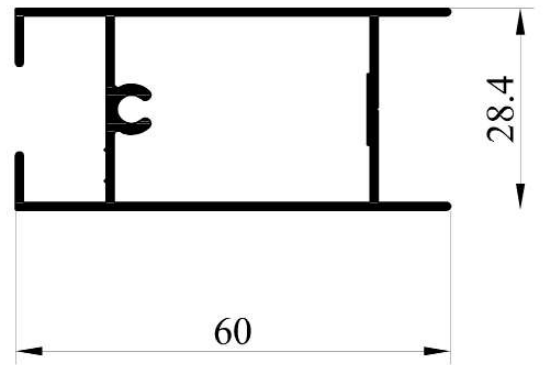

**20031**

**Est Weight: 0.611 kg/m**

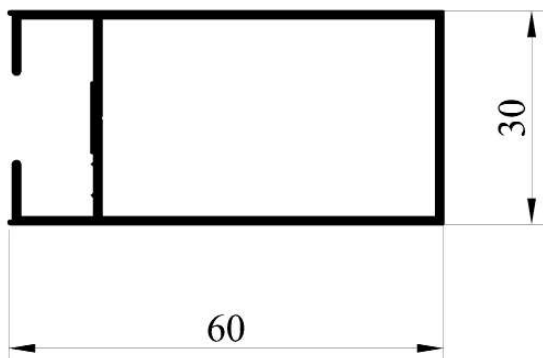

**20007**

**Est Weight: 0.565 kg/m**

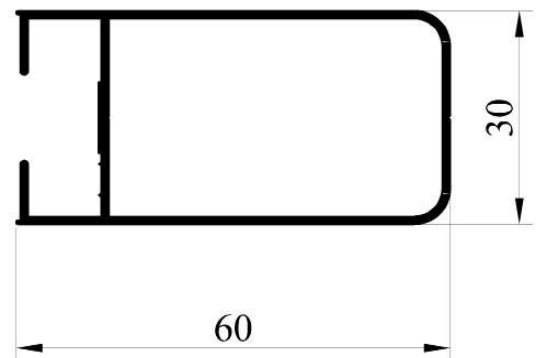

**20030**

**Est Weight: 0.550 kg/m**

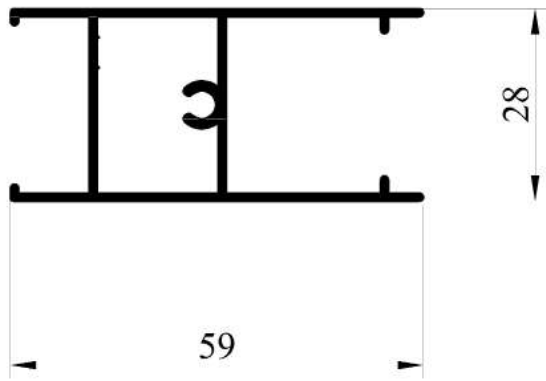

**20170**  
Est Weight: 0.617 kg/m

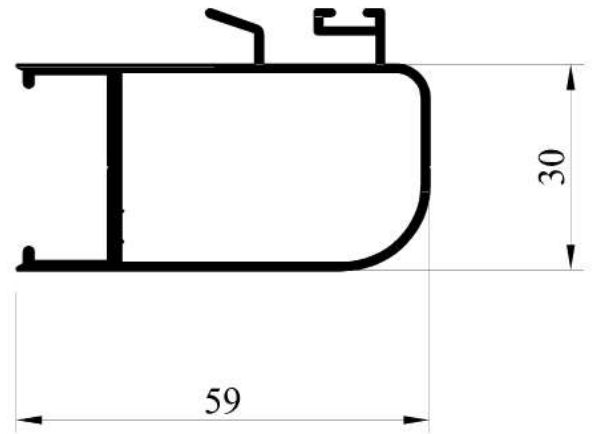

**20171**  
Est Weight: 0.744 kg/m

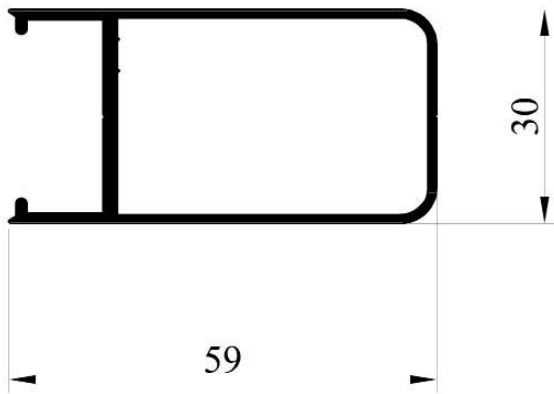

**20172**  
Est Weight: 0.640 kg/m

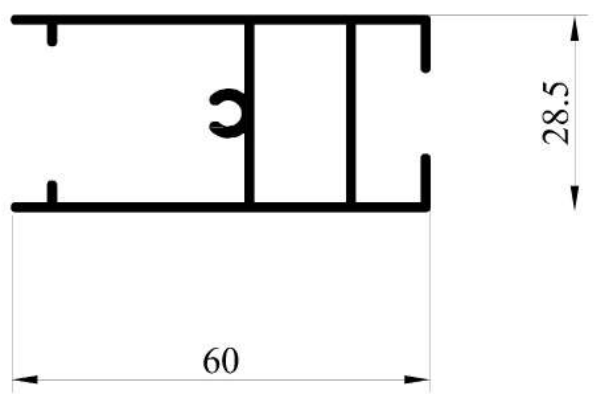

**20125**  
Est Weight: 0.687 kg/m

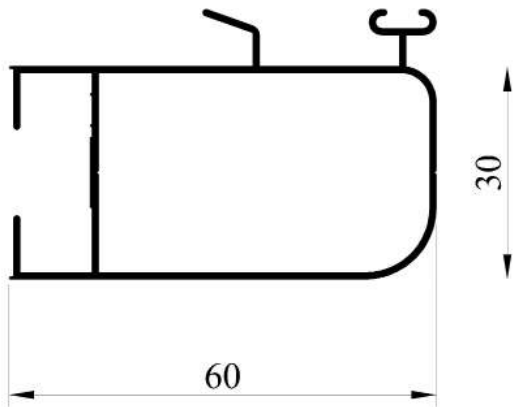

**20249**  
Est Weight: 0.570 kg/m

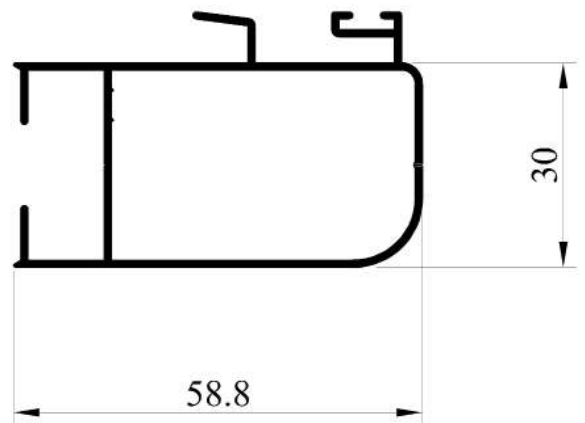

**20185**  
Est Weight: 0.617 kg/m

سالكو

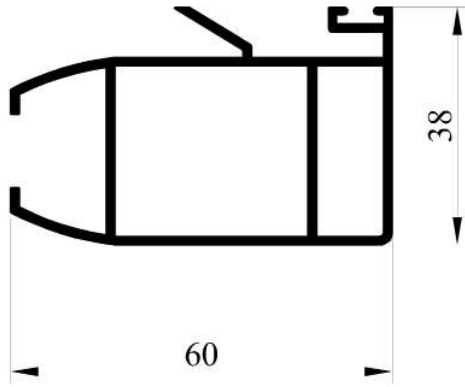

**20102**

Est Weight: 0.920 kg/m

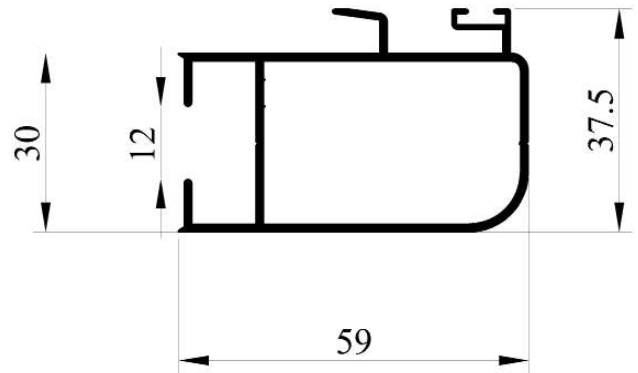

**20186**

Est Weight: 0.852 kg/m

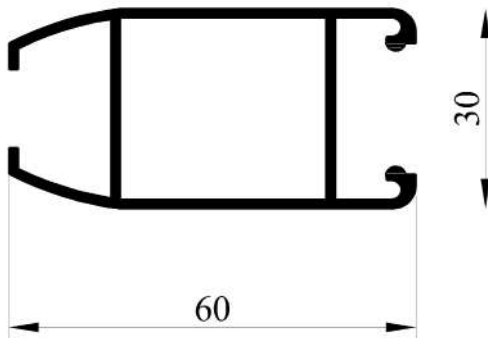

**20104**

Est Weight: 0.748 kg/m

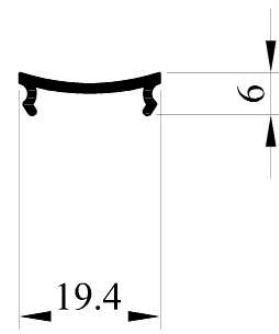

**10087**

Est Weight: 0.097 kg/m

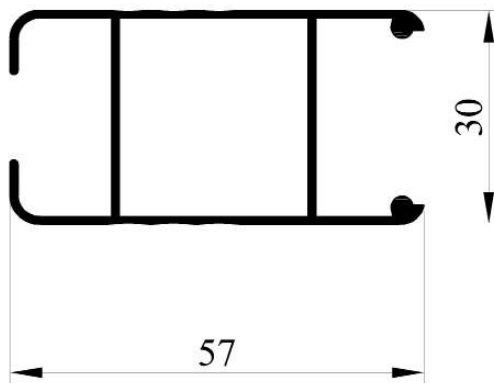

**20105**

Est Weight: 0.535 kg/m

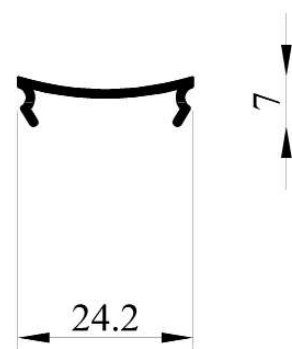

**10086**

Est Weight: 0.110 kg/m

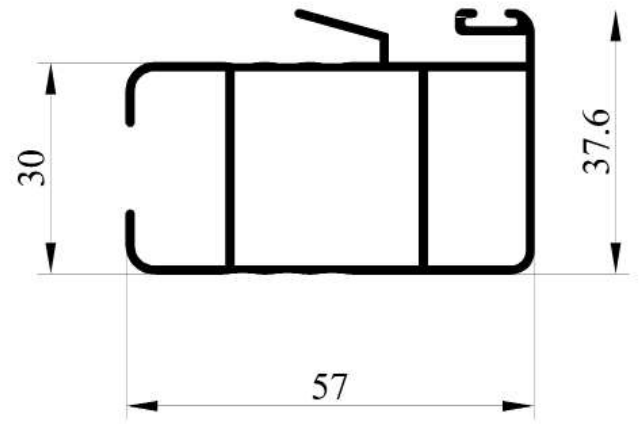

**20103**

**Est Weight: 0.698 kg/m**

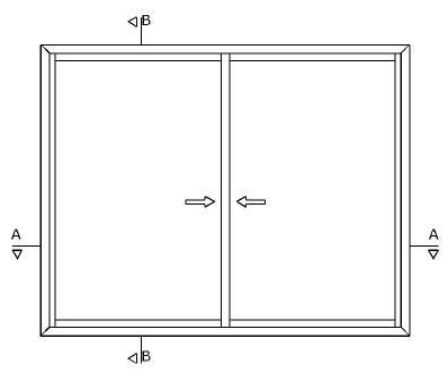
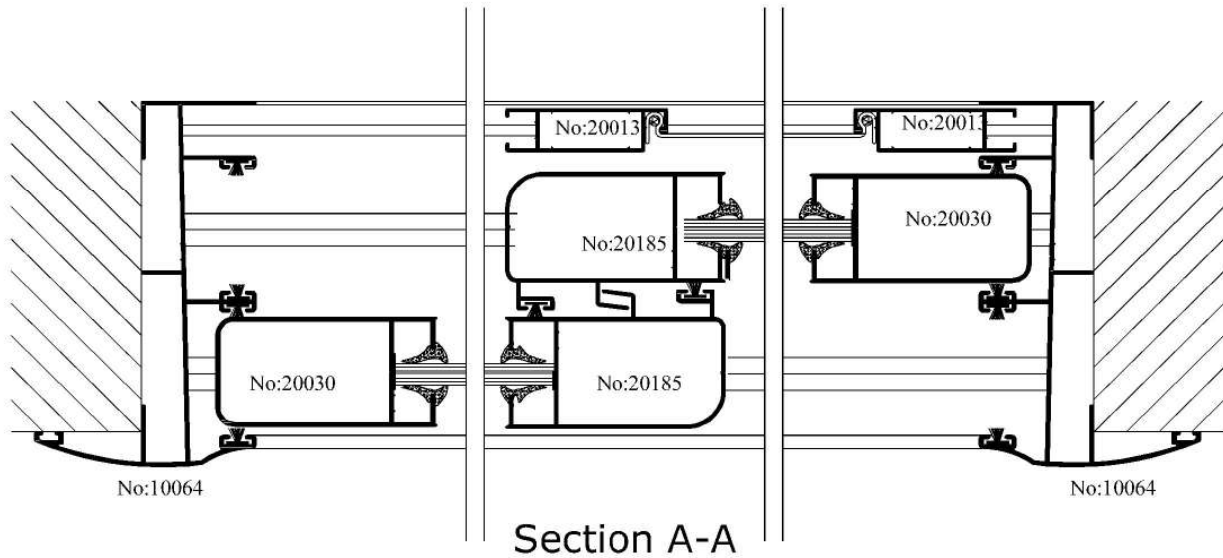

نافذة سحاب عريض

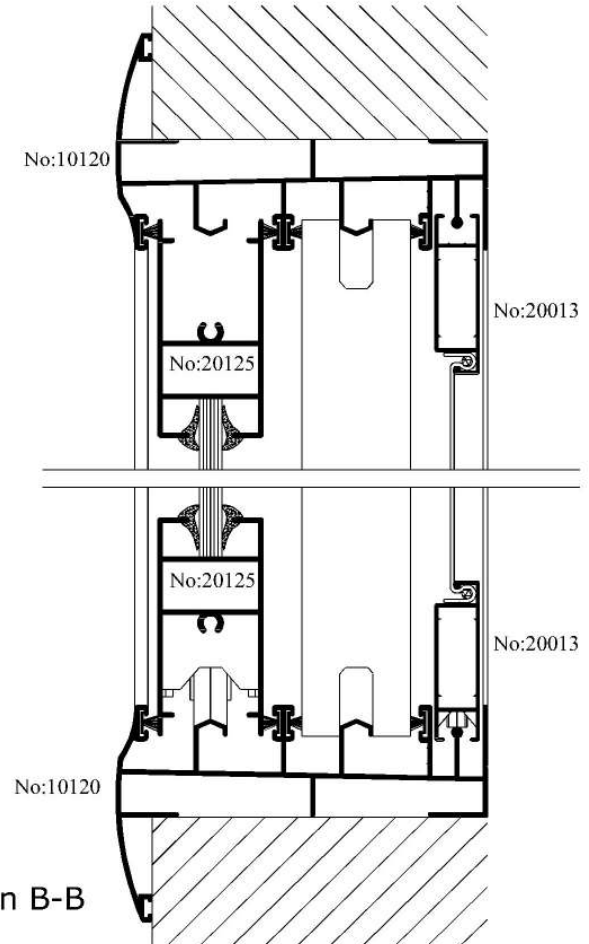

# سحاب ضيق ومعدل Sliding 75-98 mm

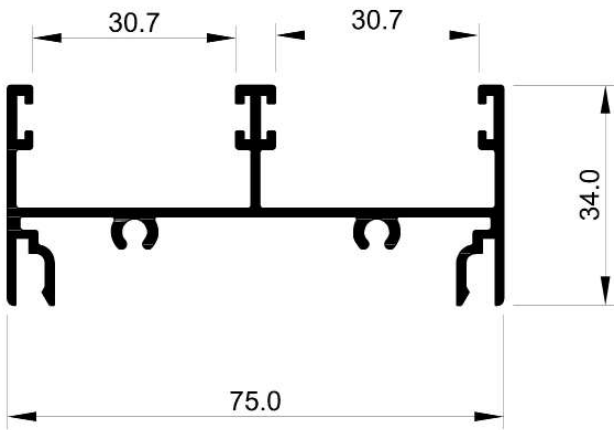

**10093**

**Est Weight: 0.866 kg/m**

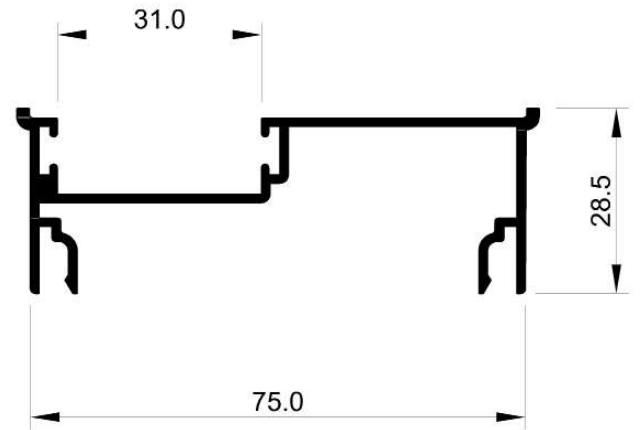

**10099**

**Est Weight: 0.662 kg/m**

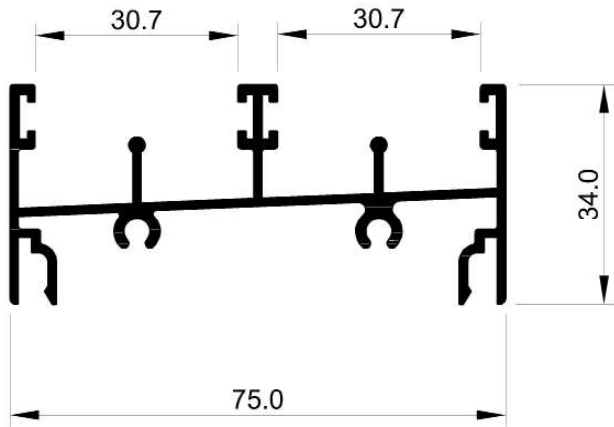

**10094**

**Est Weight: 0.963 kg/m**

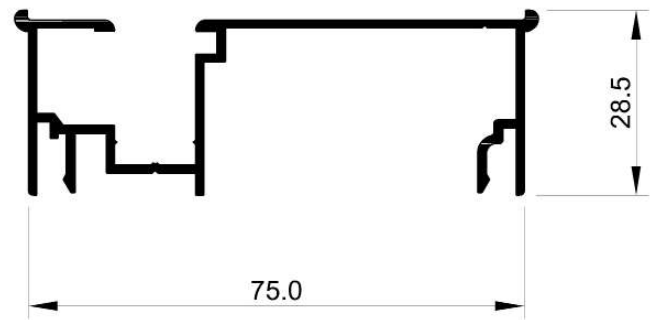

**10148**

**Est Weight: 0.712 kg/m**

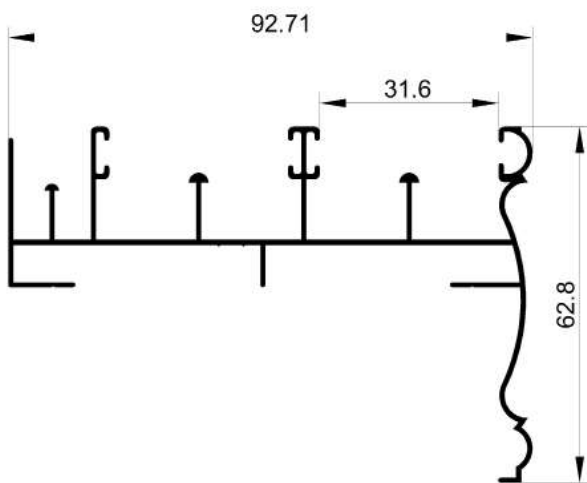

**10296**

**Est Weight: 0.813 kg/m**

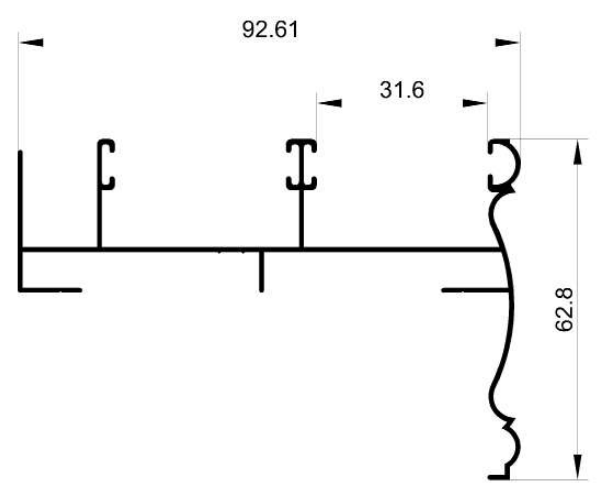

**10297**

**Est Weight: 0.710 kg/m**



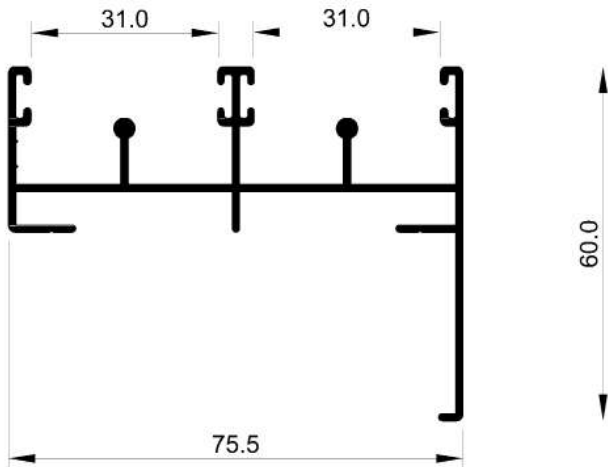

**10024**

**Est Weight: 0.769 kg/m**

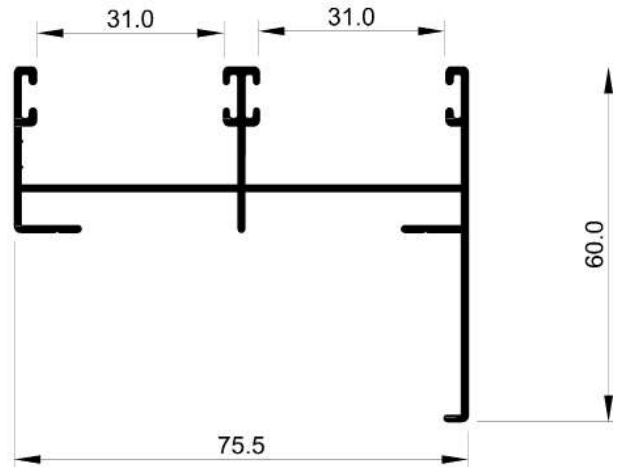

**10023**

**Est Weight: 0.573 kg/m**

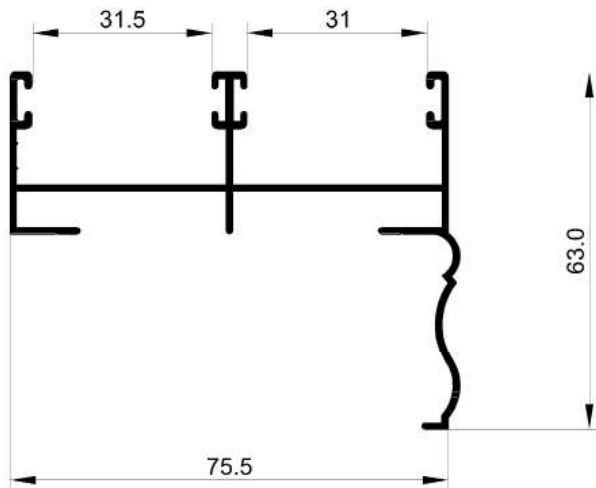

**10121**

**Est Weight: 0.654 kg/m**

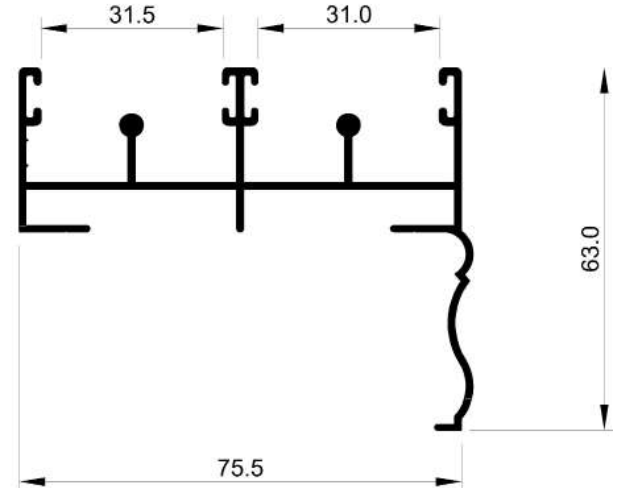

**10122**

**Est Weight: 0.720 kg/m**

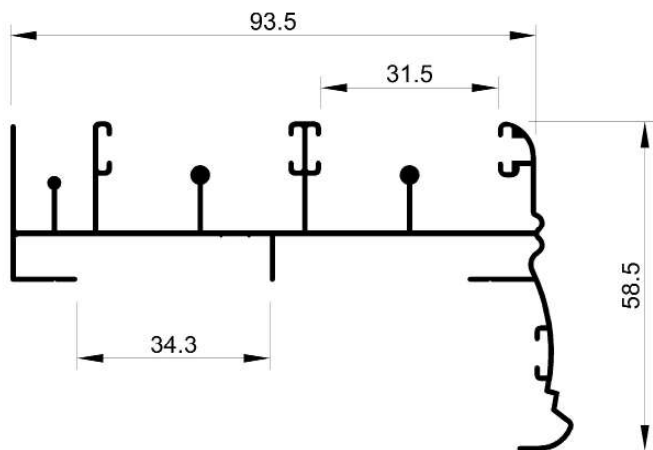

**10272**

**Est Weight: 0.816 kg/m**

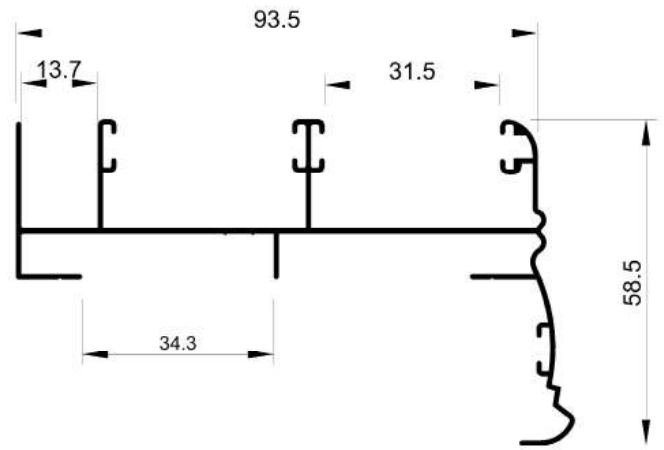

**10273**

**Est Weight: 0.725 kg/m**

# سحاب ضيق ومعدل Sliding 75-98 mm

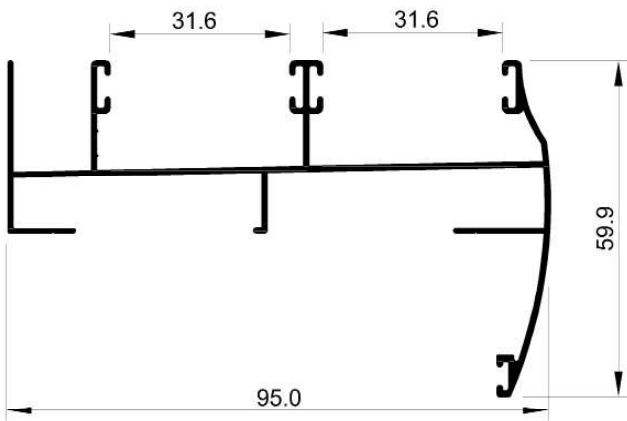

**10131**

**Est Weight: 0.750 kg/m**

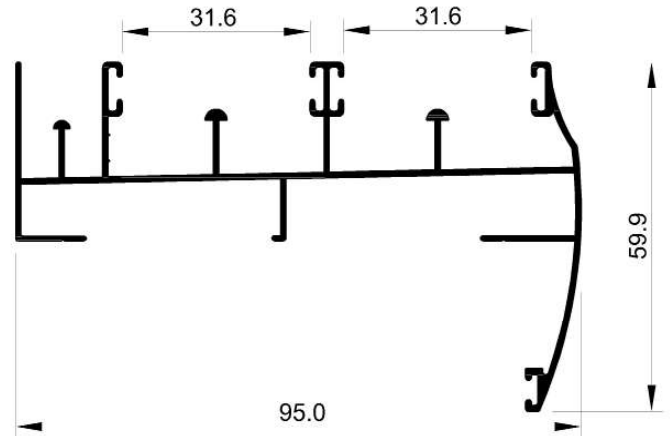

**10130**

**Est Weight: 0.880 kg/m**

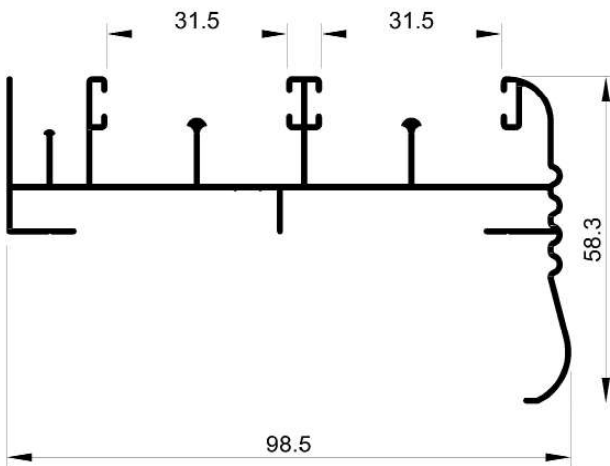

**10184**

**Est Weight: 0.778 kg/m**

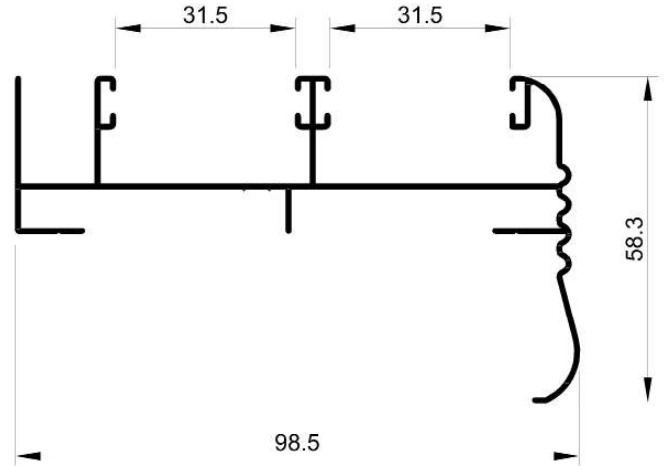

**10183**

**Est Weight: 0.648 kg/m**

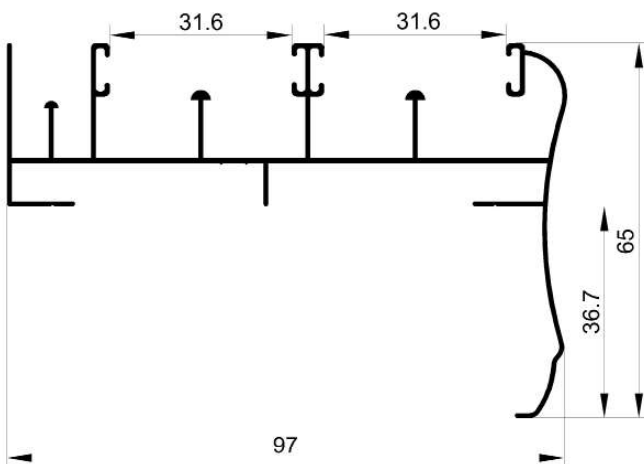

**10345**

**Est Weight: 0.826 kg/m**

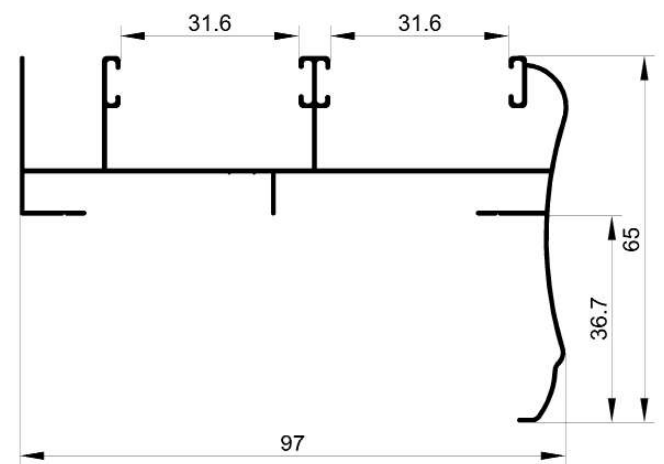

**10346**

**Est Weight: 0.726 kg/m**

سلك

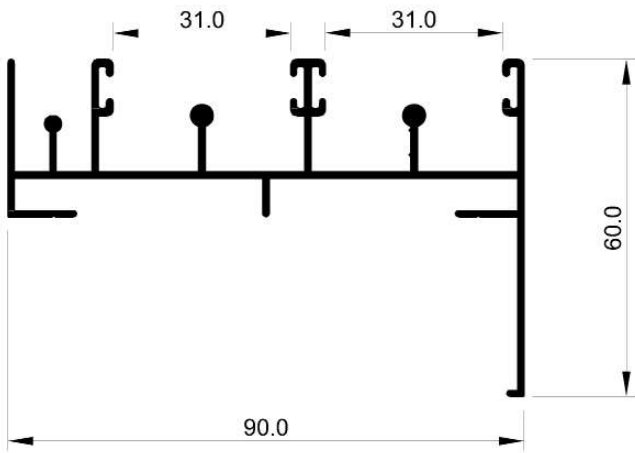

**10007**

**Est Weight: 0.816 kg/m**

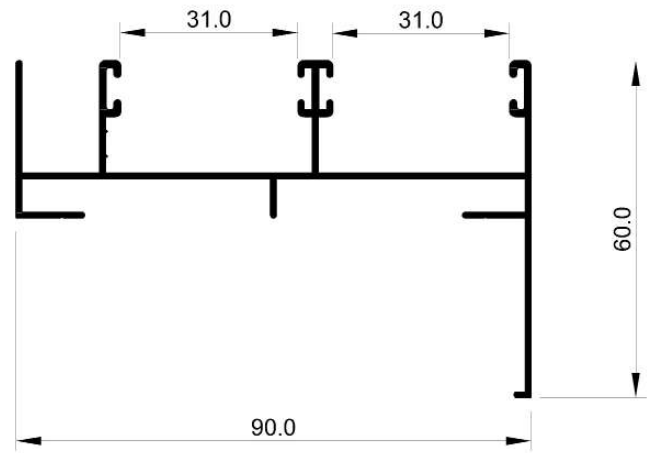

**10008**

**Est Weight: 0.725 kg/m**

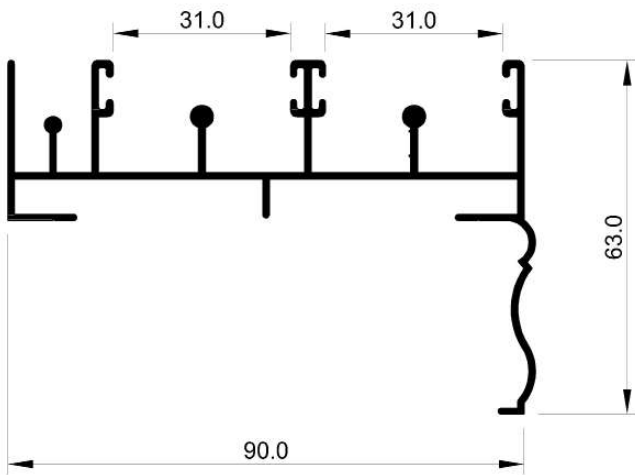

**10048**

**Est Weight: 0.816 kg/m**

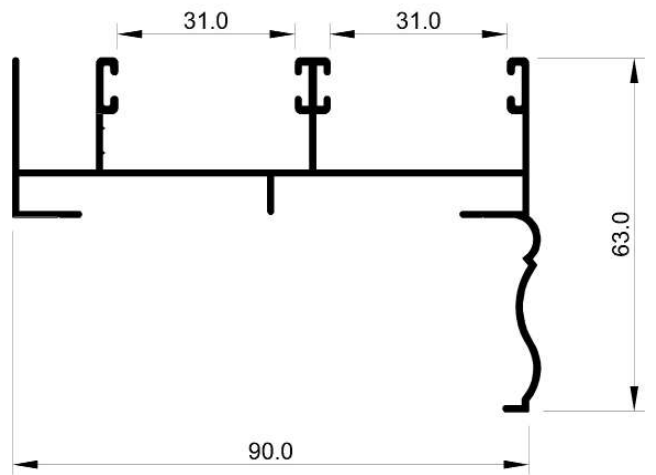

**10047**

**Est Weight: 0.725 kg/m**

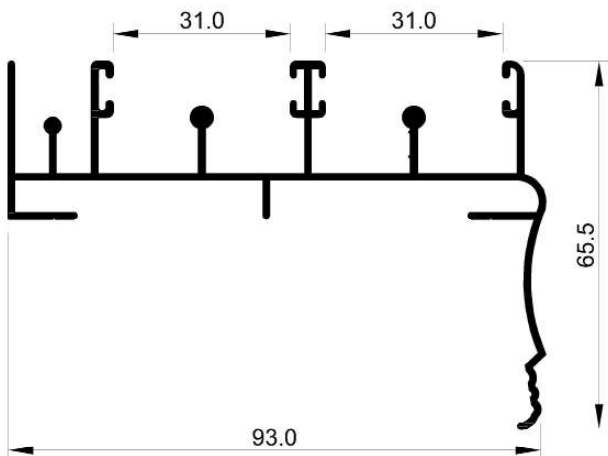

**10089**

**Est Weight: 1.023 kg/m**

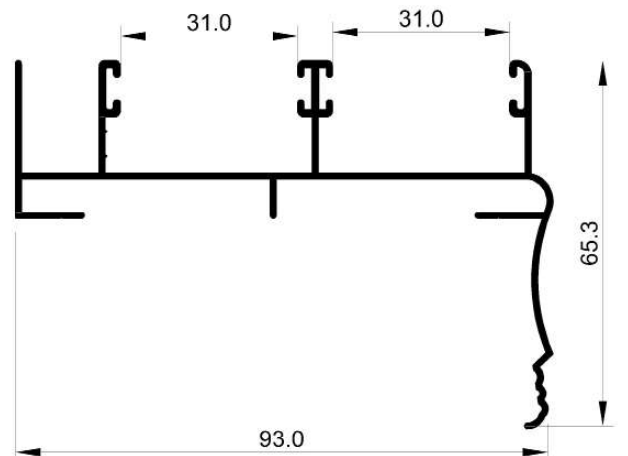

**10088**

**Est Weight: 0.803 kg/m**

# سحاب ضيق ومعدل Sliding 75-98 mm

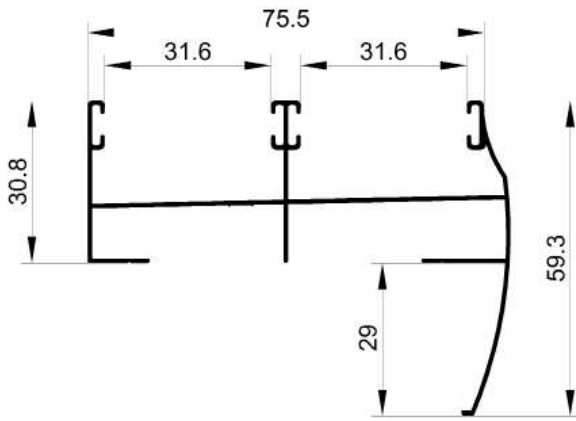

**10342**

**Est Weight: 0.626 kg/m**

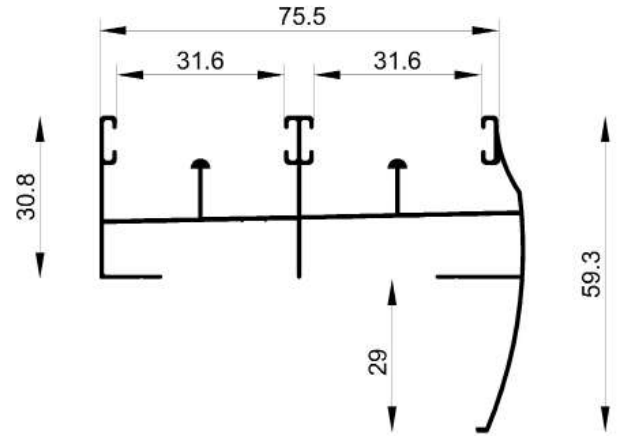

**10343**

**Est Weight: 0.696 kg/m**

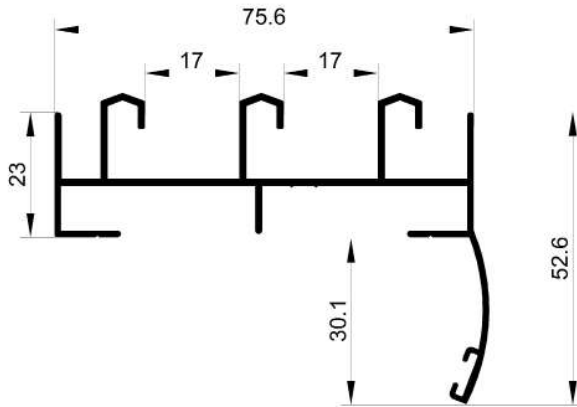

**10377**

**Est Weight: 0.897 kg/m**

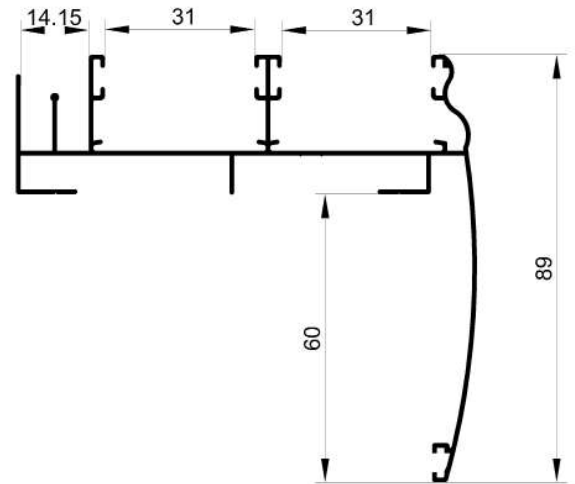

**10368**

**Est Weight: 0.951 kg/m**

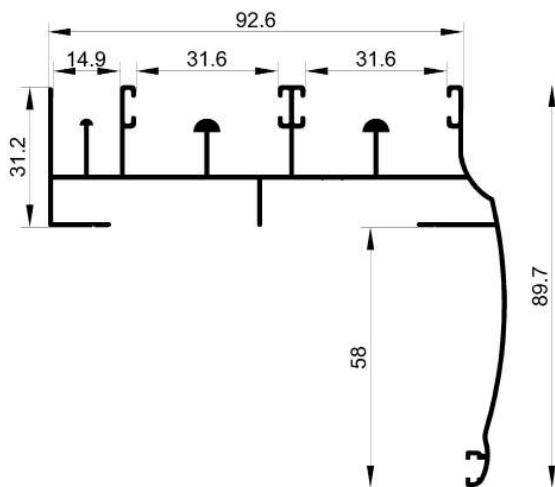

**10379**

**Est Weight: 1.125 kg/m**

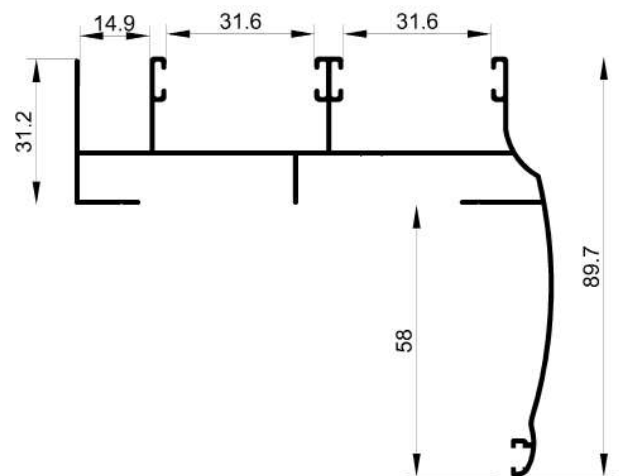

**10378**

**Est Weight: 0.957 kg/m**

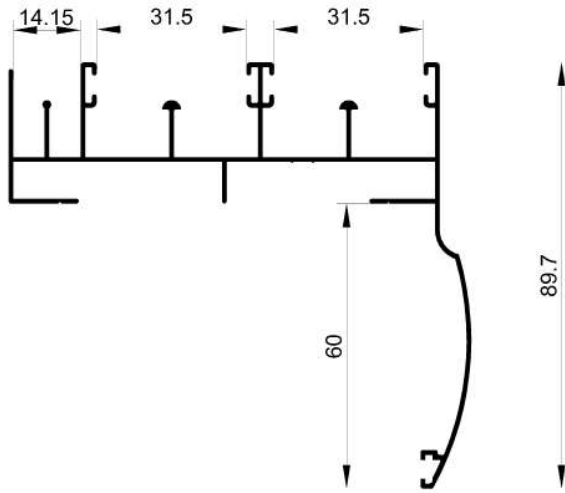

**10360**

**Est Weight: 1.000 kg/m**

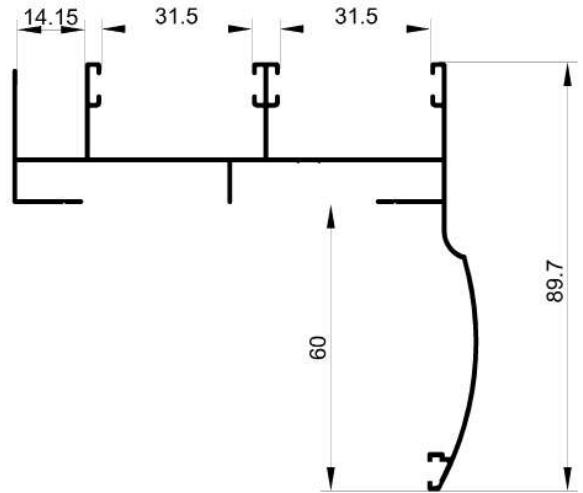

**10361**

**Est Weight: 0.875 kg/m**

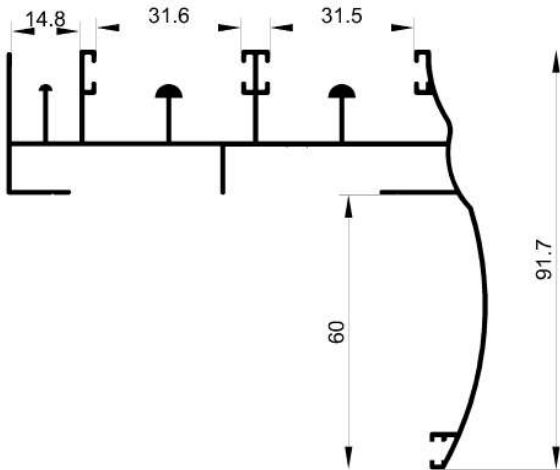

**10373**

**Est Weight: 1.214 kg/m**

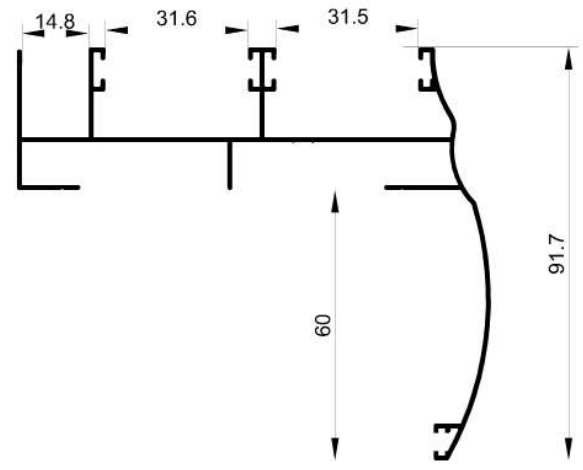

**10372**

**Est Weight: 1.035 kg/m**

# سحاب ضيق ومعدل Sliding 75-98 mm

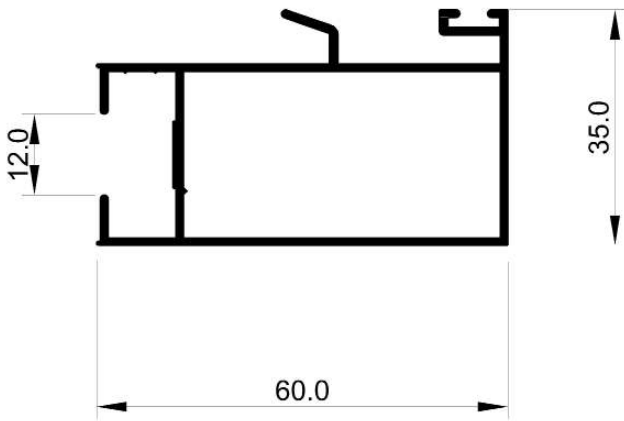

**20021**

**Est Weight: 0.661 kg/m**

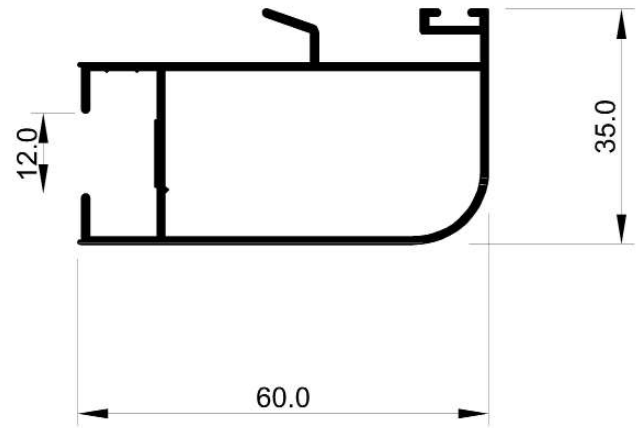

**20120**

**Est Weight: 0.600 kg/m**



**20023**

**Est Weight: 0.551 kg/m**

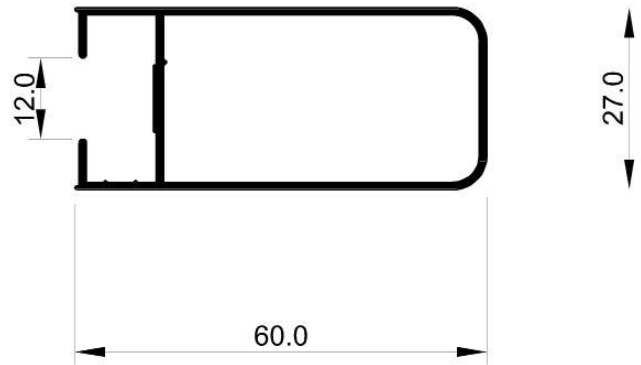

**20121**

**Est Weight: 0.533 kg/m**

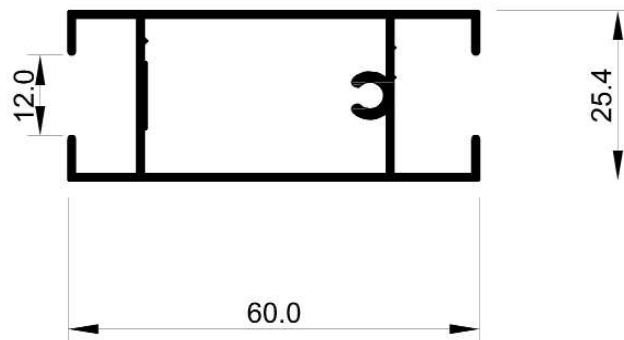

**20022**

**Est Weight: 0.583 kg/m**

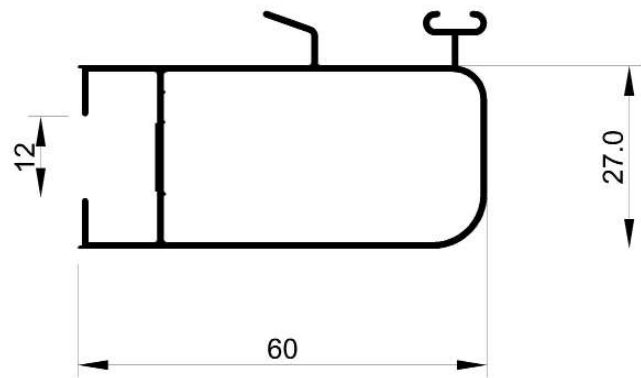

**20250**

**Est Weight: 0.522 kg/m**

سالكو

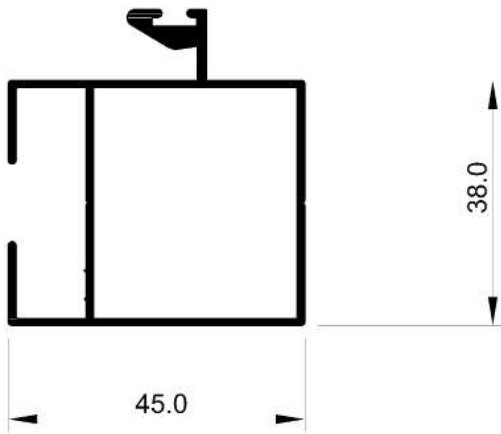

**20124**

Est Weight: 0.687 kg/m

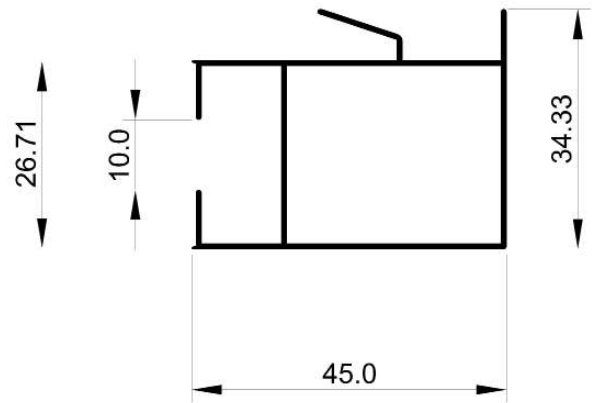

**20246**

Est Weight: 0.393 kg/m

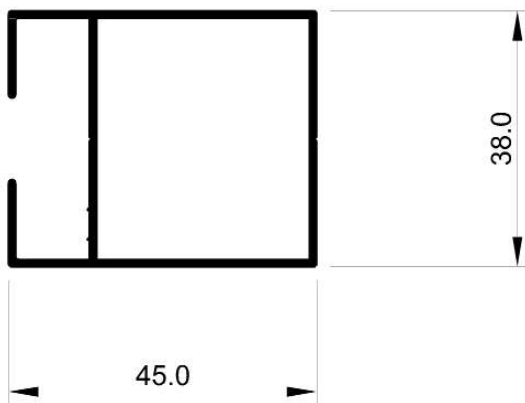

**20123**

Est Weight: 0.550 kg/m

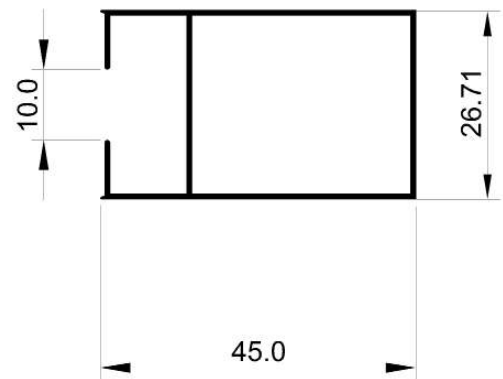

**20247**

Est Weight: 0.366 kg/m

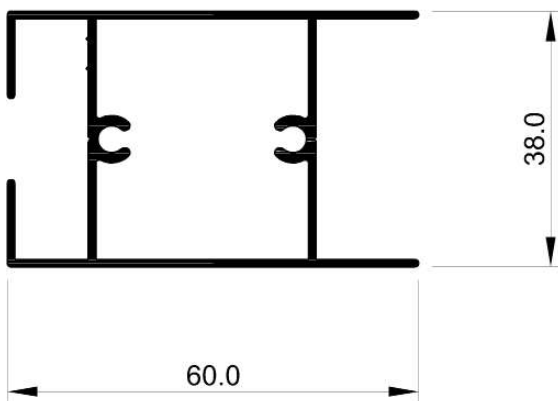

**20122**

Est Weight: 0.729 kg/m

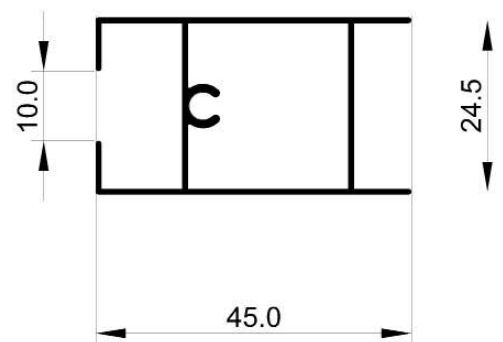

**20248**

Est Weight: 0.369 kg/m

# سحاب ضيق ومعدل Sliding 75-98 mm

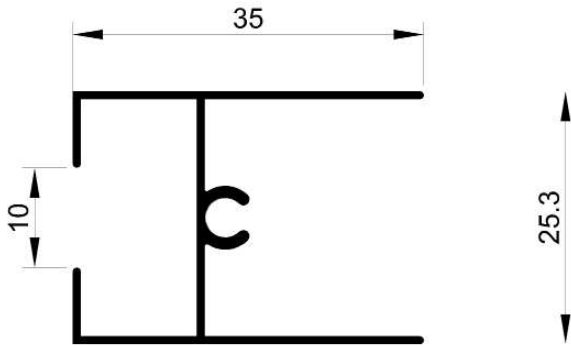

**10257**

Est Weight: 0.243 kg/m

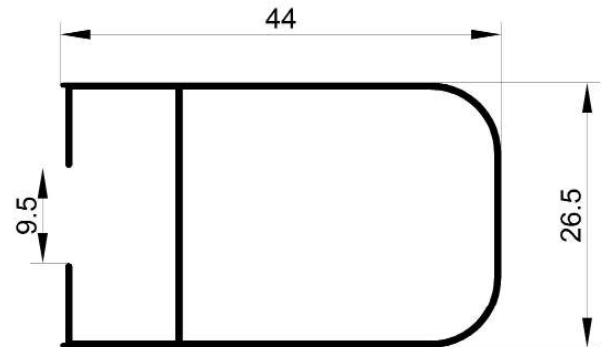

**20401**

Est Weight: 0.279 kg/m

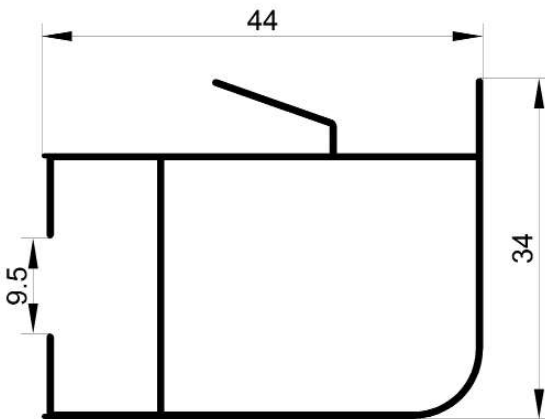

**20402**

Est Weight: 0.327 kg/m

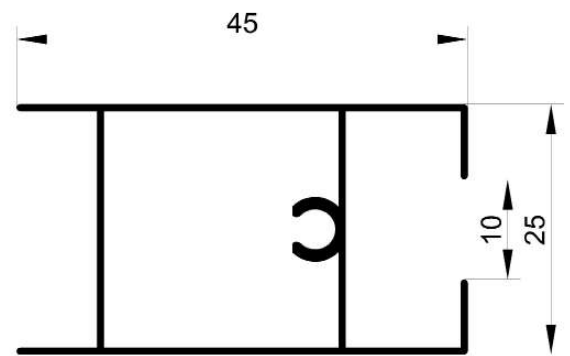

**20403**

Est Weight: 0.319 kg/m

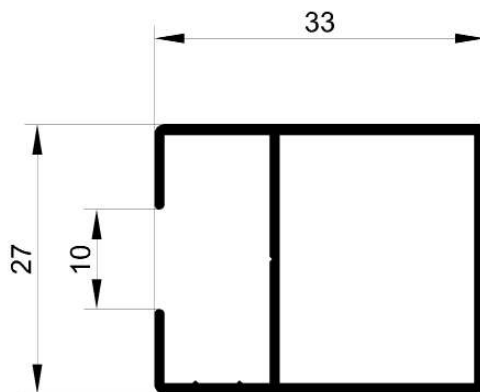

**20200**

Est Weight: 0.377 kg/m

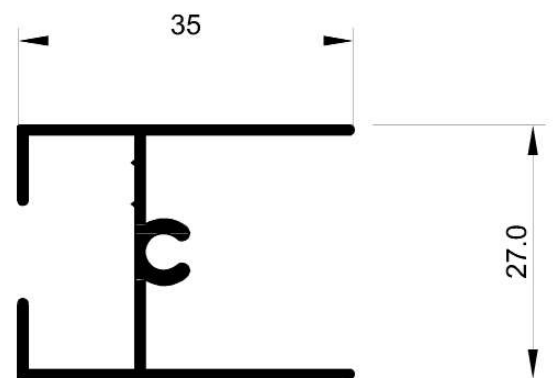

**10015**

Est Weight: 0.300 kg/m



سالكو

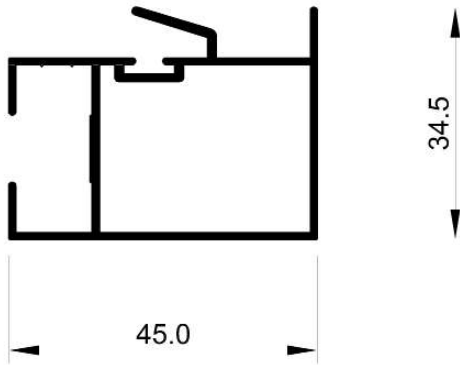

**20010**

Est Weight: 0.483 kg/m

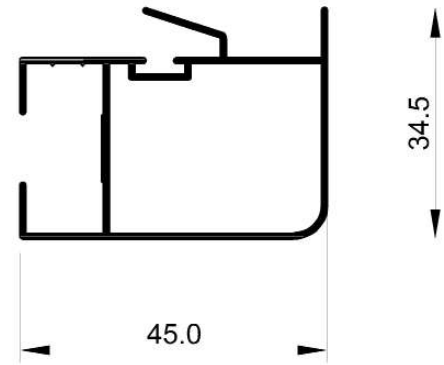

**20210**

Est Weight: 0.483 kg/m



**20009**

Est Weight: 0.408 kg/m

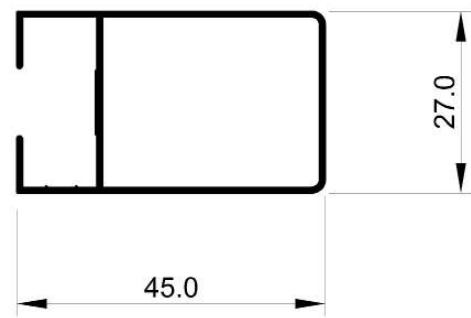

**20214**

Est Weight: 0.408 kg/m

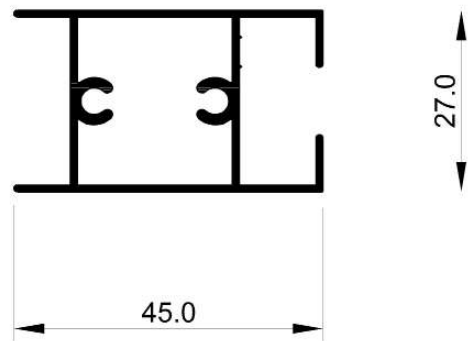

**20011**

Est Weight: 0.475 kg/m

# سحاب ضيق ومعدل Sliding 75-98 mm

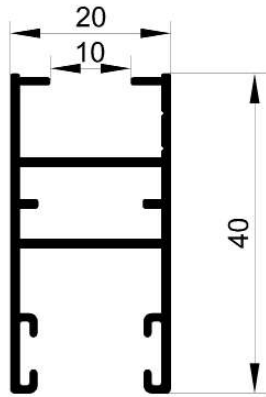

**20391**

Est Weight: 0.450 kg/m

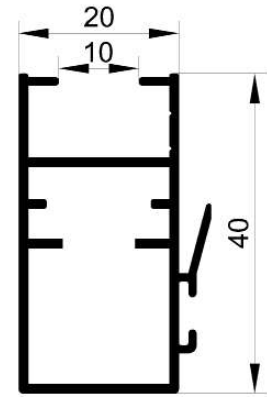

**20392**

Est Weight: 0.482 kg/m

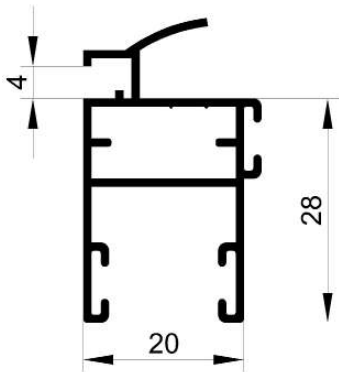

**20393**

Est Weight: 0.390 kg/m

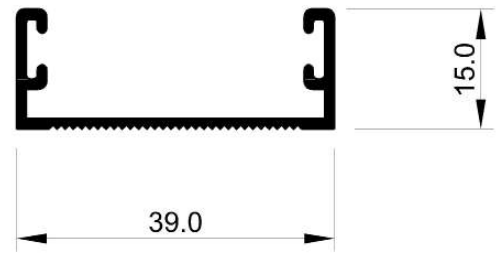

**10032**

Est Weight: 0.270 kg/m

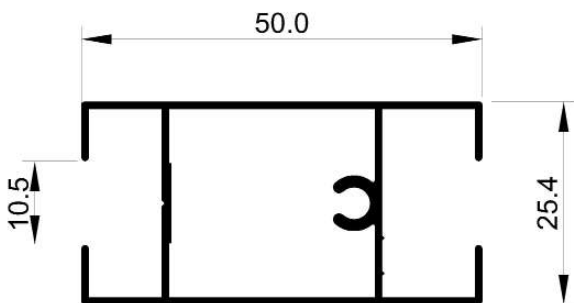

**20305**

Est Weight: 0.487 kg/m

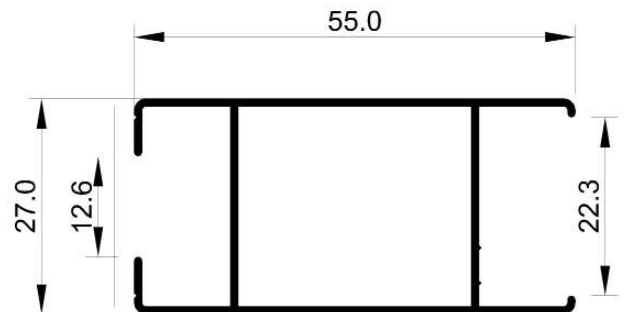

**20275**

Est Weight: 0.476 kg/m

سالكو



**20013**

Est Weight: 0.292 kg/m

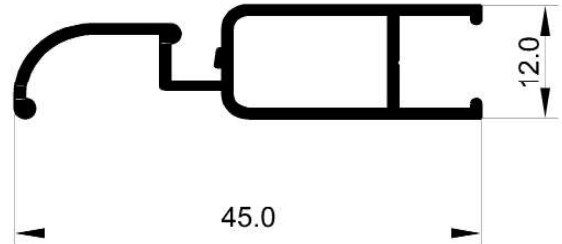

**20040**

Est Weight: 0.340 kg/m

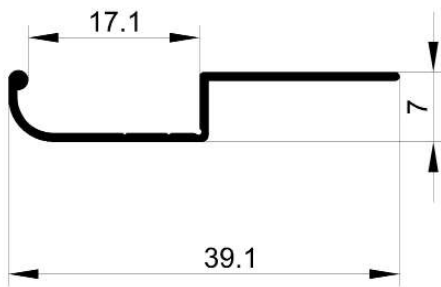

**10324**

Est Weight: 0.124 kg/m

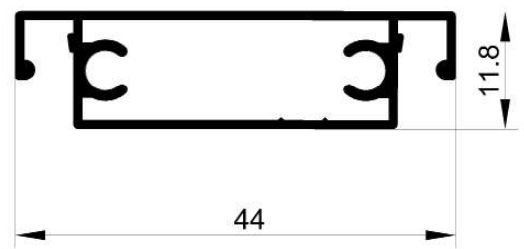

**20354**

Est Weight: 0.344 kg/m

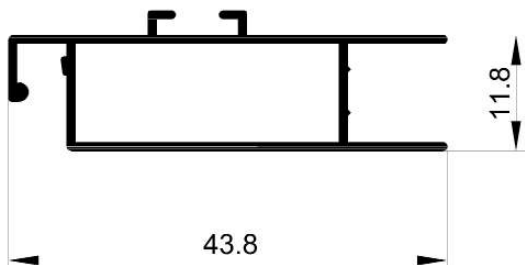

**20226**

Est Weight: 0.292 kg/m

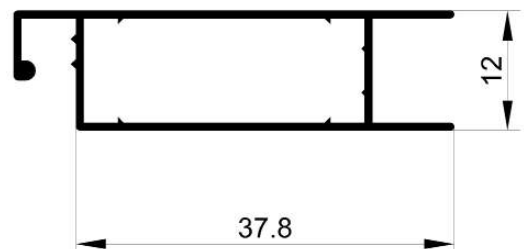

**20313**

Est Weight: 0.238 kg/m

# سحاب ضيق ومعدل Sliding 75-98 mm

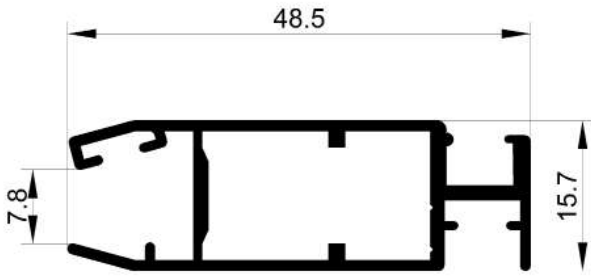

**20395**

**Est Weight: 0.450 kg/m**

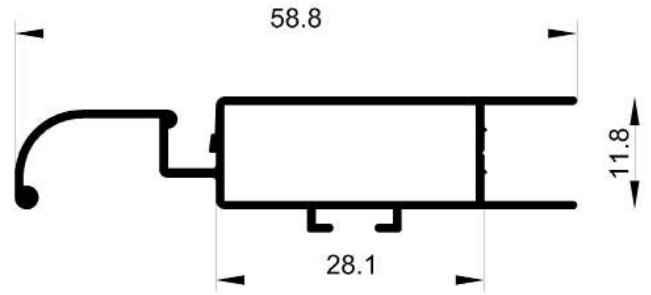

**20340**

**Est Weight: 0.350 kg/m**

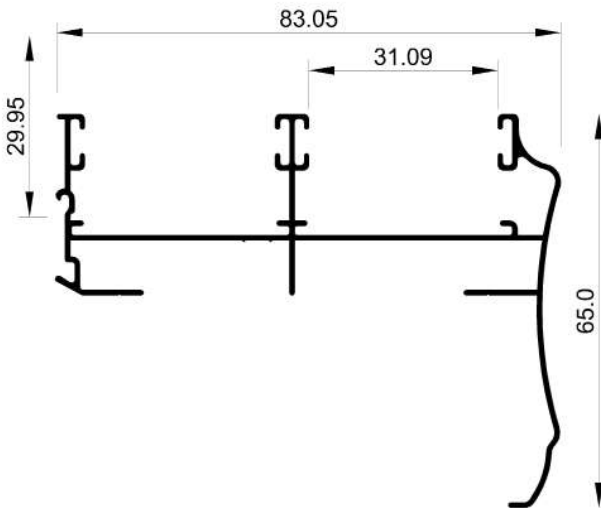

**10287**

**Est Weight: 0.730 kg/m**

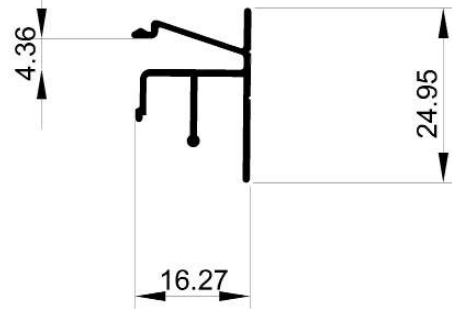

**10288**

**Est Weight: 0.210 kg/m**

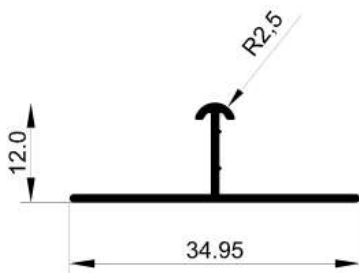

**10289**

**Est Weight: 0.150 kg/m**

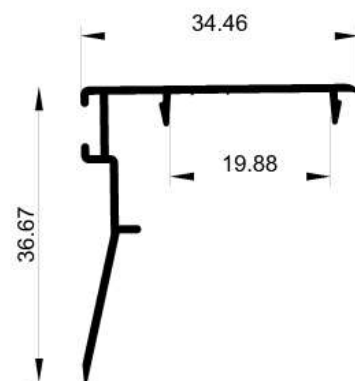

**10290**

**Est Weight: 0.240 kg/m**

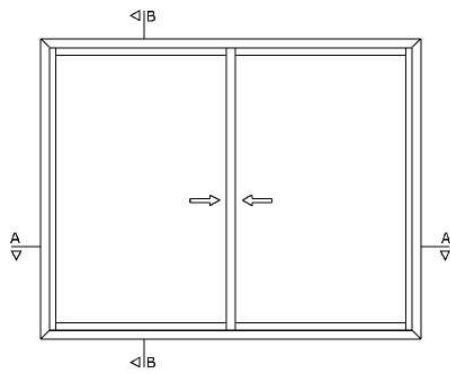
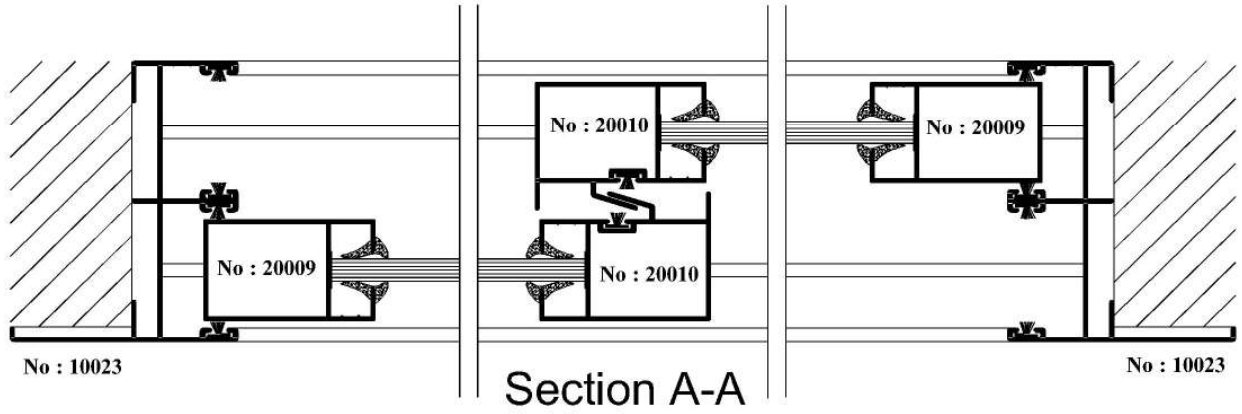

نموذج نافذة سحاب ضيق

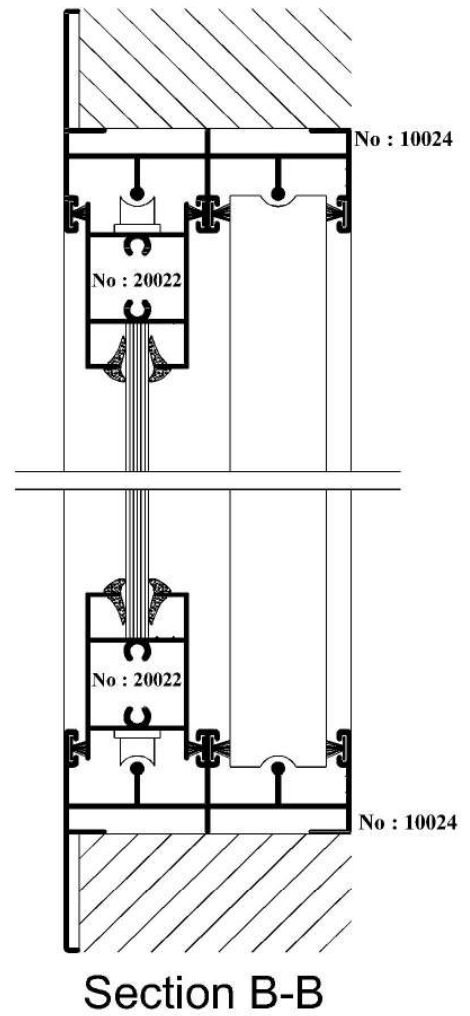

# سحاب ضيق ومعدل Sliding 75-98 mm

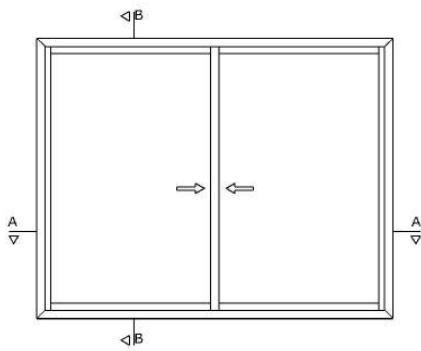
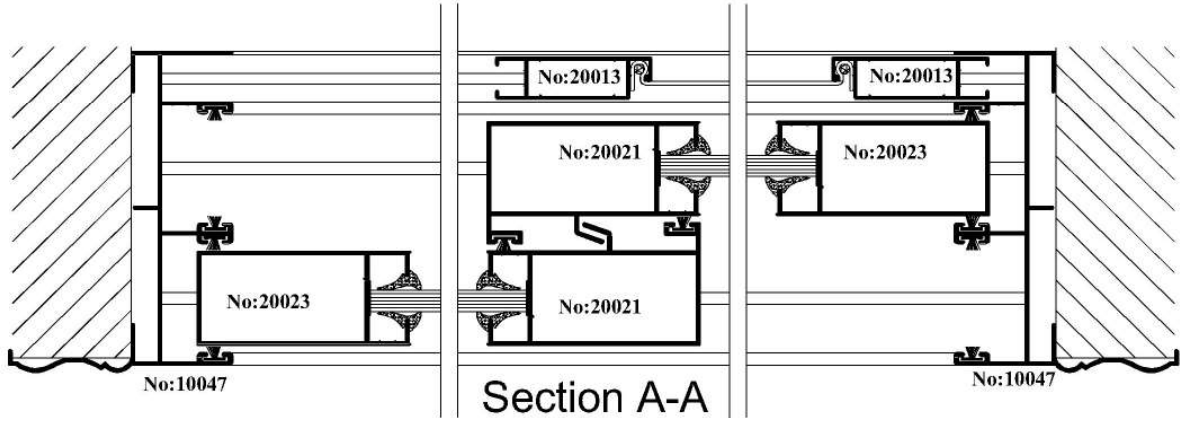

نموذج نافذة سحاب معدل

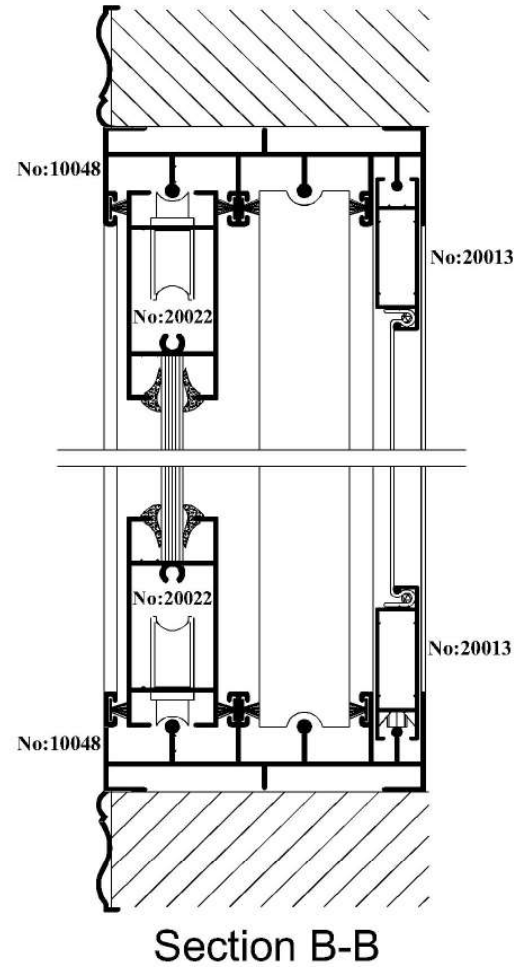

كوار

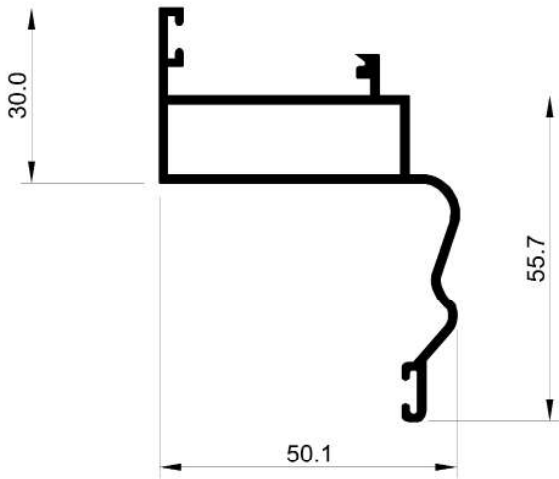

**20098**

**Est Weight: 0.757 kg/m**

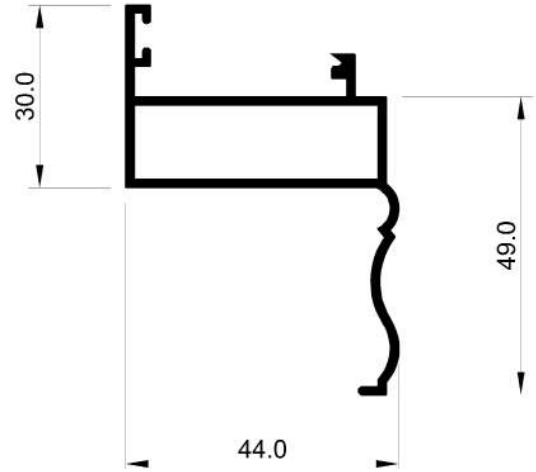

**20099**

**Est Weight: 0.713 kg/m**

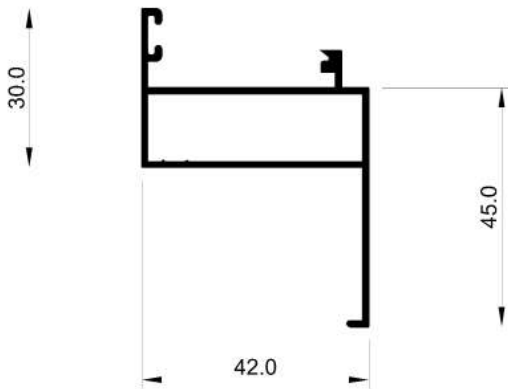

**20046**

**Est Weight: 0.572 kg/m**

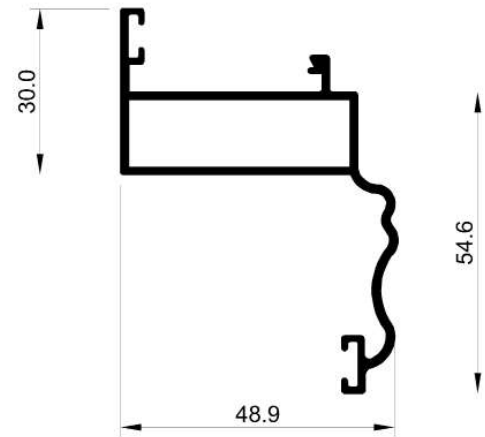

**20208**

**Est Weight: 0.783 kg/m**

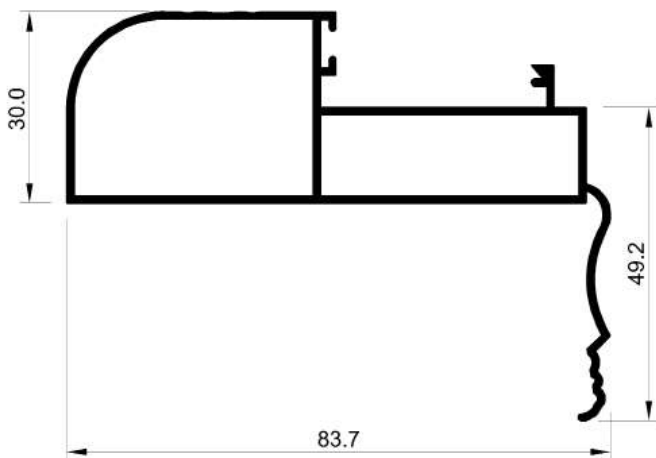

**20101**

**Est Weight: 0.933 kg/m**

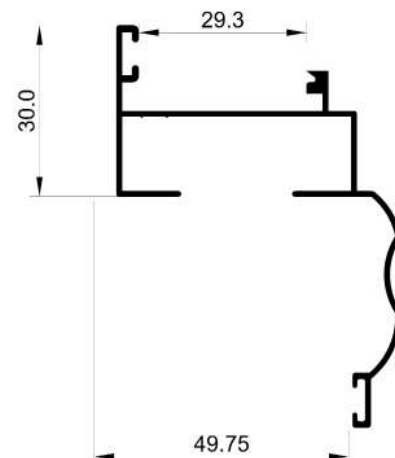

**10309**

**Est Weight: 0.482 kg/m**

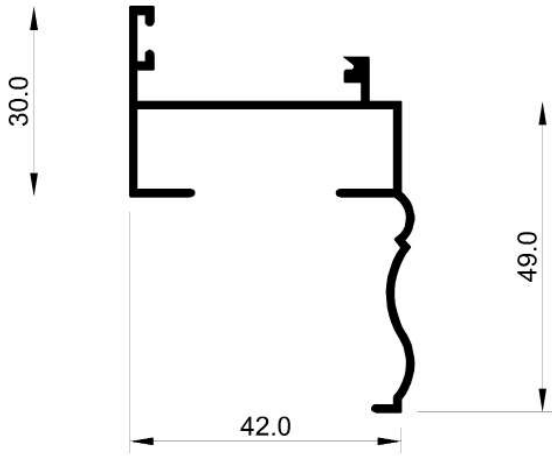

**10011**  
Est Weight: 0.433 kg/m

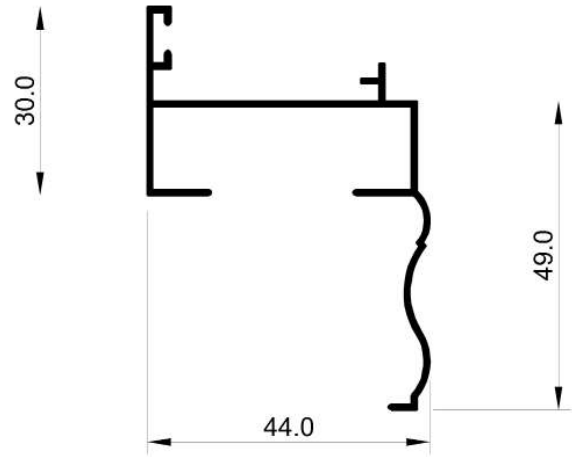

**10210**  
Est Weight: 0.388 kg/m

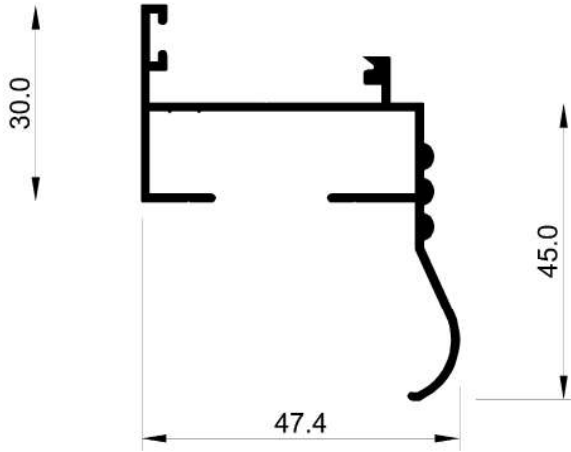

**10012**  
Est Weight: 0.530 kg/m

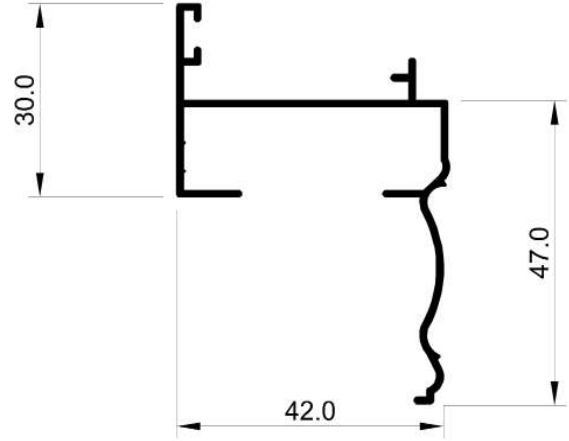

**10171**  
Est Weight: 0.420 kg/m

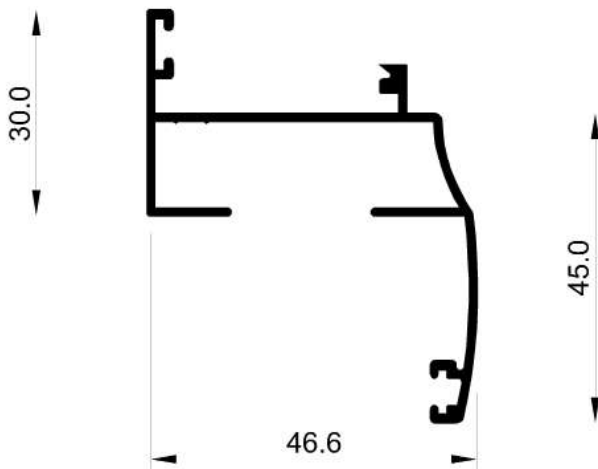

**10119**  
Est Weight: 0.467 kg/m

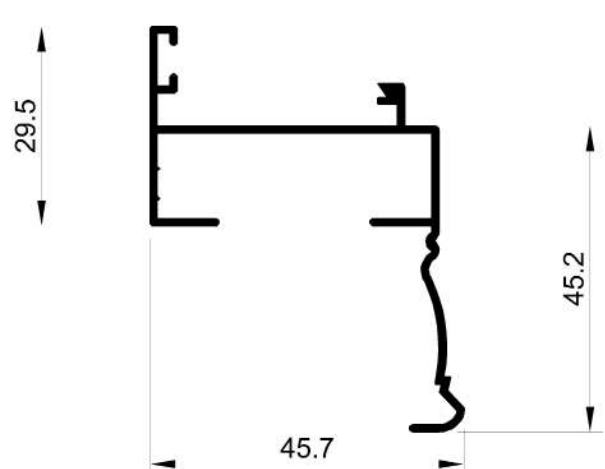

**10185**  
Est Weight: 0.440 kg/m



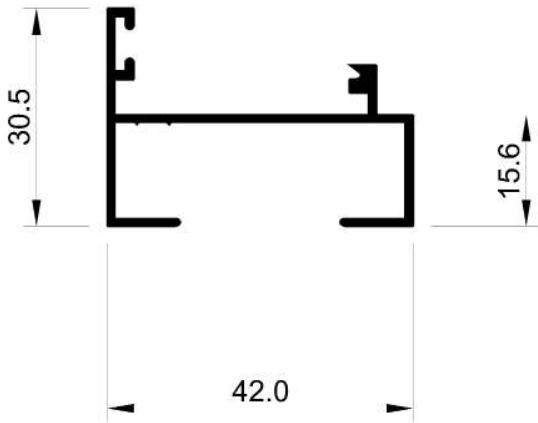

**10003**

**Est Weight: 0.350 kg/m**

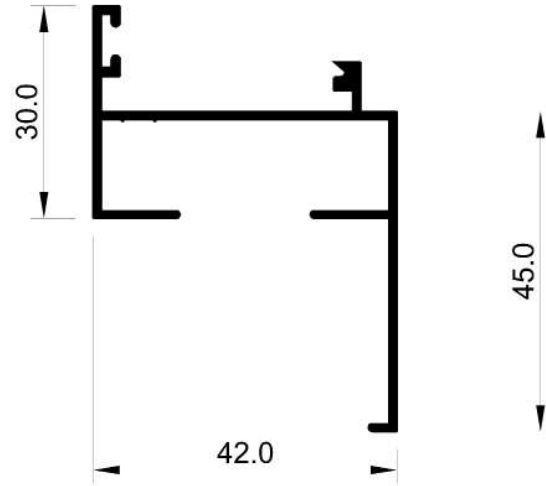

**10004**

**Est Weight: 0.450 kg/m**

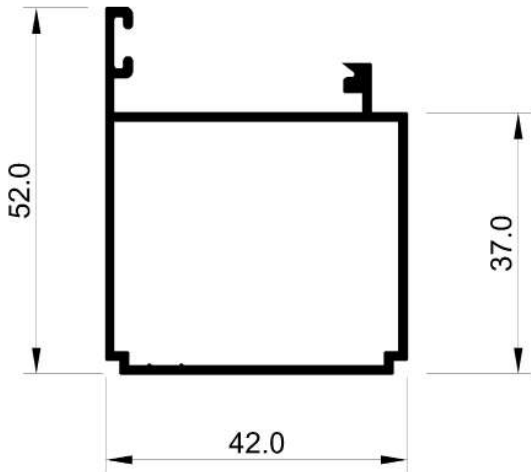

**20069**

**Est Weight: 0.560 kg/m**

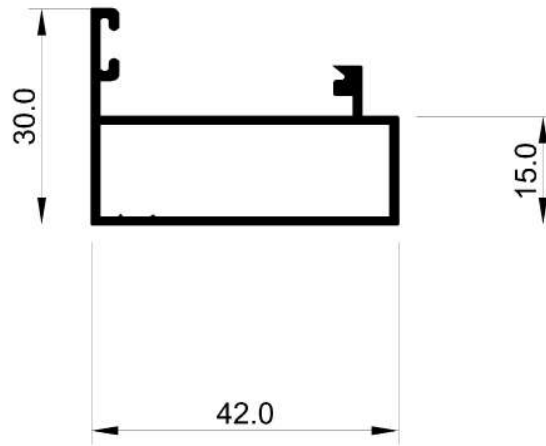

**20070**

**Est Weight: 0.564 kg/m**

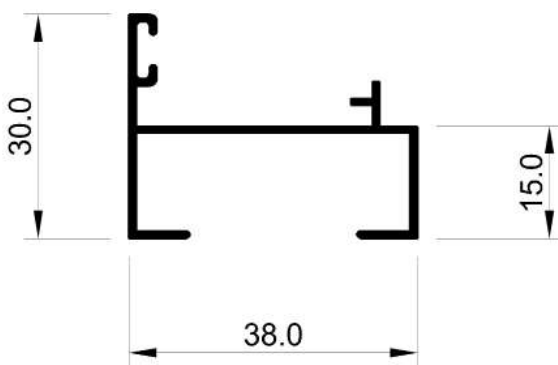

**10078**

**Est Weight: 0.302 kg/m**



**10132**

**Est Weight: 0.272 kg/m**

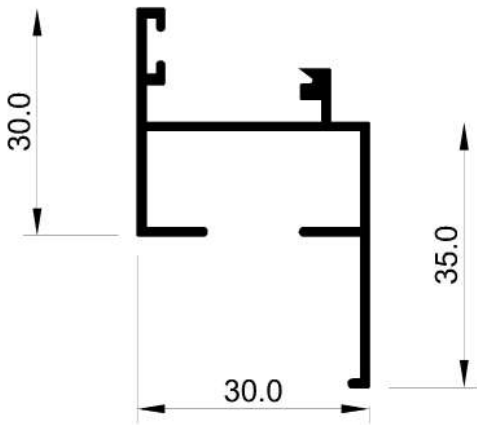

**10061**

Est Weight: 0.393 kg/m

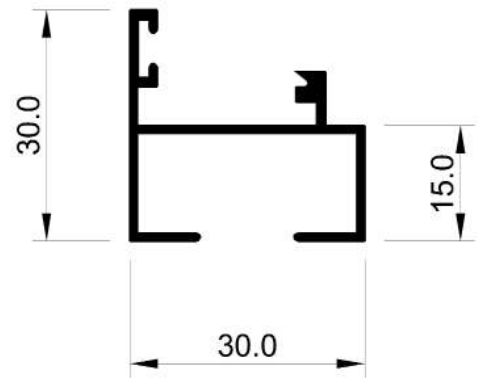

**10062**

Est Weight: 0.299 kg/m

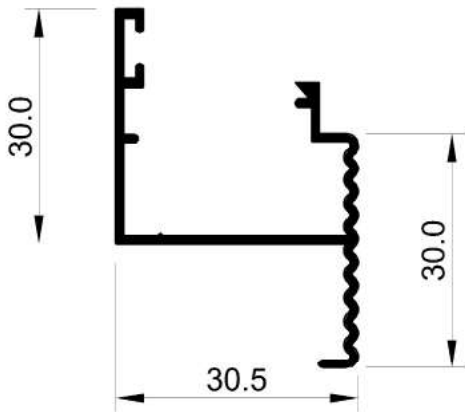

**10081**

Est Weight: 0.572 kg/m

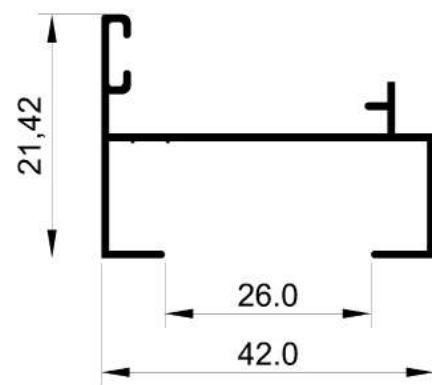

**10260**

Est Weight: 0.342 kg/m

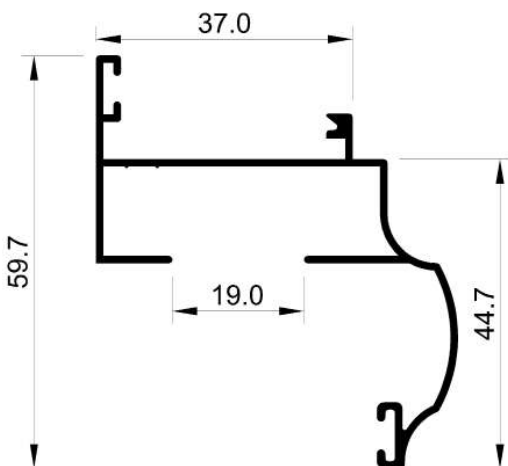

**10285**

Est Weight: 0.540 kg/m

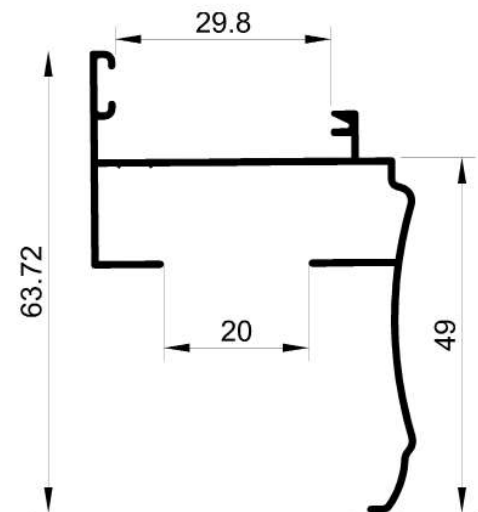

**10291**

Est Weight: 0.440 kg/m

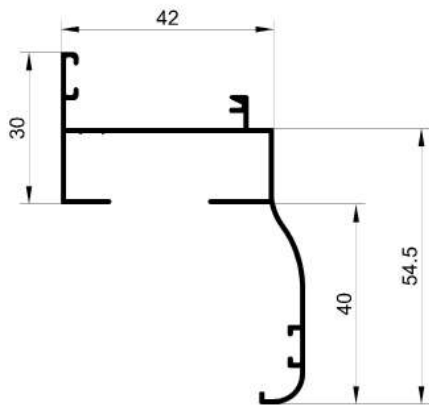

**10344**

**Est Weight: 0.490 kg/m**

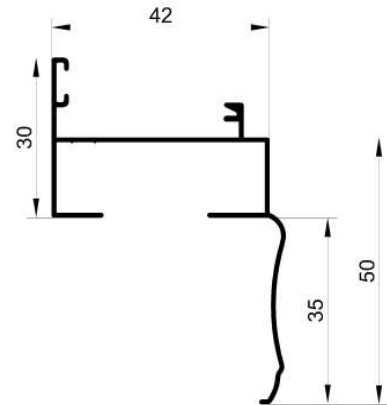

**10347**

**Est Weight: 0.400 kg/m**

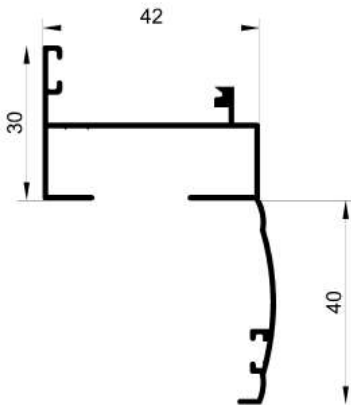

**10350**

**Est Weight: 0.523 kg/m**

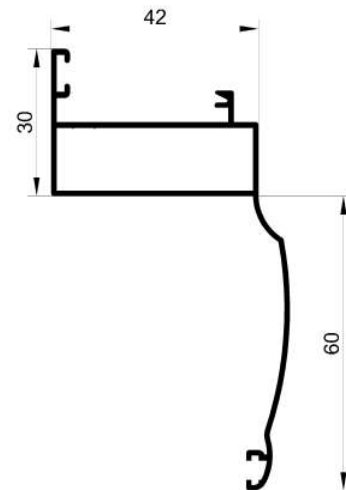

**20364**

**Est Weight: 0.647 kg/m**

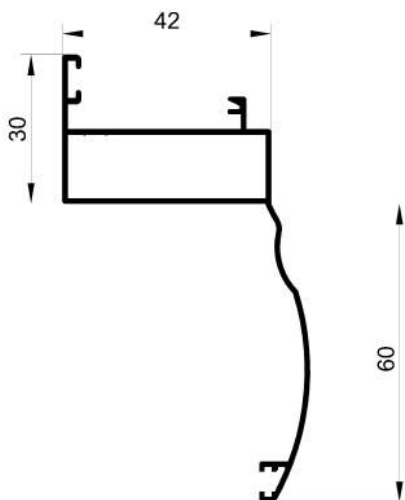

**20370**

**Est Weight: 0.661 kg/m**

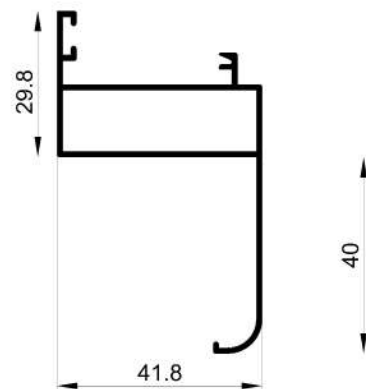

**20411**

**Est Weight: 0.620 kg/m**

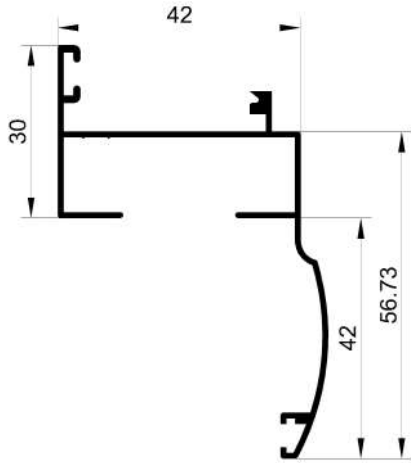

**10312**

**Est Weight: 0.506 kg/m**

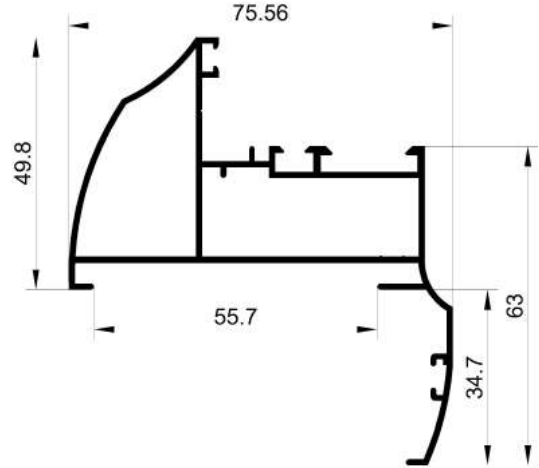

**20145**

**Est Weight: 1.080 kg/m**

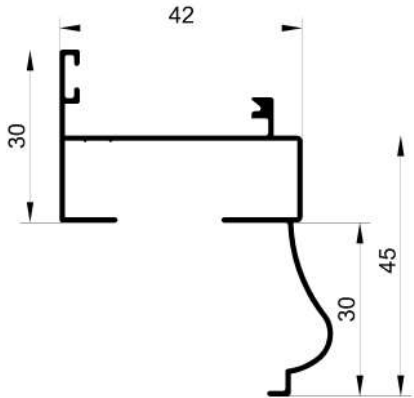

**10321**

**Est Weight: 0.414 kg/m**

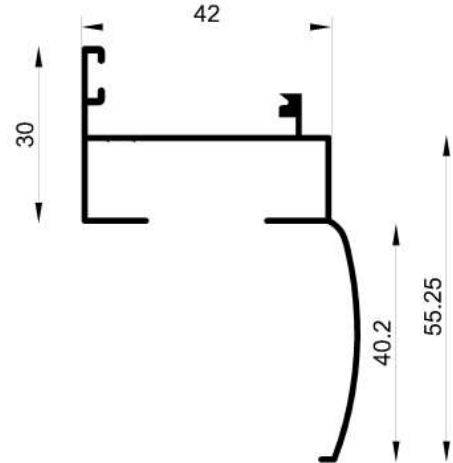

**10327**

**Est Weight: 0.477 kg/m**

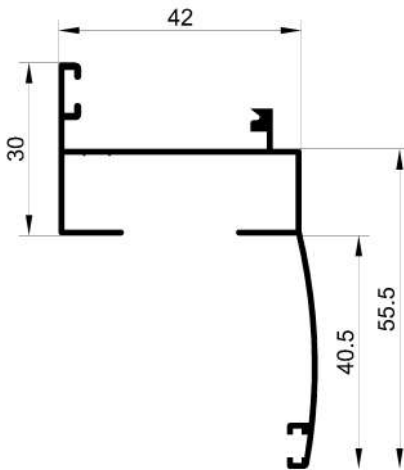

**10331**

**Est Weight: 0.498 kg/m**

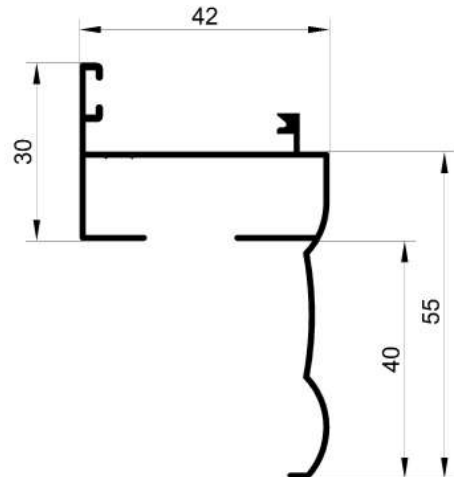

**10338**

**Est Weight: 0.482 kg/m**

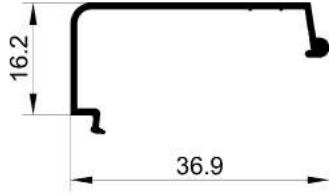

**10374**

**Est Weight: 0.172 kg/m**

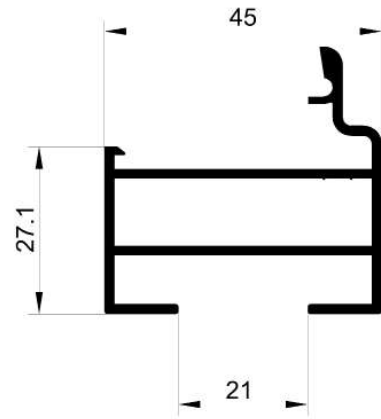

**20372**

**Est Weight: 0.815 kg/m**

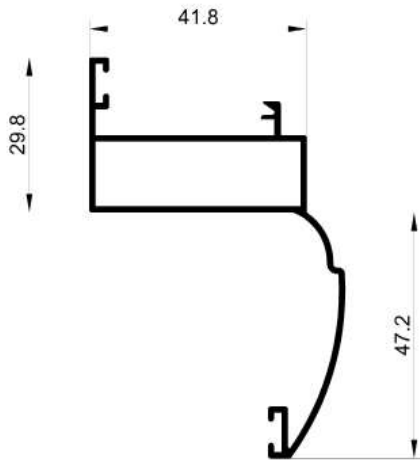

**20416**

**Est Weight: 0.693 kg/m**

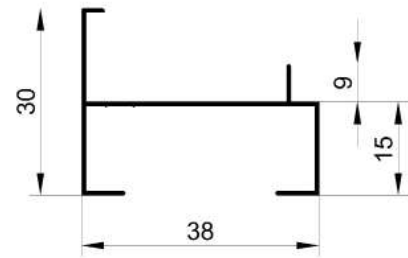

**10394**

**Est Weight: 0.195 kg/m**

# زد عريض وضيق Hinged Shutters

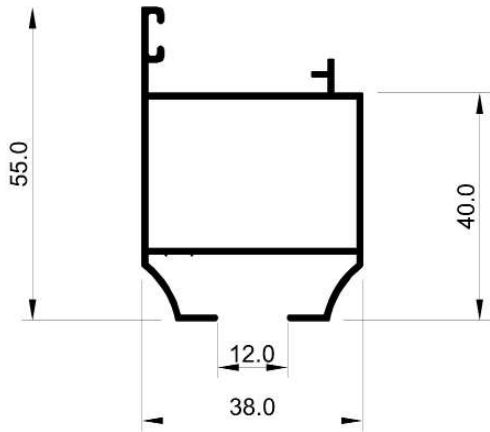

**20095**

**Est Weight: 0.540 kg/m**

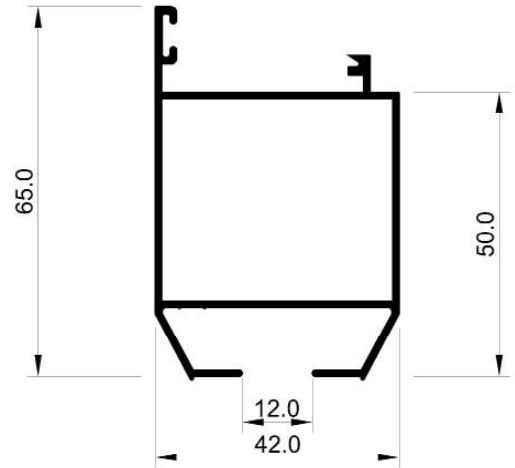

**20025**

**Est Weight: 0.731 kg/m**

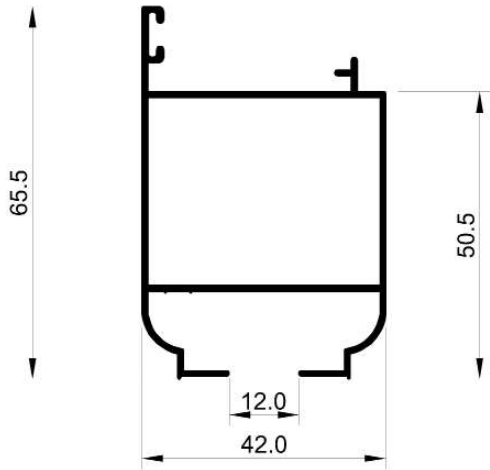

**20169**

**Est Weight: 0.633 kg/m**

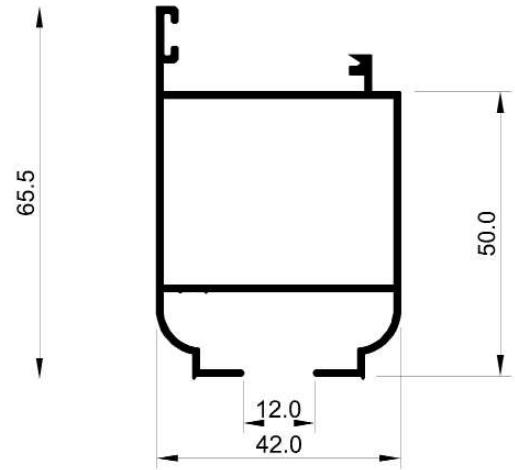

**20088**

**Est Weight: 0.944 kg/m**

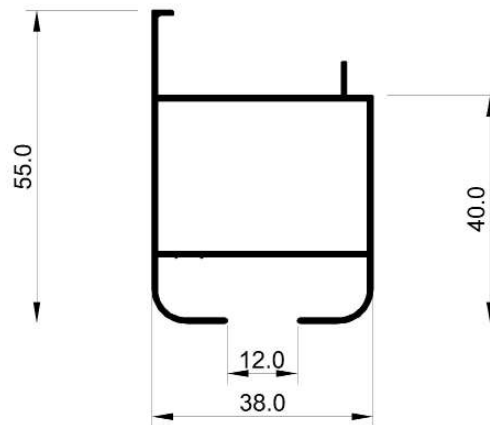

**20131**

**Est Weight: 0.503 kg/m**

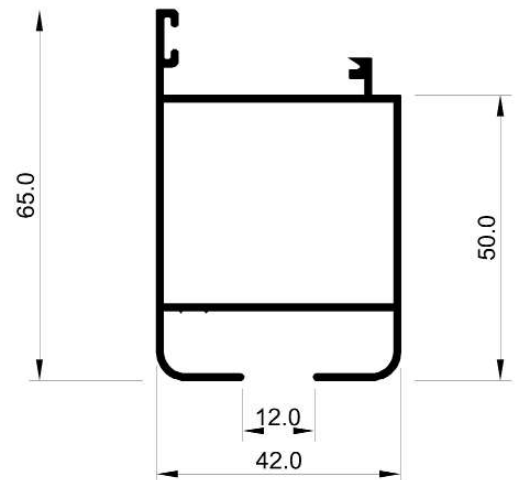

**20026**

**Est Weight: 0.742 kg/m**

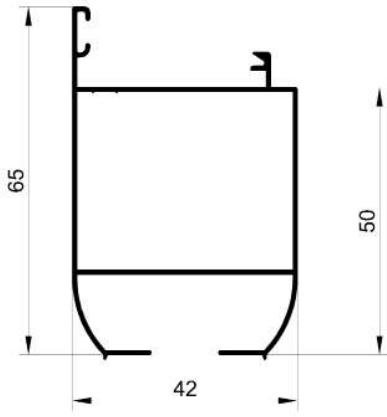

**20330**

**Est Weight: 0.580 kg/m**

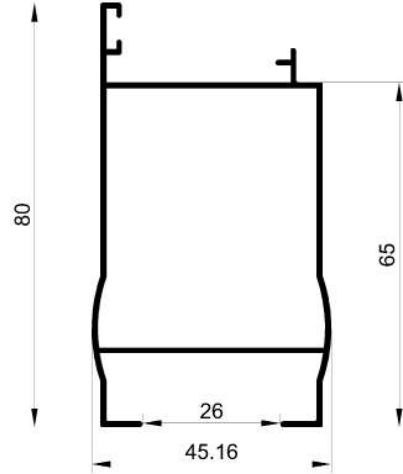

**20346**

**Est Weight: 0.826 kg/m**

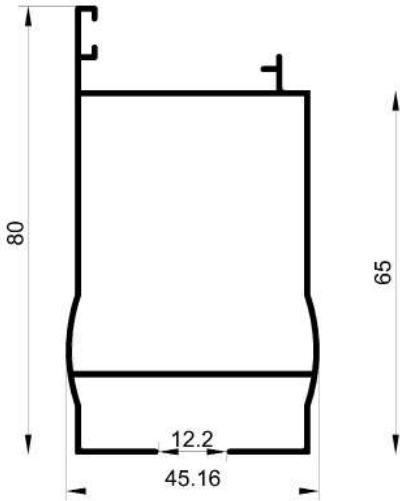

**20342**

**Est Weight: 0.777 kg/m**

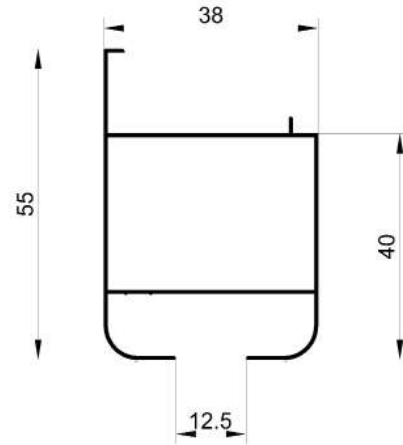

**20404**

**Est Weight: 0.368 kg/m**

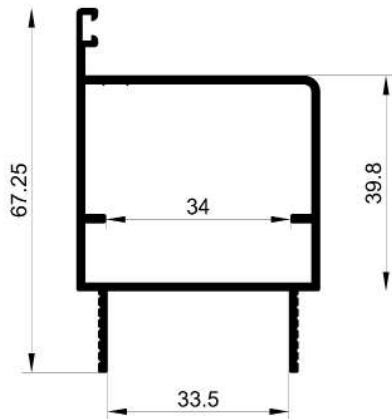

**20371**

**Est Weight: 0.972 kg/m**

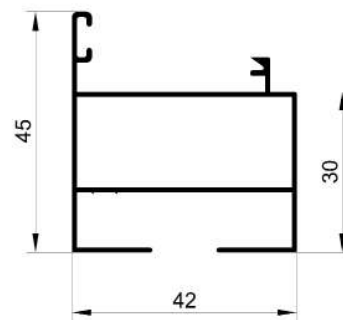

**20024**

**Est Weight: 0.503 kg/m**

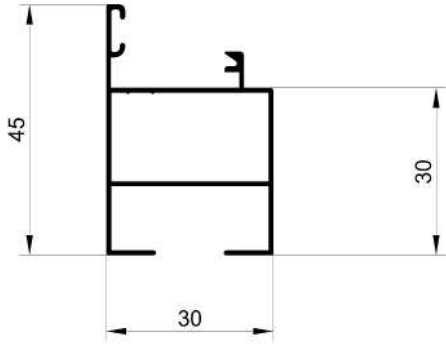

**20016**

**Est Weight: 0.384 kg/m**

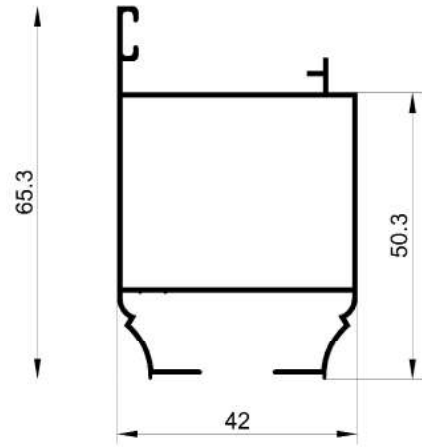

**20147**

**Est Weight: 0.574 kg/m**

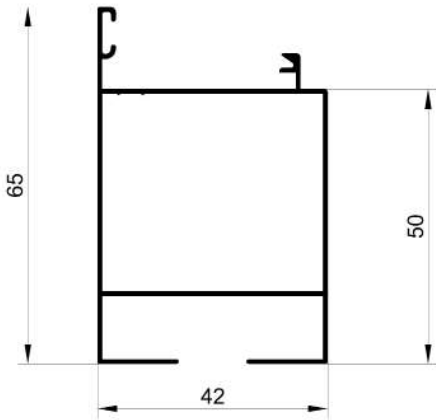

**20008**

**Est Weight: 0.561 kg/m**

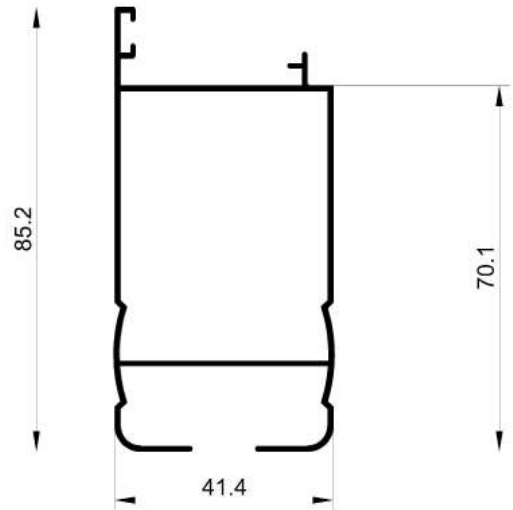

**20209**

**Est Weight: 0.900 kg/m**

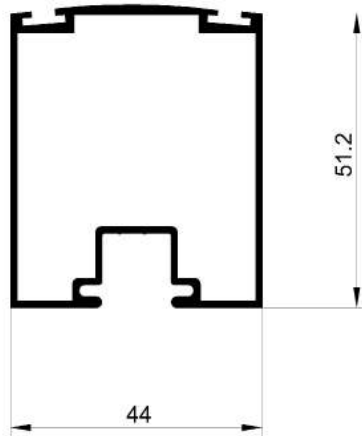

**20019**

**Est Weight: 0.826 kg/m**



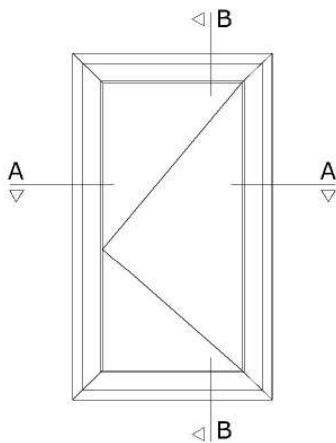
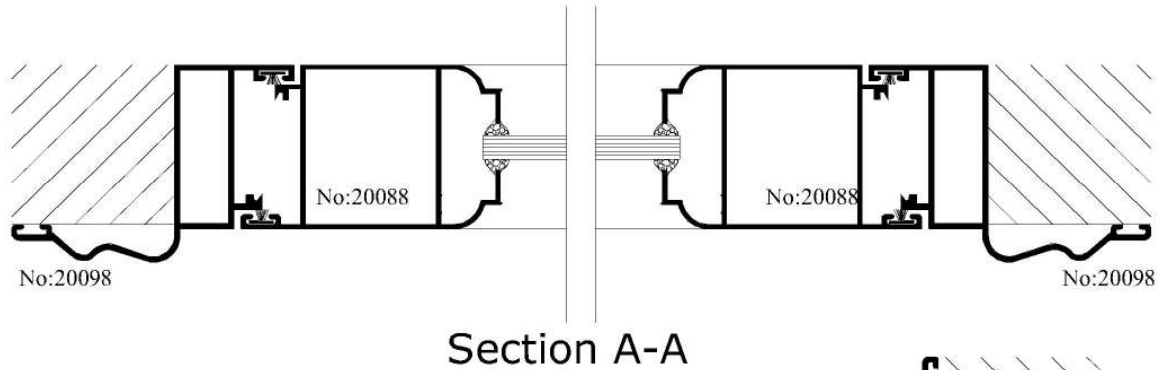

مفصلات فتحة نافذة

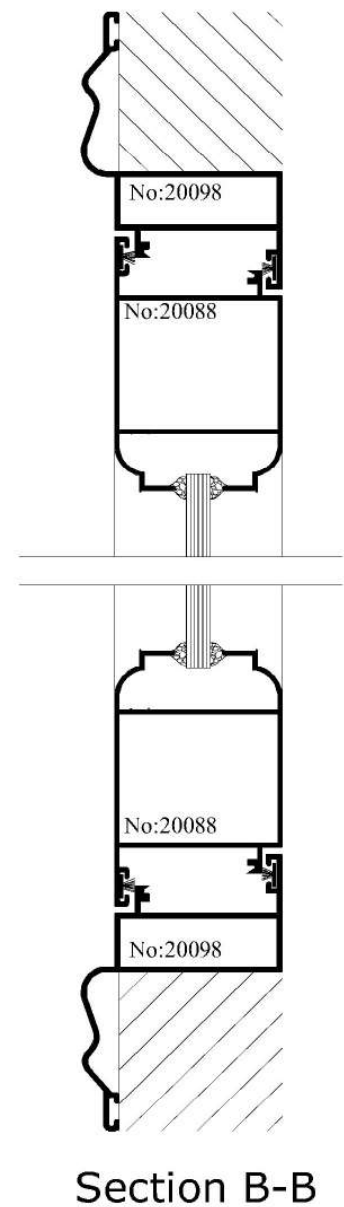

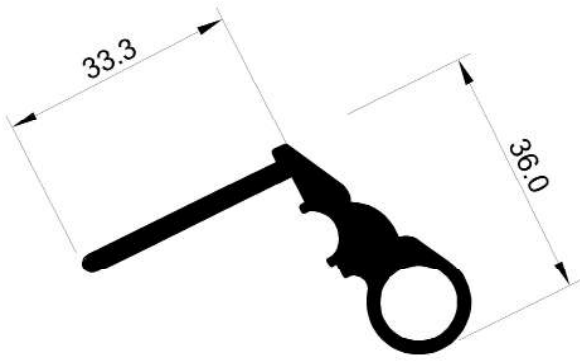

**20127**

Est Weight: 0.789 kg/m



**20018**

Est Weight: 0.883 kg/m

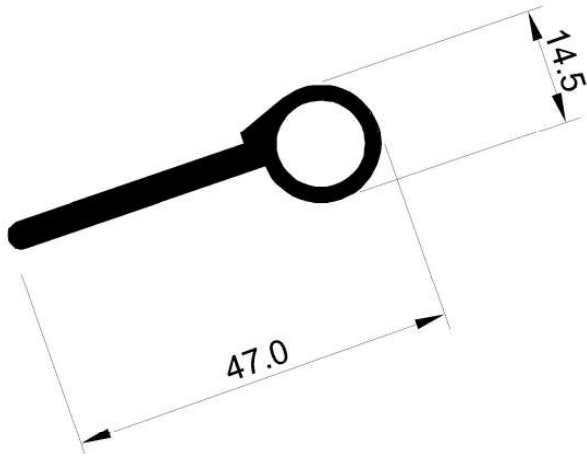

**20017**

Est Weight: 0.494 kg/m

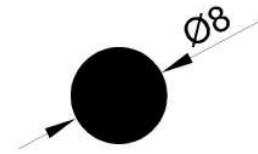

**10274**

Est Weight: 0.136 kg/m

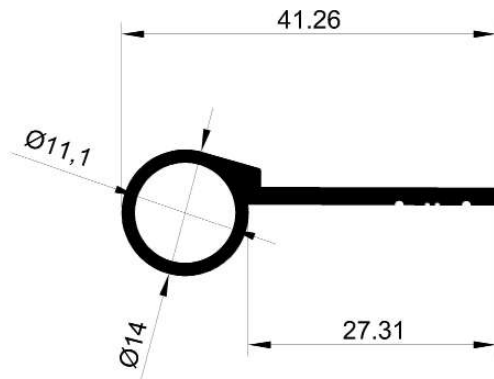

**20128**

Est Weight: 0.317 kg/m

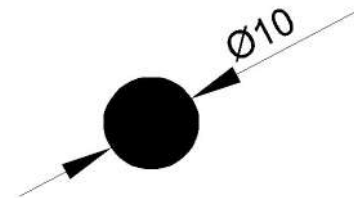

**10113**

Est Weight: 0.212 kg/m

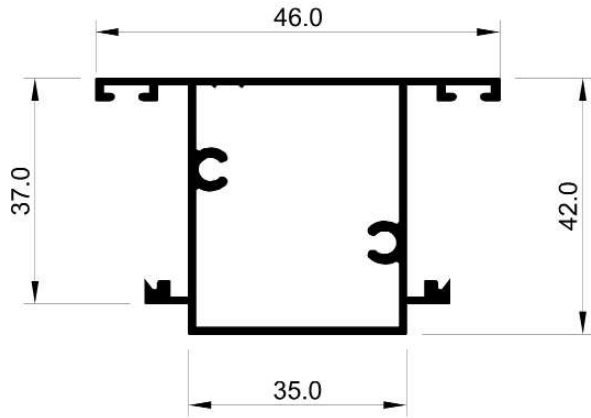

**20033**

**Est Weight: 0.800 kg/m**

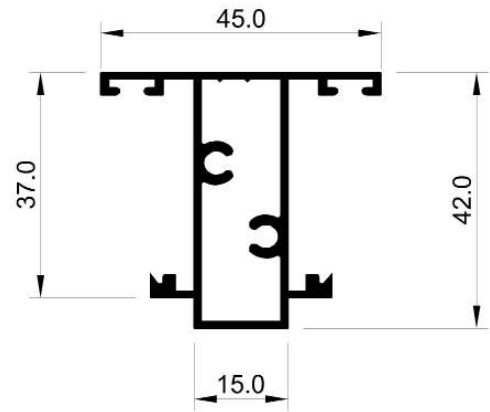

**20032**

**Est Weight: 0.667 kg/m**



**10002**

**Est Weight: 0.218 kg/m**

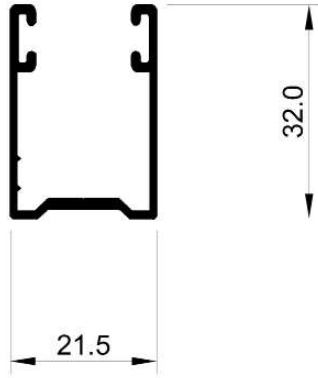

**10028**  
Est Weight: 0.280 kg/m

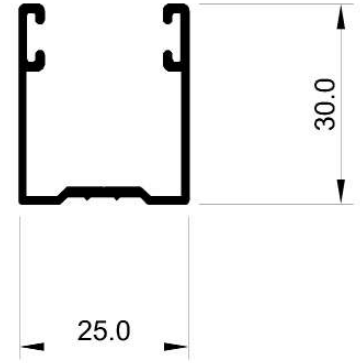

**10033**  
Est Weight: 0.289 kg/m

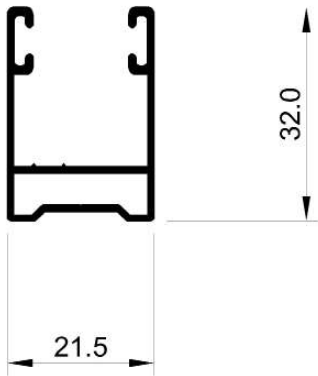

**20093**  
Est Weight: 0.313 kg/m

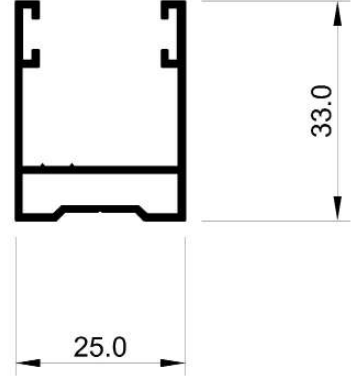

**20012**  
Est Weight: 0.328 kg/m

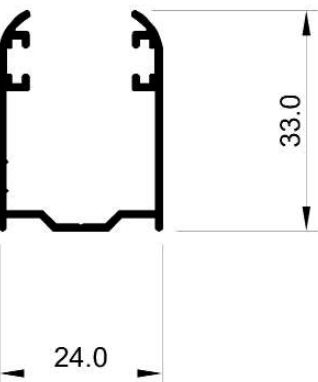

**10044**  
Est Weight: 0.313 kg/m

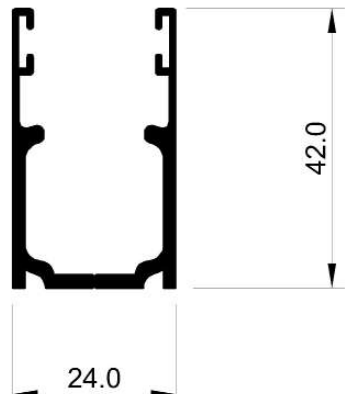

**10176**  
Est Weight: 0.544 kg/m

سالكو

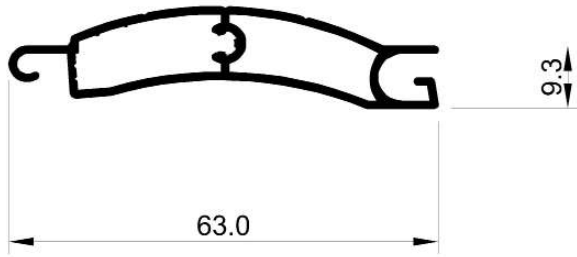

**20118**

**Est Weight: 0.464 kg/m**

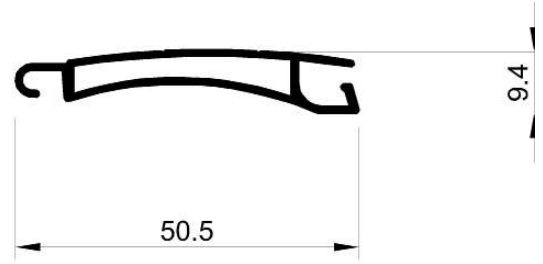

**20043**

**Est Weight: 0.318 kg/m**

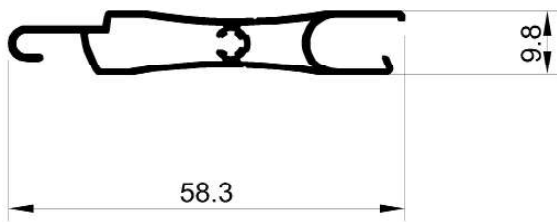

**20190**

**Est Weight: 0.350 kg/m**

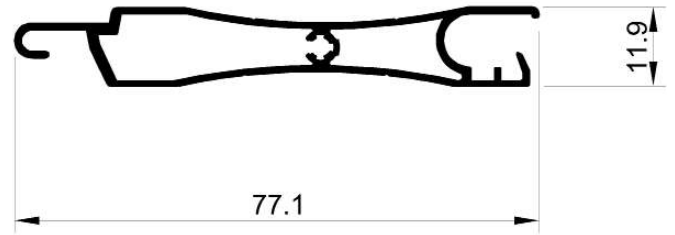

**20191**

**Est Weight: 0.583 kg/m**

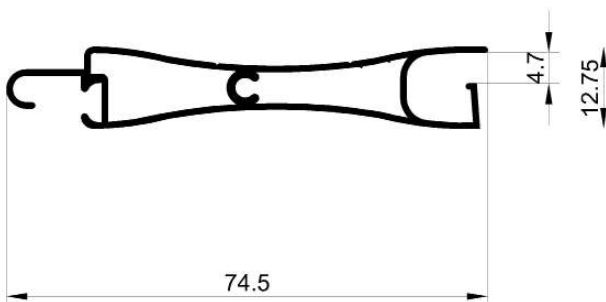

**20129**

**Est Weight: 0.520 kg/m**

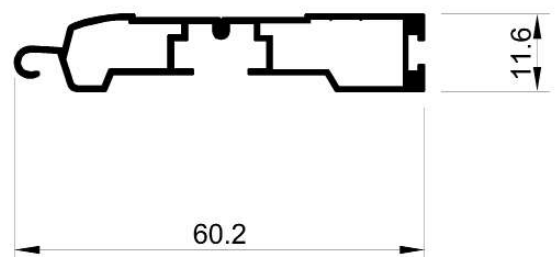

**20217**

**Est Weight: 0.410 kg/m**

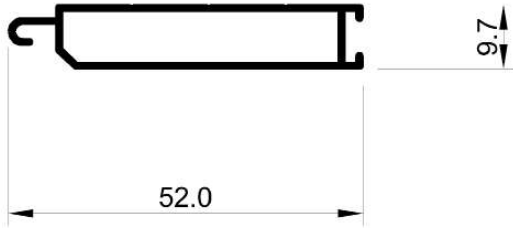

**20041**  
Est Weight: 0.332 kg/m

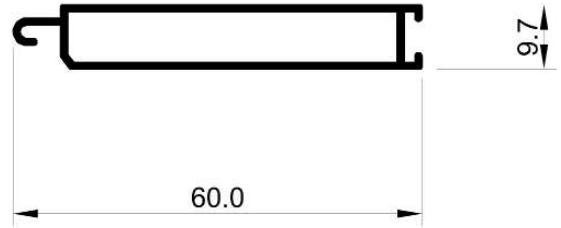

**20087**  
Est Weight: 0.380 kg/m

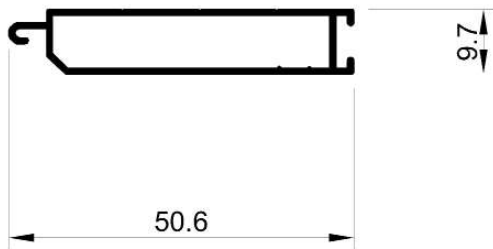

**20192**  
Est Weight: 0.332 kg/m

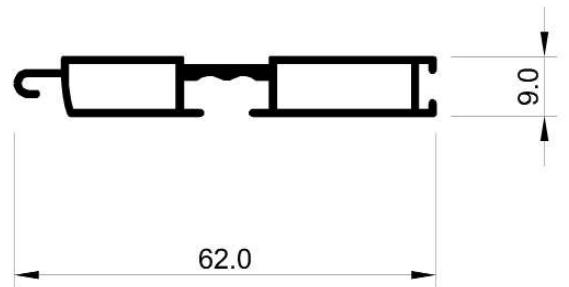

**20042**  
Est Weight: 0.418 kg/m

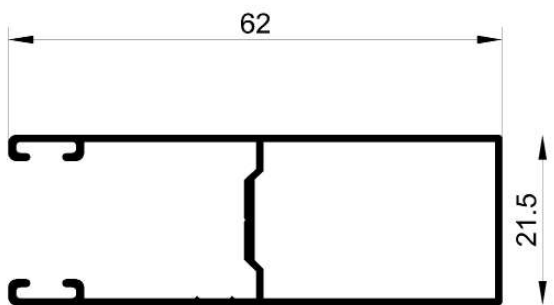

**20398**  
Est Weight: 0.452 kg/m

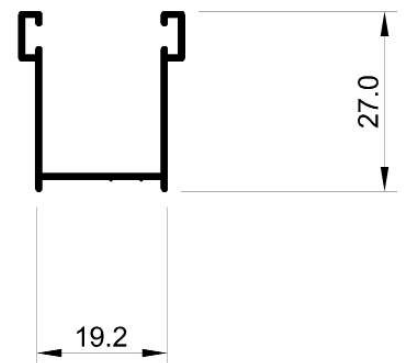

**10181**  
Est Weight: 0.199 kg/m

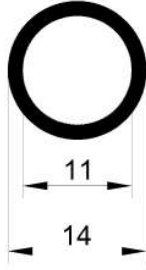

**20359**

**Est Weight: 0.160 kg/m**

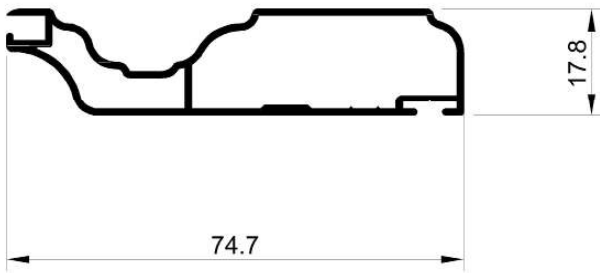

**20183**

**Est Weight: 0.707 kg/m**

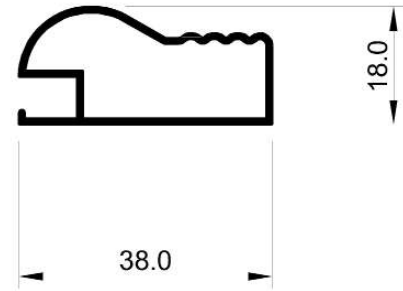

**20035**

**Est Weight: 0.300 kg/m**

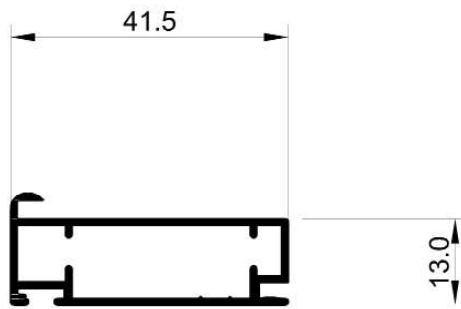

**20195**

**Est Weight: 0.346 kg/m**

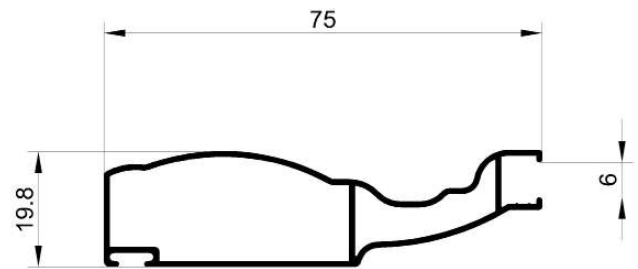

**20343**

**Est Weight: 0.525 kg/m**

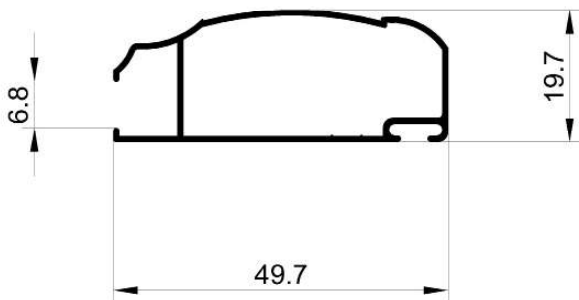

**20329**

**Est Weight: 0.342 kg/m**

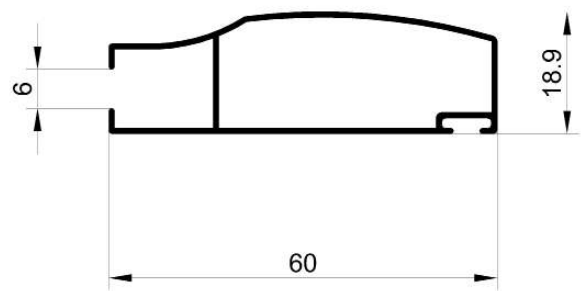

**20353**

**Est Weight: 0.392 kg/m**



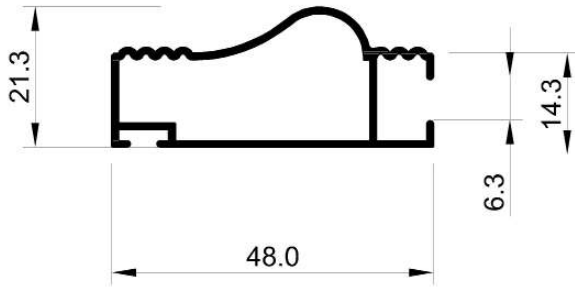

**20034**

**Est Weight: 0.342 kg/m**

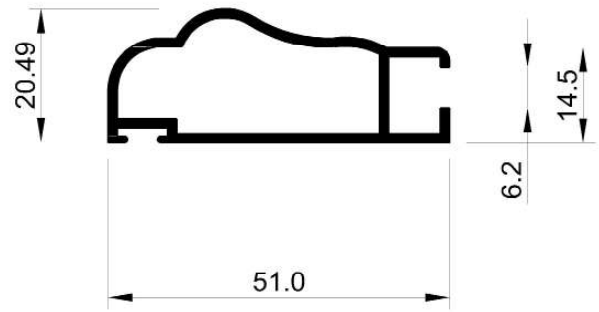

**20097**

**Est Weight: 0.500 kg/m**

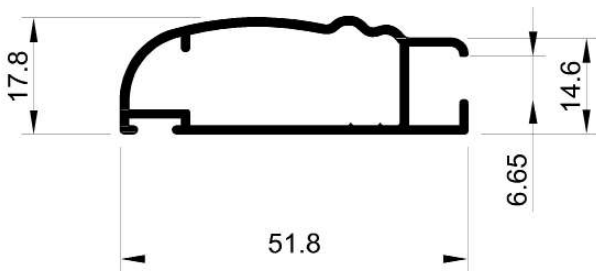

**20221**

**Est Weight: 0.459 kg/m**

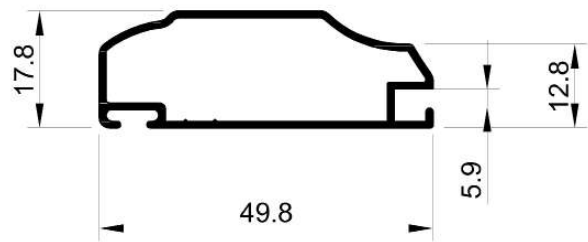

**20196**

**Est Weight: 0.366 kg/m**

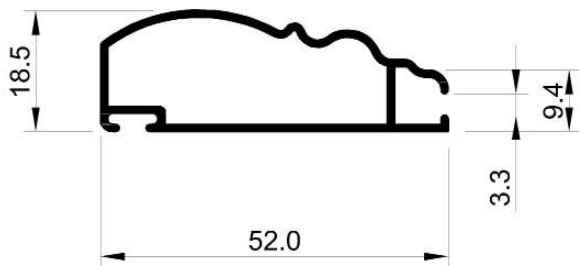

**20137**

**Est Weight: 0.400 kg/m**

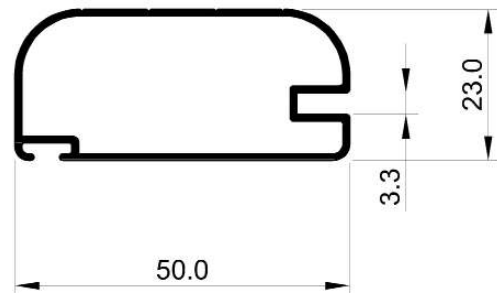

**20091**

**Est Weight: 0.382 kg/m**

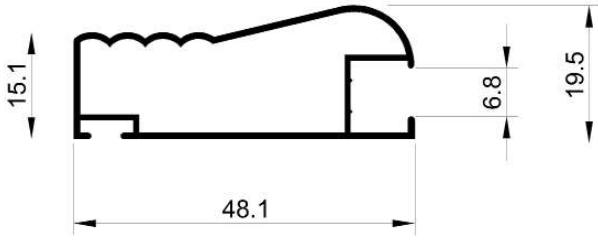

**20229**  
Est Weight: 0.400 kg/m

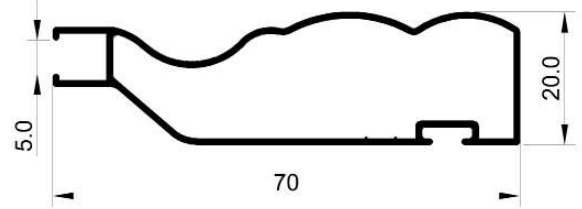

**20251**  
Est Weight: 0.491 kg/m



**20263**  
Est Weight: 0.400 kg/m

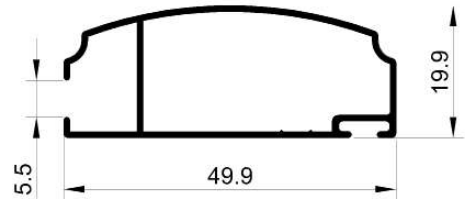

**20276**  
Est Weight: 0.376 kg/m

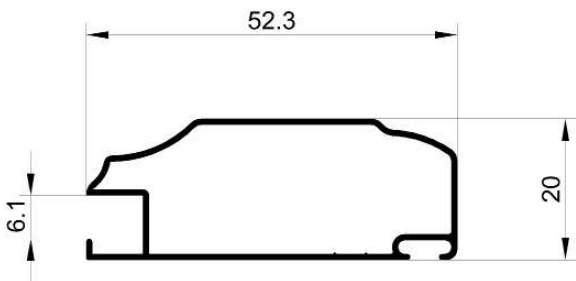

**20306**  
Est Weight: 0.340 kg/m

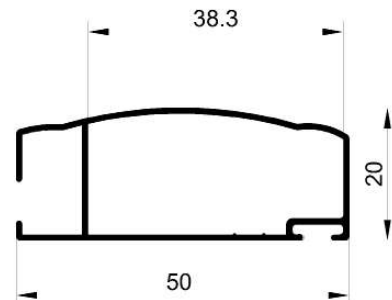

**20333**  
Est Weight: 0.357 kg/m

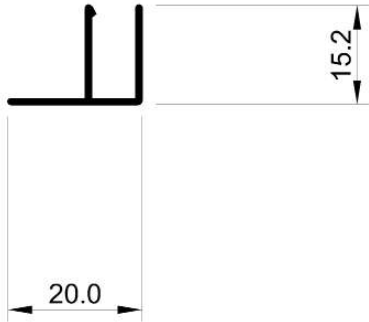

**10211**

**Est Weight: 0.124 kg/m**

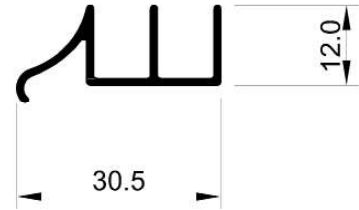

**10025**

**Est Weight: 0.198 kg/m**

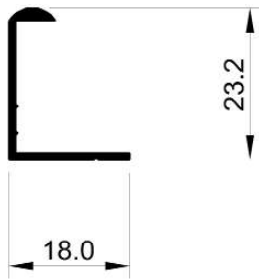

**10001**

**Est Weight: 0.131 kg/m**

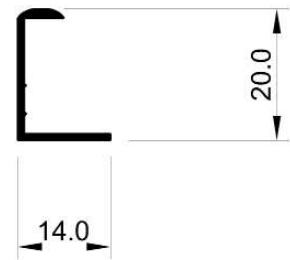

**10068**

**Est Weight: 0.108 kg/m**

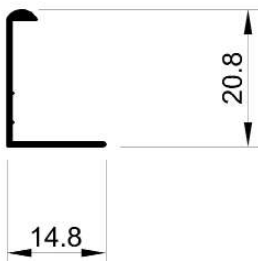

**10215**

**Est Weight: 0.096 kg/m**

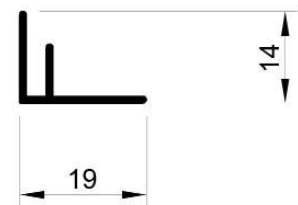

**10151**

**Est Weight: 0.107 kg/m**

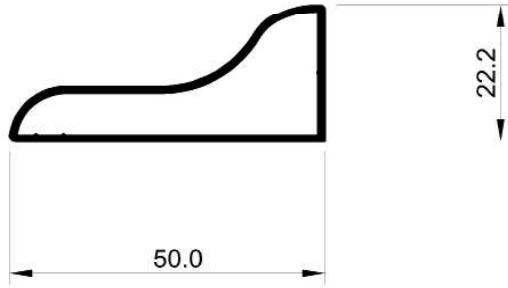

**20203**

**Est Weight: 0.400 kg/m**

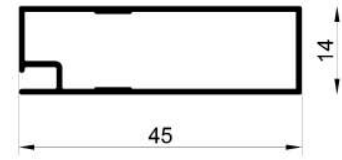

**20327**

**Est Weight: 0.303 kg/m**

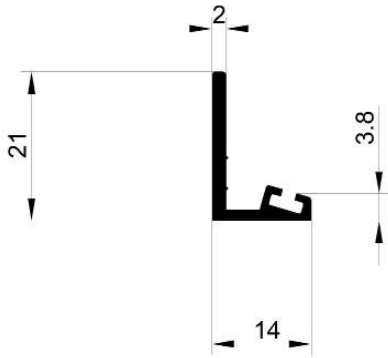

**10139**

**Est Weight: 0.185 kg/m**

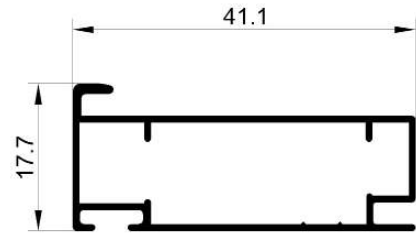

**20394**

**Est Weight: 0.289 kg/m**

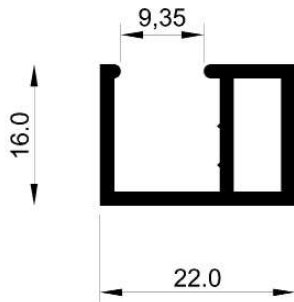

**20254**

**Est Weight: 0.315 kg/m**



**20092**

**Est Weight: 0.260 kg/m**

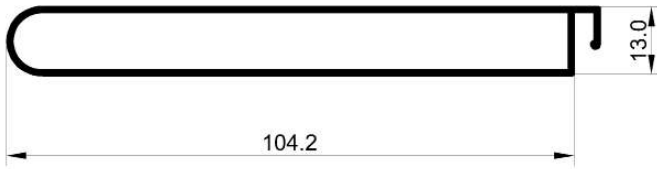

**20150**

Est Weight: 0.736 kg/m

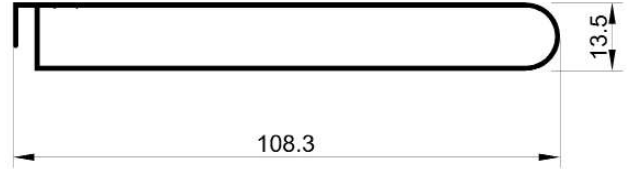

**20253**

Est Weight: 0.750 kg/m

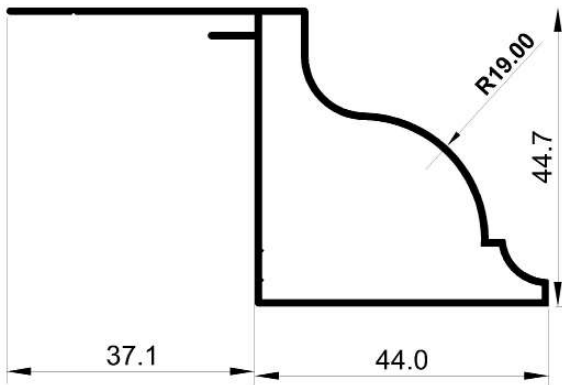

**20273**

Est Weight: 0.601 kg/m

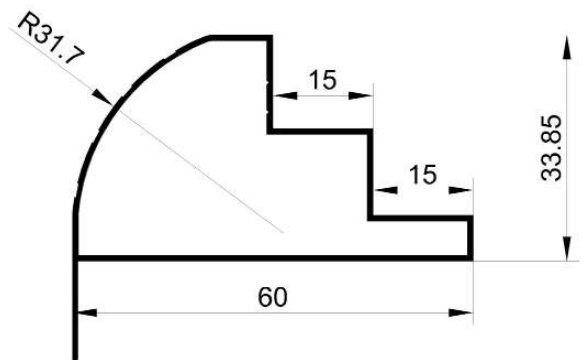

**20384**

Est Weight: 0.450 kg/m

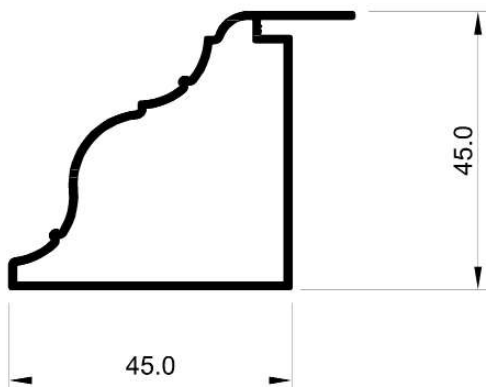

**20151**

Est Weight: 0.568 kg/m

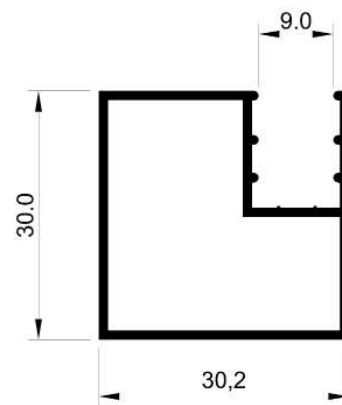

**20257**

Est Weight: 0.401 kg/m

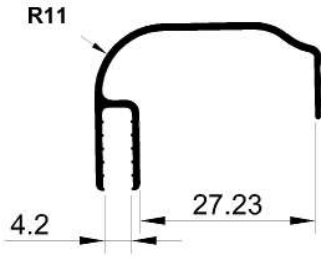

**10261**  
Est Weight: 0.260 kg/m

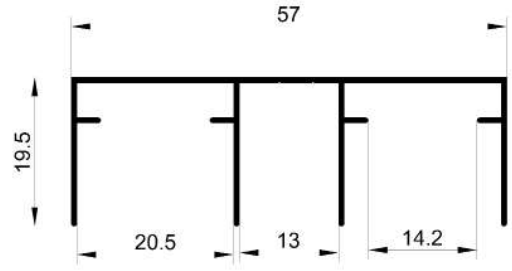

**10390**  
Est Weight: 0.298 kg/m

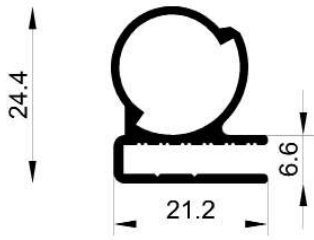

**20400**  
Est Weight: 0.336 kg/m

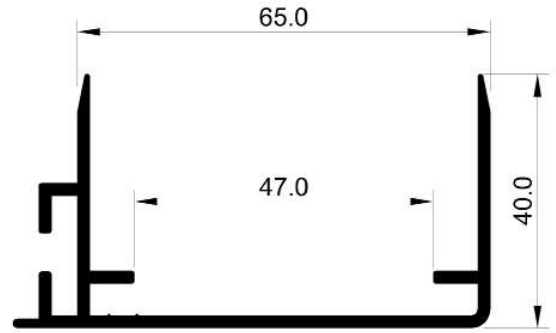

**10294**  
Est Weight: 0.968 kg/m

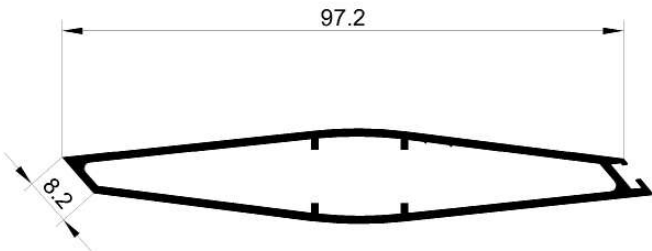

**20252**  
Est Weight: 0.813 kg/m

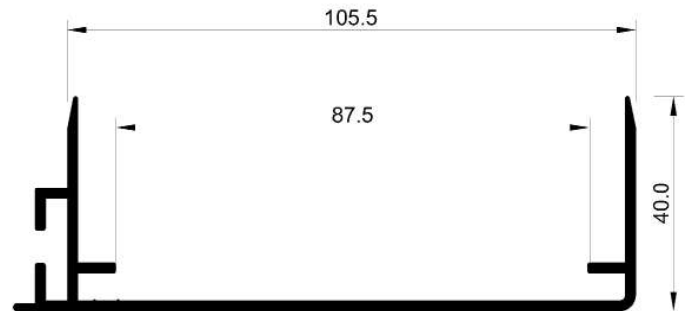

**10295**  
Est Weight: 1.185 kg/m

سالكو

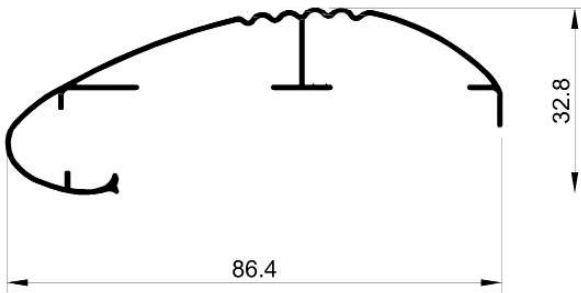

**10189**

**Est Weight: 1.304 kg/m**

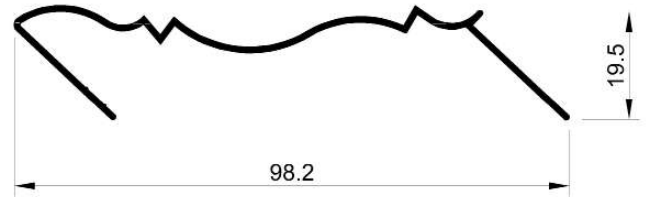

**10165**

**Est Weight: 0.387 kg/m**

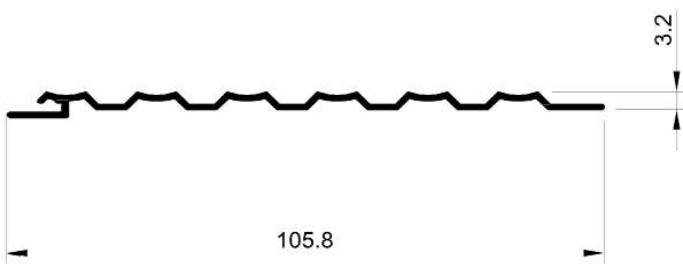

**10026**

**Est Weight: 0.297 kg/m**

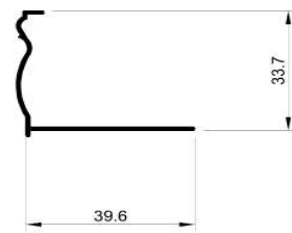

**10216**

**Est Weight: 0.237 kg/m**

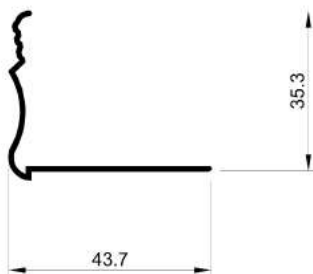

**10080**

**Est Weight: 0.227 kg/m**

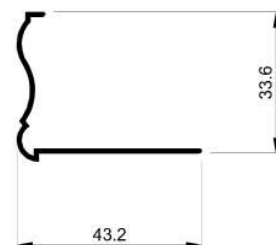

**10082**

**Est Weight: 0.229 kg/m**

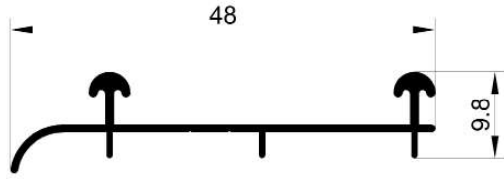

**10389**  
Est Weight: 0.200 kg/m

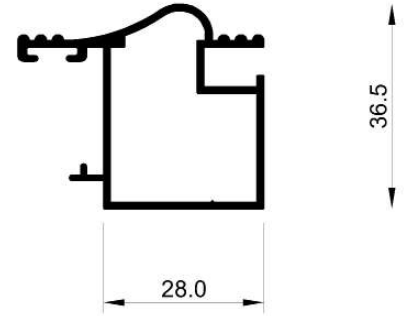

**20066**  
Est Weight: 0.493 kg/m

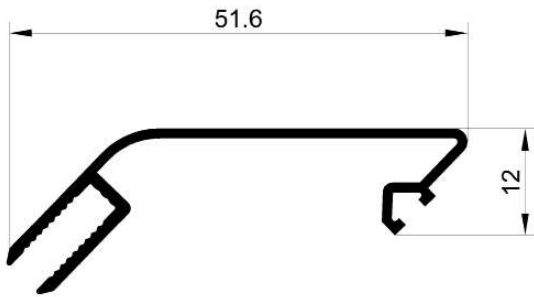

**10391**  
Est Weight: 0.304 kg/m



**10152**  
Est Weight: 0.144 kg/m

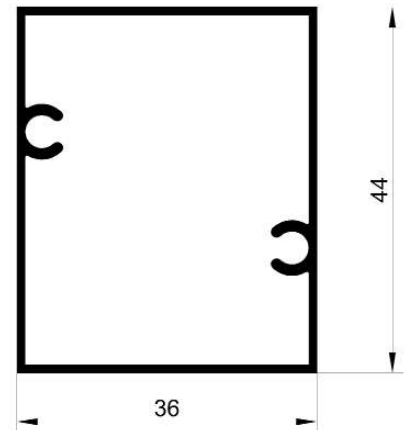

**20420**  
Est Weight: 0.495 kg/m



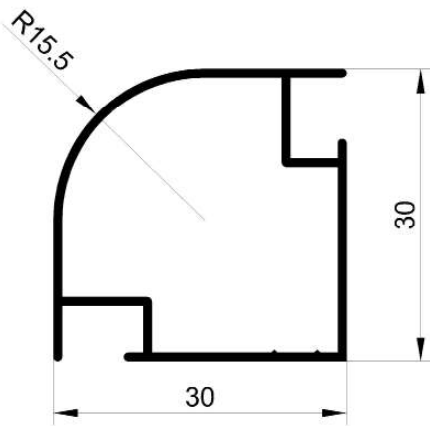

**20352**

**Est Weight: 0.306 kg/m**

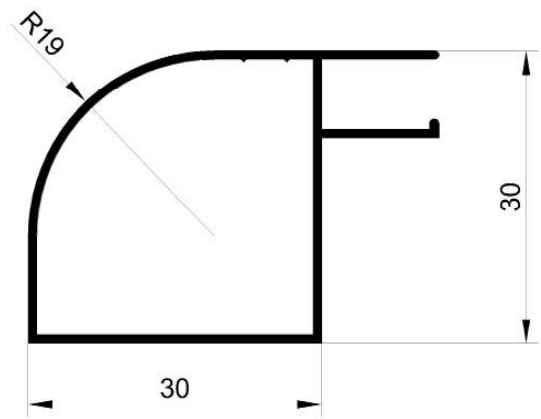

**20328**

**Est Weight: 0.350 kg/m**

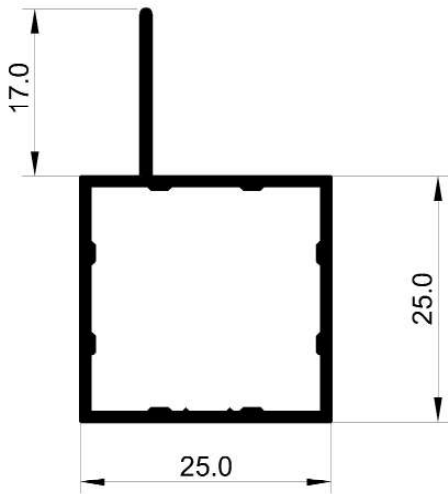

**20202**

**Est Weight: 0.328 kg/m**



**20201**

**Est Weight: 0.276 kg/m**

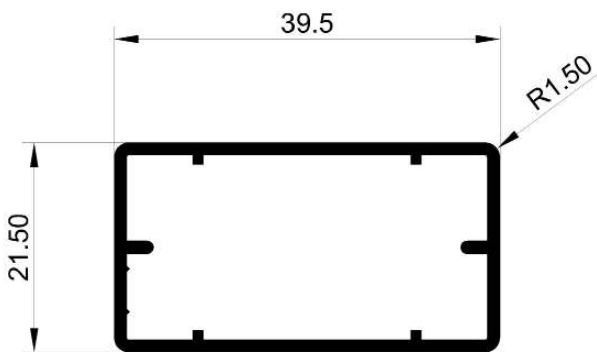

**20274**

**Est Weight: 0.490 kg/m**

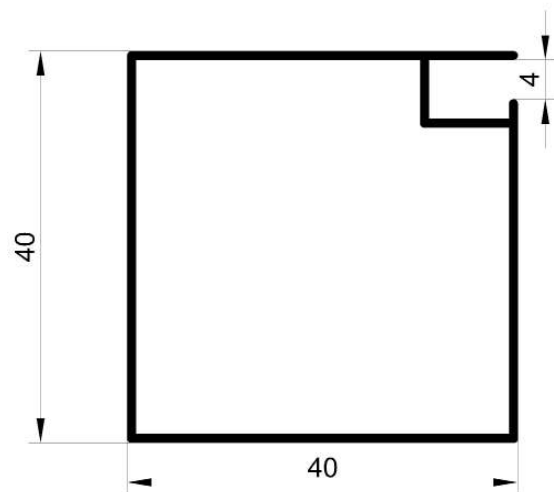

**20397**

**Est Weight: 0.409 kg/m**

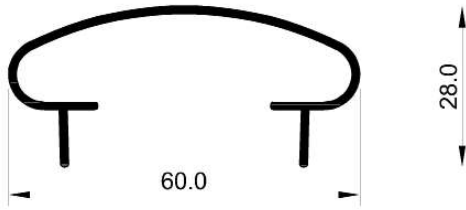

**10029**

**Est Weight: 0.354 kg/m**



**20045**

**Est Weight: 0.351 kg/m**

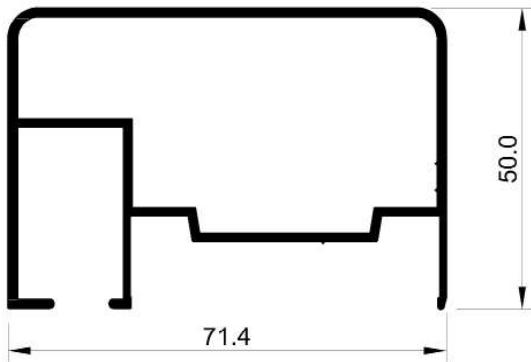

**20187**

**Est Weight: 1.204 kg/m**

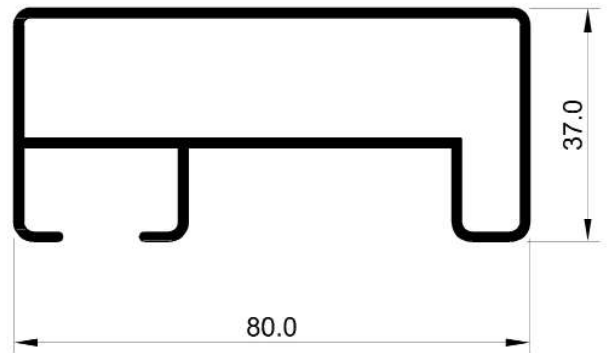

**20132**

**Est Weight: 1.036 kg/m**

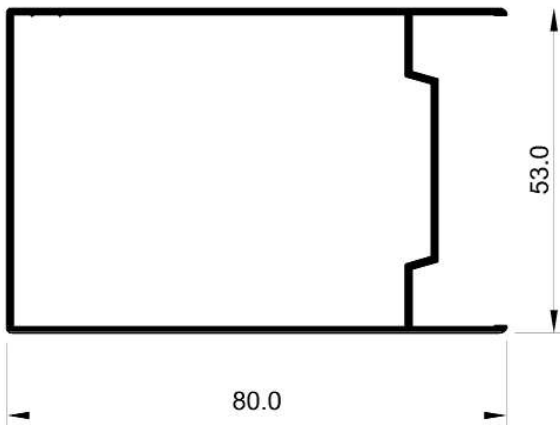

**20138**

**Est Weight: 0.796 kg/m**

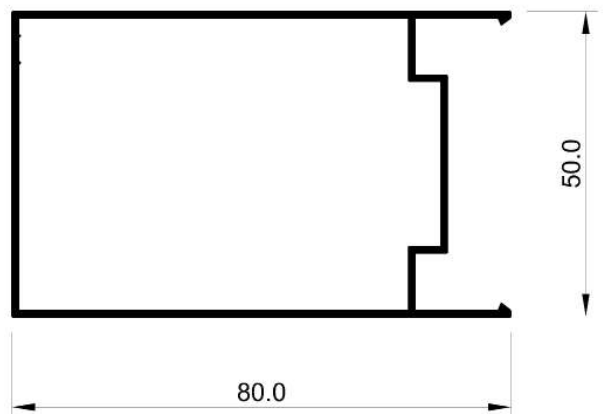

**20198**

**Est Weight: 0.956 kg/m**

سالكو

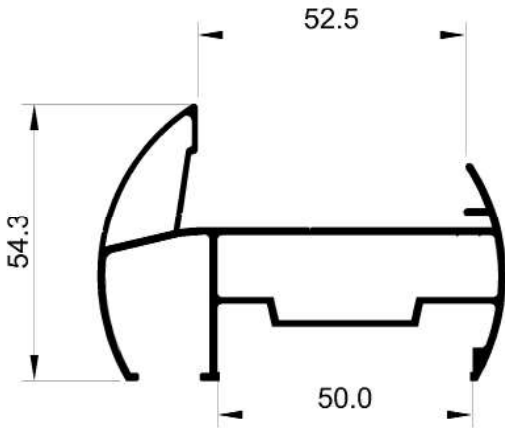

**20255**

**Est Weight: 1.162 kg/m**

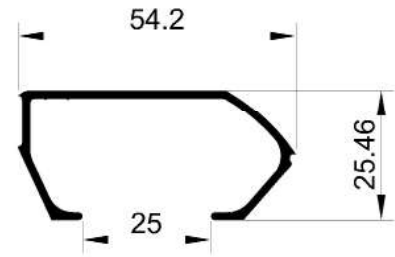

**10256**

**Est Weight: 0.459 kg/m**

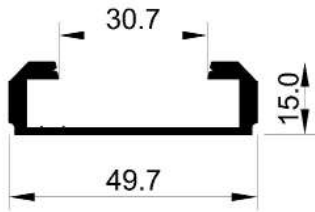

**10173**

**Est Weight: 0.500 kg/m**

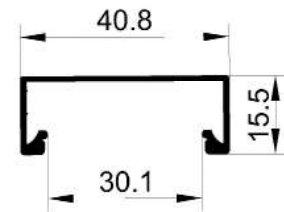

**10282**

**Est Weight: 0.298 kg/m**

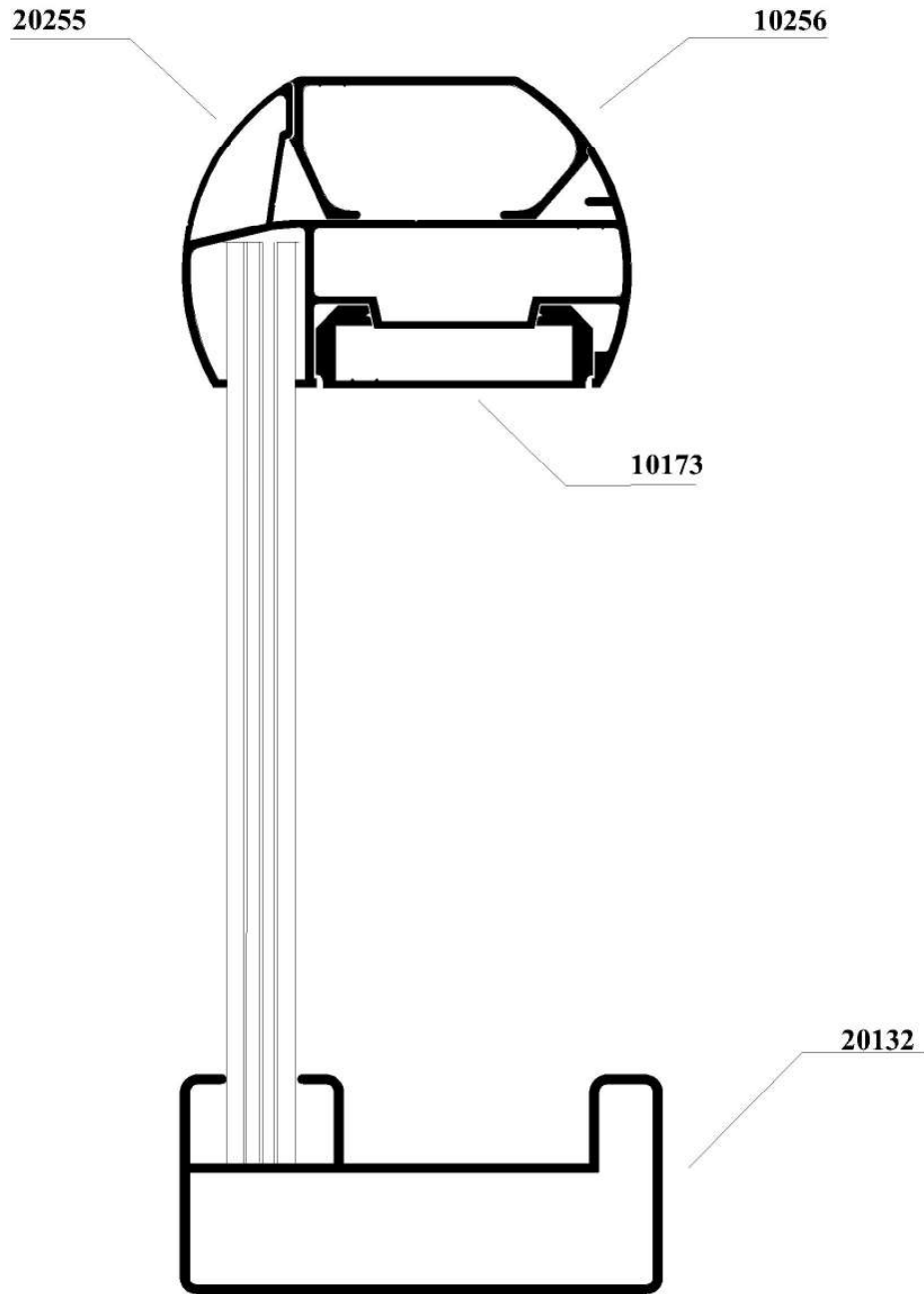

سالكو

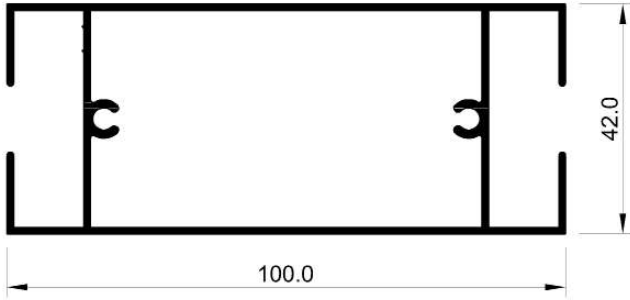

**20028**

**Est Weight: 1.177 kg/m**

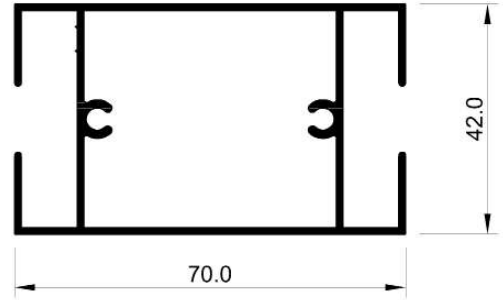

**20067**

**Est Weight: 1.048 kg/m**

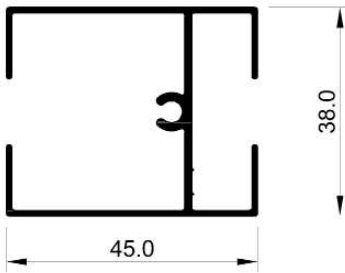

**10046**

**Est Weight: 0.558 kg/m**

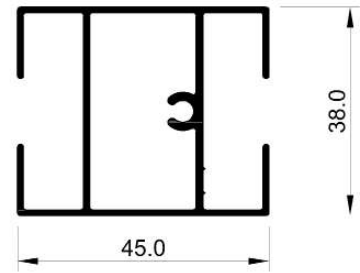

**20027**

**Est Weight: 0.660 kg/m**

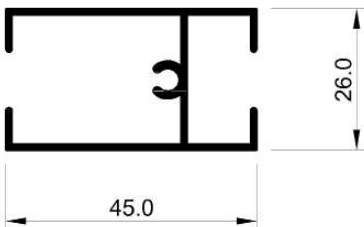

**10060**

**Est Weight: 0.439 kg/m**

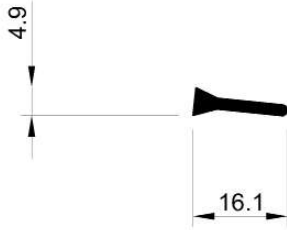

**10199**  
Est Weight: 0.096 kg/m

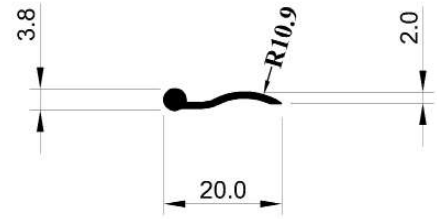

**10196**  
Est Weight: 0.074 kg/m

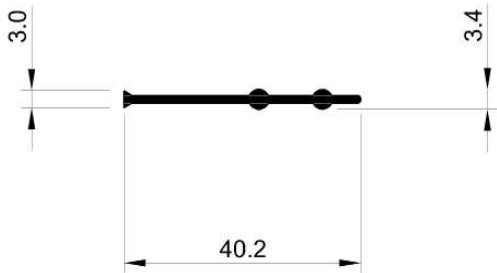

**10197**  
Est Weight: 0.179 kg/m

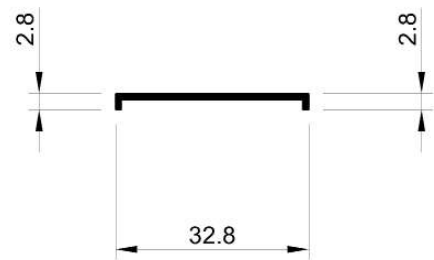

**10202**  
Est Weight: 0.099 kg/m

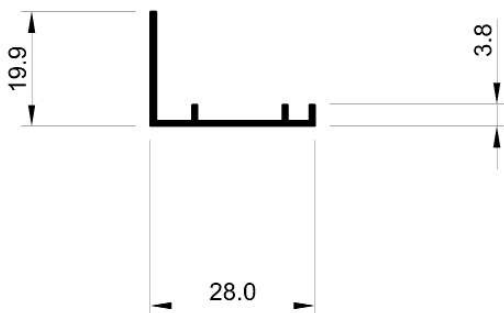

**10205**  
Est Weight: 0.160 kg/m

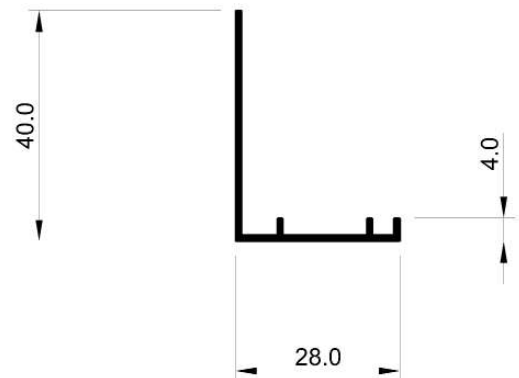

**10201**  
Est Weight: 0.230 kg/m

## مسالك

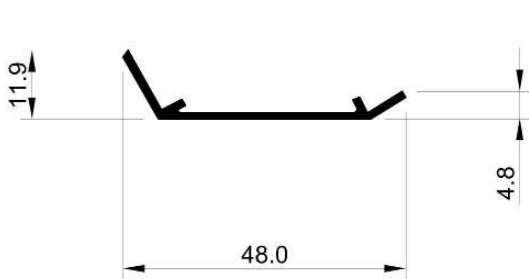

**10203**  
Est Weight: 0.204 kg/m

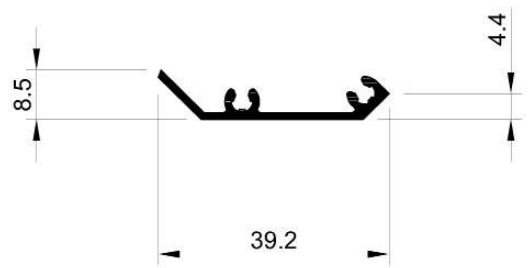

**10204**  
Est Weight: 0.207 kg/m

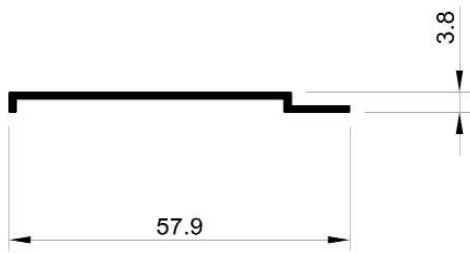

**10208**  
Est Weight: 0.205 kg/m

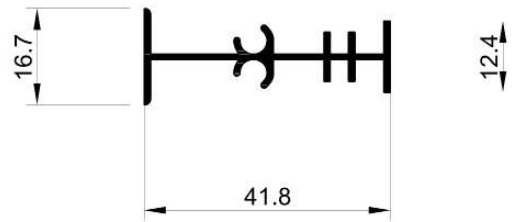

**10198**  
Est Weight: 0.290 kg/m

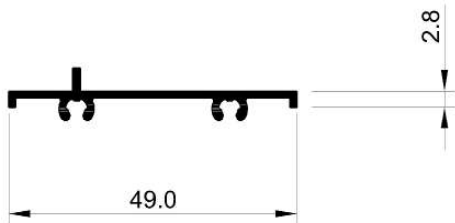

**10206**  
Est Weight: 0.248 kg/m

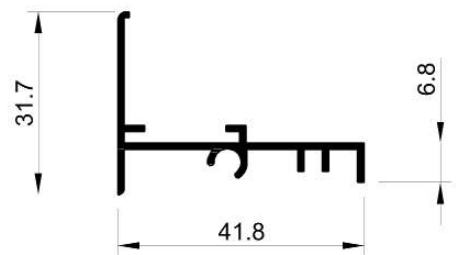

**10207**  
Est Weight: 0.310 kg/m

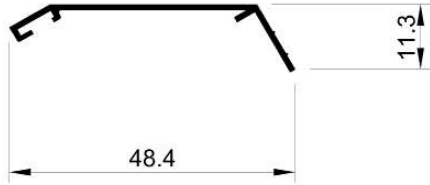

**10223**  
Est Weight: 0.202 kg/m

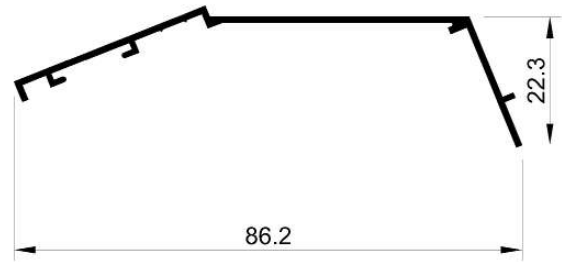

**10224**  
Est Weight: 0.360 kg/m

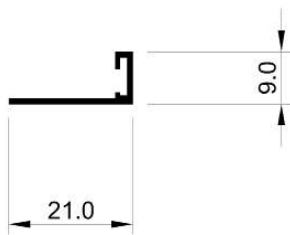

**10237**  
Est Weight: 0.101 kg/m



**10238**  
Est Weight: 0.146 kg/m

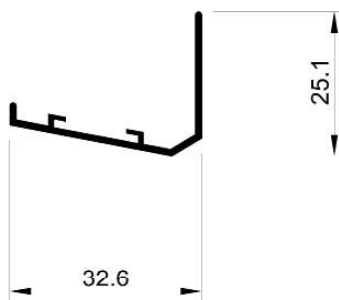

**10239**  
Est Weight: 0.204 kg/m

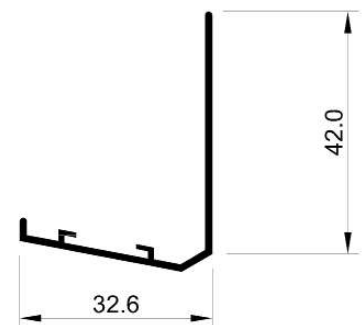

**10240**  
Est Weight: 0.269 kg/m



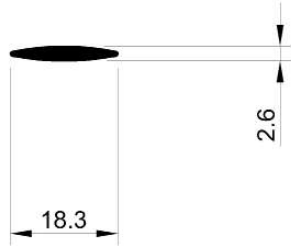

**10200**  
Est Weight: 0.097 kg/m

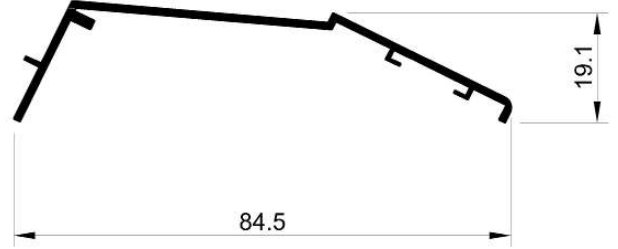

**10209**  
Est Weight: 0.386 kg/m

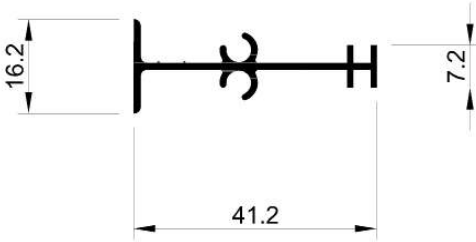

**10219**  
Est Weight: 0.273 kg/m

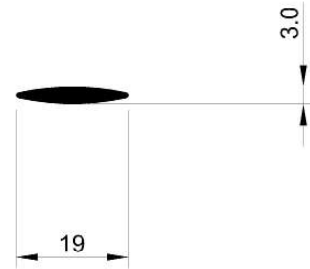

**10220**  
Est Weight: 0.140 kg/m

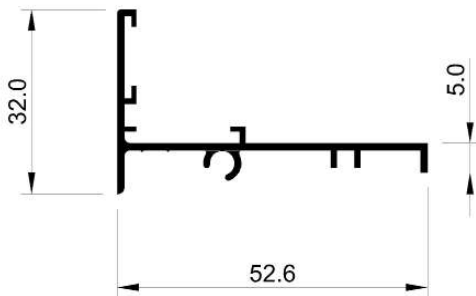

**10221**  
Est Weight: 0.350 kg/m

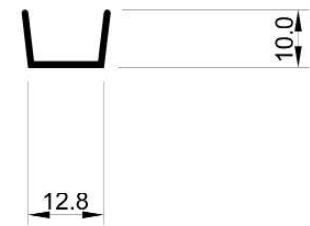

**10222**  
Est Weight: 0.091 kg/m



**10241**  
Est Weight: 0.116 kg/m

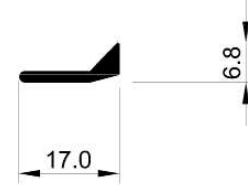

**10242**  
Est Weight: 0.116 kg/m

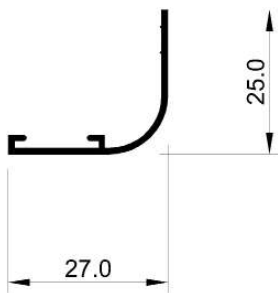

**10246**  
Est Weight: 0.163 kg/m

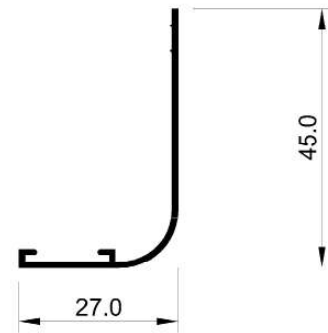

**10247**  
Est Weight: 0.223 kg/m

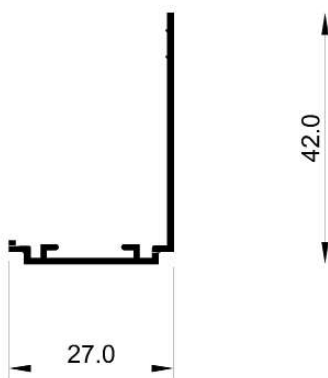

**10248**  
Est Weight: 0.239 kg/m

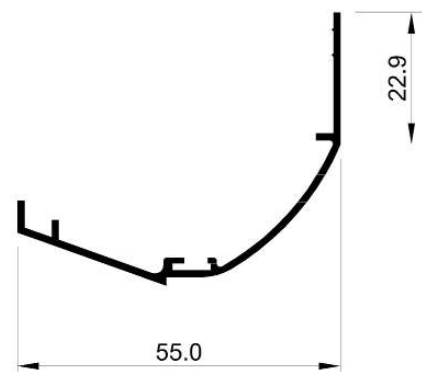

**10249**  
Est Weight: 0.369 kg/m

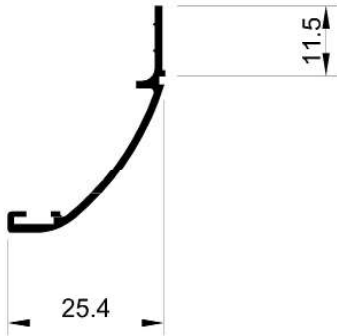

**10250**  
Est Weight: 0.190 kg/m

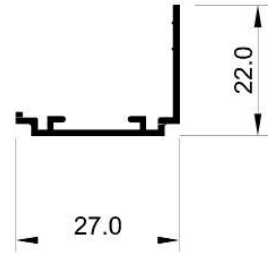

**10251**  
Est Weight: 0.172 kg/m

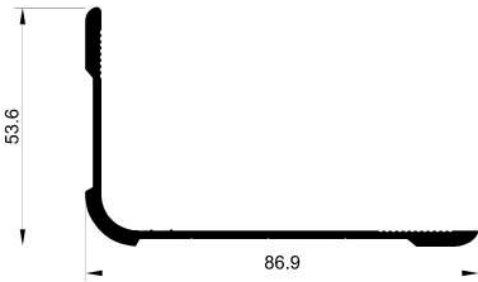

**10167**  
Est Weight: 0.780 kg/m

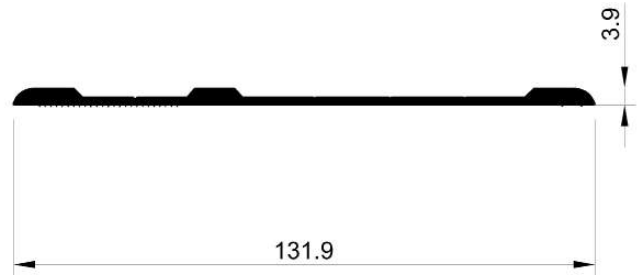

**10168**  
Est Weight: 0.843 kg/m

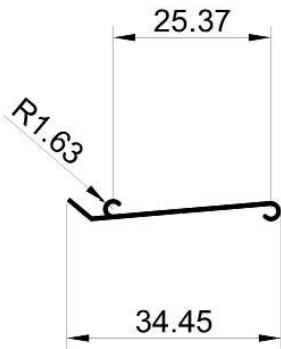

**10258**  
Est Weight: 0.353 kg/m

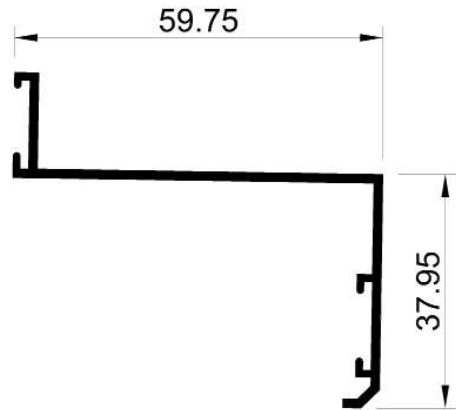

**10259**  
Est Weight: 0.518 kg/m

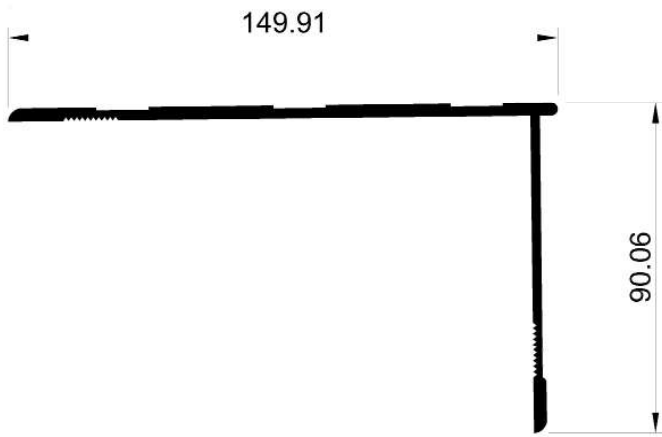

**10262**

**Est Weight: 1.902 kg/m**

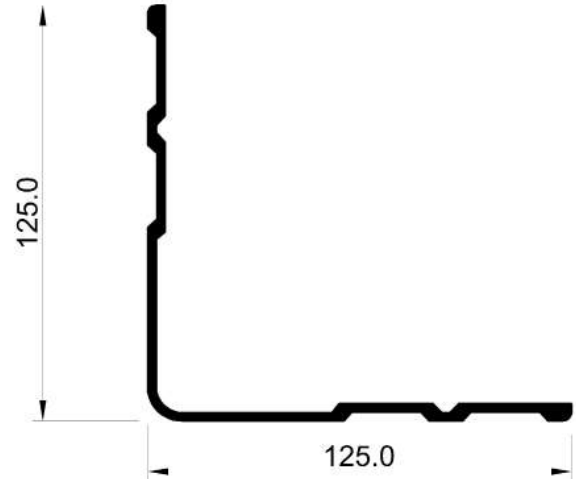

**10101**

**Est Weight: 2.000 kg/m**

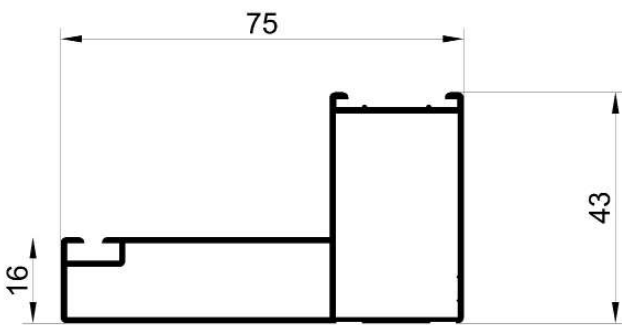

**20308**

**Est Weight: 0.772 kg/m**

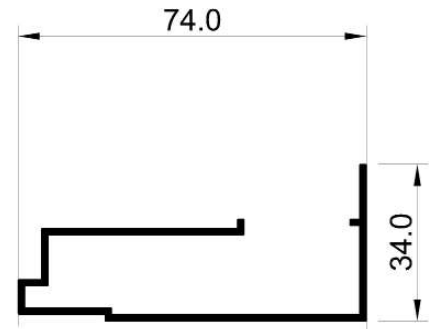

**10138**

**Est Weight: 0.665 kg/m**

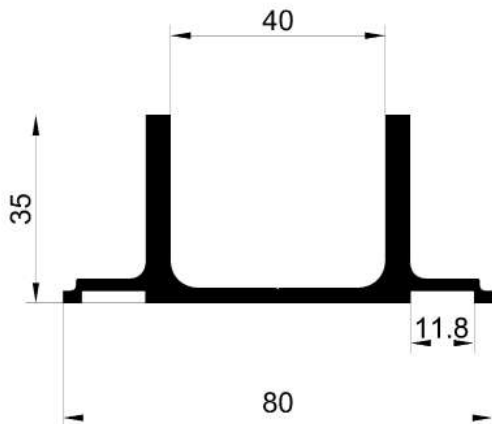

**10055**

**Est Weight: 1.420 kg/m**

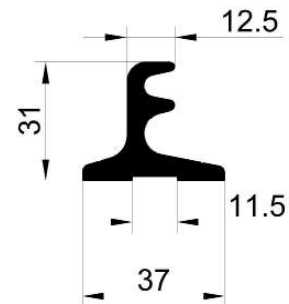

**10053**

**Est Weight: 1.018 kg/m**

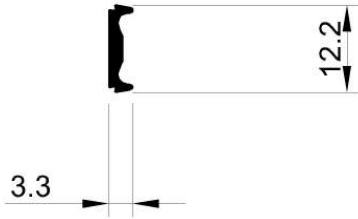

**10214**  
Est Weight: 0.059 kg/m

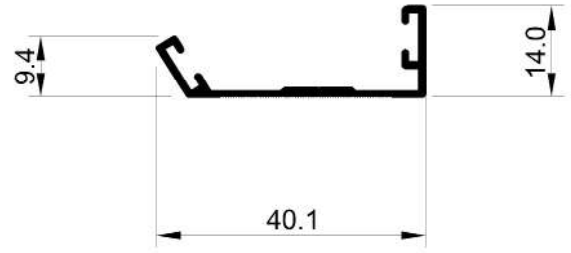

**10164**  
Est Weight: 0.218 kg/m

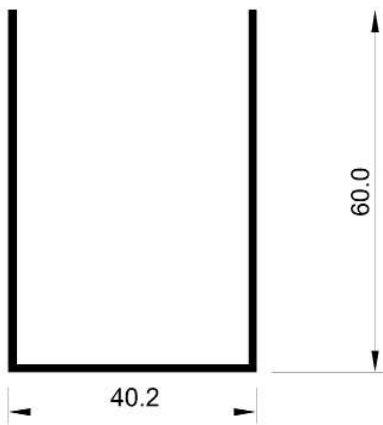

**10228**  
Est Weight: 0.552 kg/m

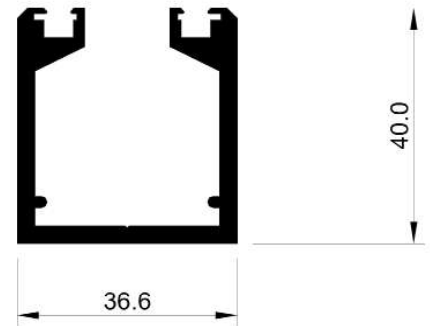

**10229**  
Est Weight: 1.161 kg/m

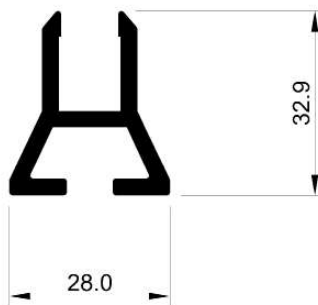

**10230**  
Est Weight: 0.733 kg/m

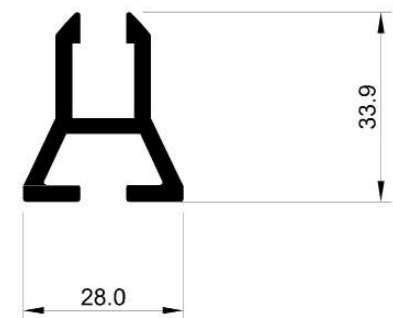

**10231**  
Est Weight: 0.764 kg/m

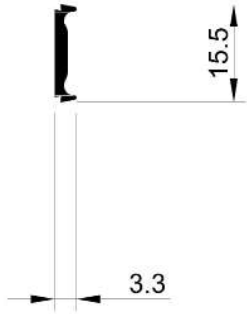

**10254**

Est Weight: 0.077 kg/m

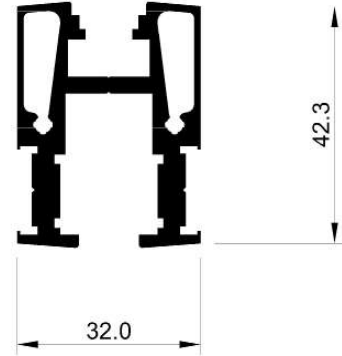

**20245**

Est Weight: 1.300 kg/m

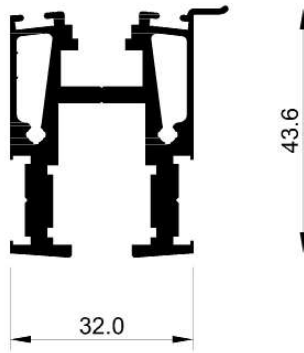

**20244**

Est Weight: 1.330 kg/m

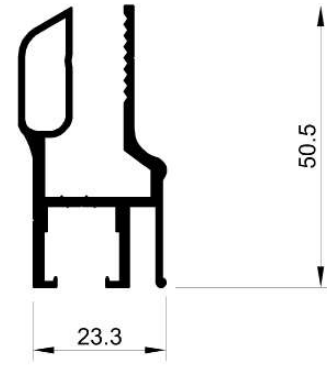

**20193**

Est Weight: 0.768 kg/m

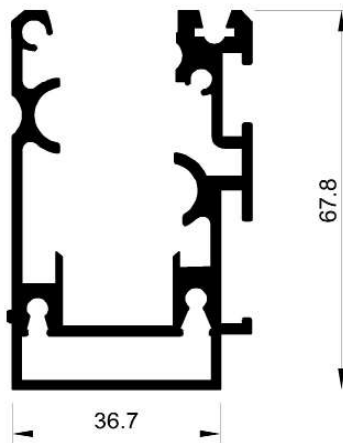

**20222**

Est Weight: 1.693 kg/m

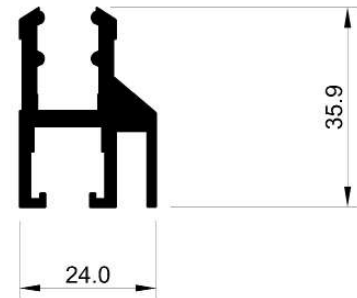

**10147**

Est Weight: 0.796 kg/m

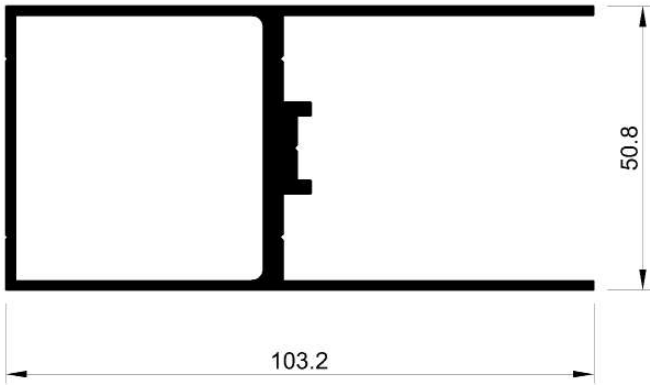

**20139**  
Est Weight: 1.731 kg/m

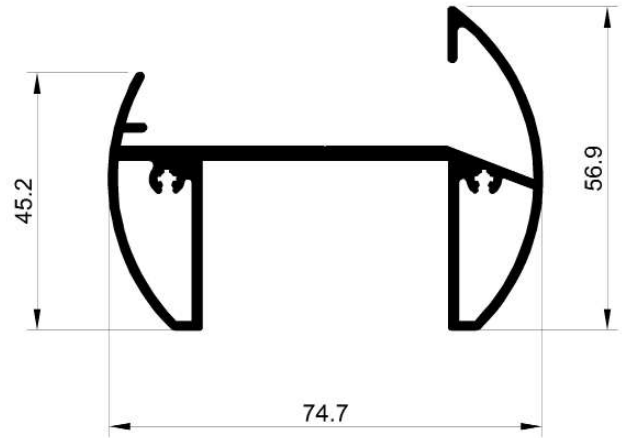

**20220**  
Est Weight: 1.380 kg/m

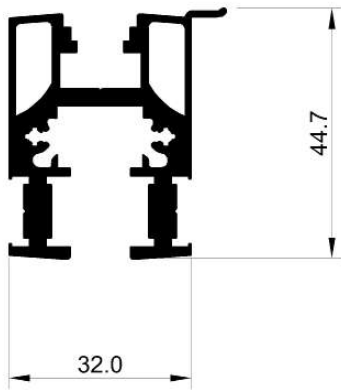

**20218**  
Est Weight: 1.330 kg/m

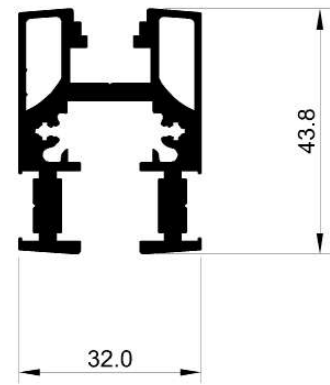

**20219**  
Est Weight: 1.310 kg/m

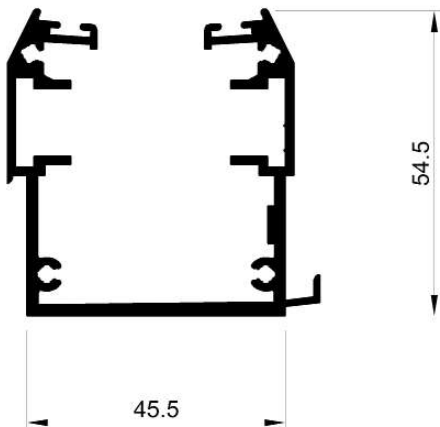

**10212**  
Est Weight: 1.289 kg/m

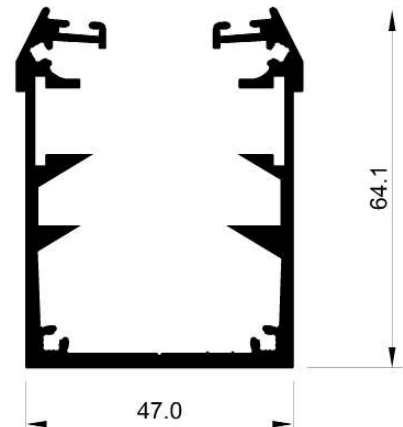

**10213**  
Est Weight: 1.570 kg/m

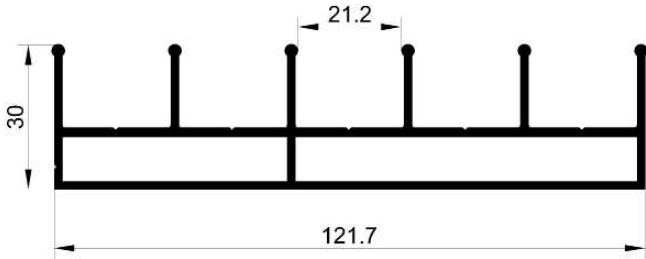

**20405**

Est Weight: 1.848 kg/m

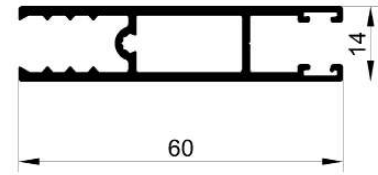

**20406**

Est Weight: 0.691 kg/m

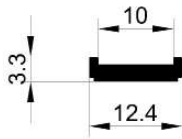

**10140**

Est Weight: 1.848 kg/m

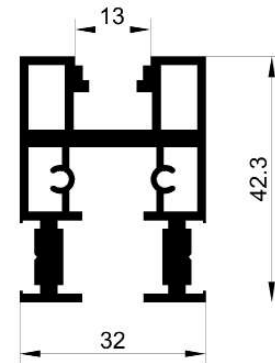

**20140**

Est Weight: 1.235 kg/m

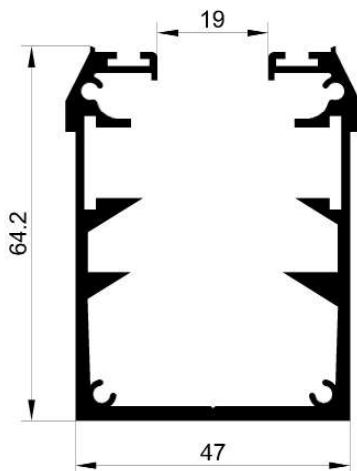

**10142**

Est Weight: 1.537 kg/m

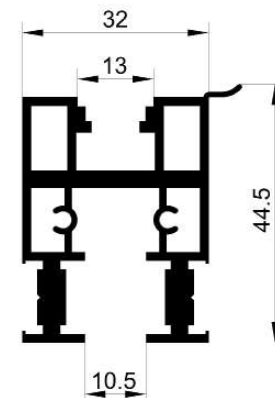

**20206**

Est Weight: 1.255 kg/m



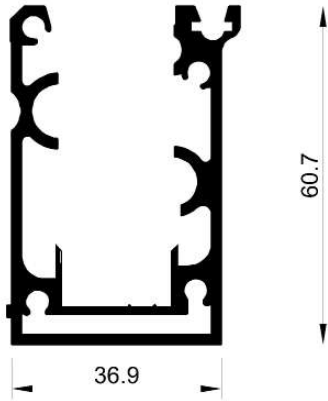

**20194**  
Est Weight: 1.528 kg/m

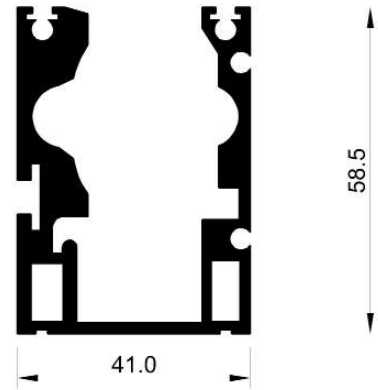

**20149**  
Est Weight: 1.963 kg/m

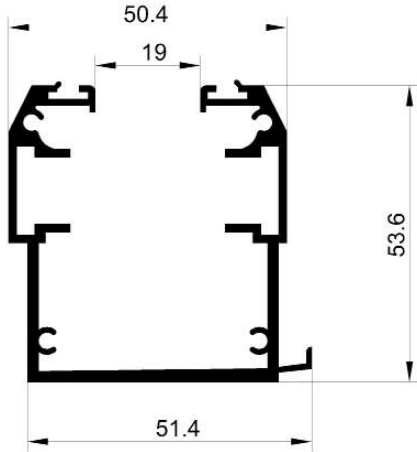

**10141**  
Est Weight: 1.228 kg/m

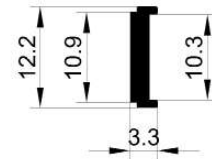

**10146**  
Est Weight: 0.078 kg/m

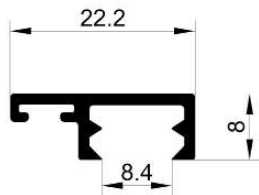

**10395**  
Est Weight: 0.162 kg/m

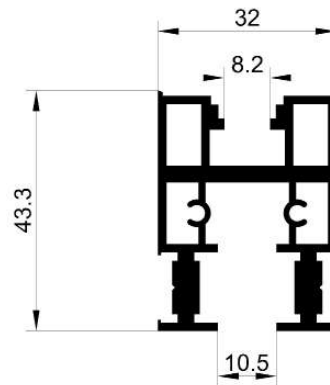

**20207**  
Est Weight: 1.241 kg/m

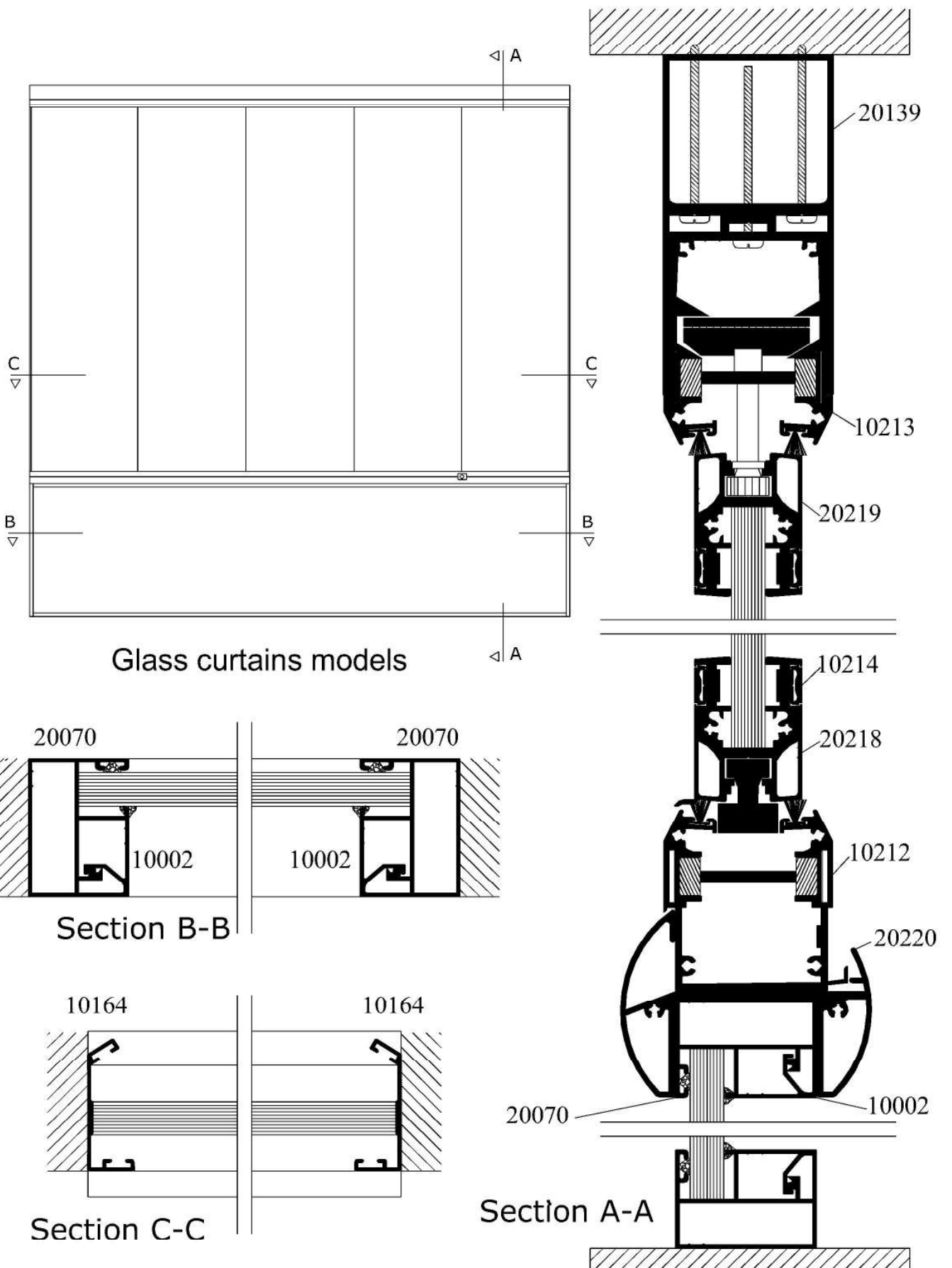

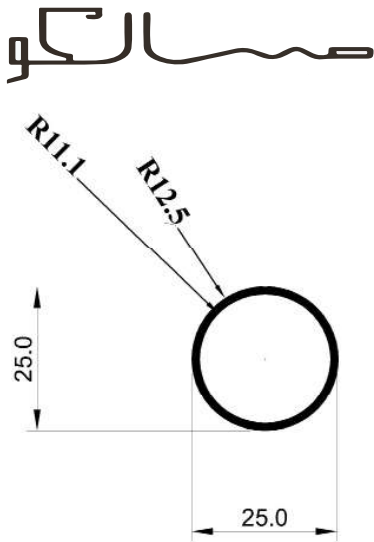

**20227**  
Est Weight: 0.280 kg/m

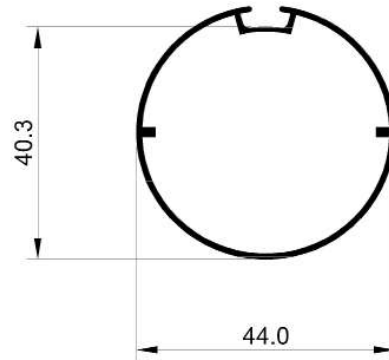

**20225**  
Est Weight: 0.410 kg/m

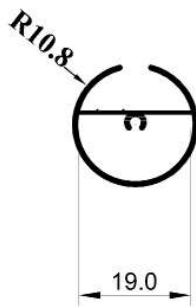

**20243**  
Est Weight: 0.250 kg/m

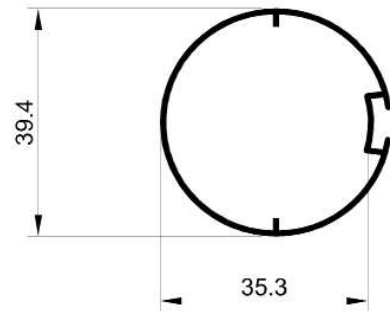

**20242**  
Est Weight: 0.400 kg/m

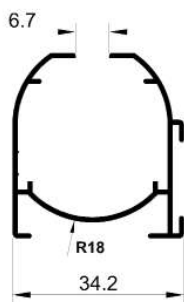

**10269**  
Est Weight: 0.490 kg/m

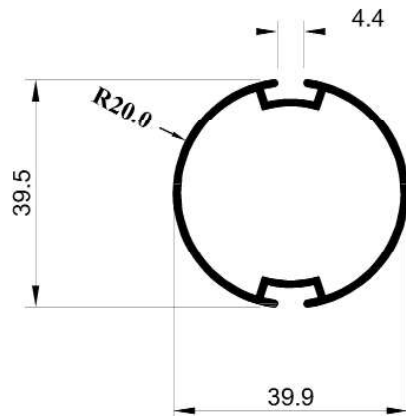

**20126**  
Est Weight: 0.540 kg/m

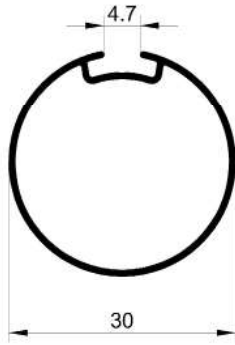

**20356**

**Est Weight: 0.244 kg/m**

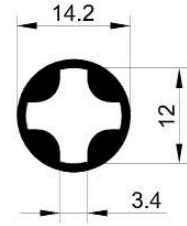

**20357**

**Est Weight: 0.222 kg/m**

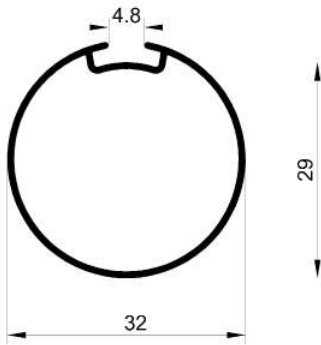

**20396**

**Est Weight: 0.260 kg/m**

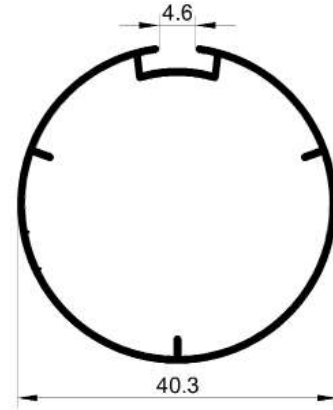

**20362**

**Est Weight: 0.363 kg/m**

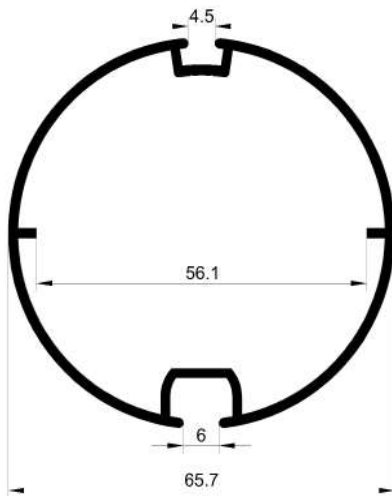

**20349**

**Est Weight: 1.078 kg/m**

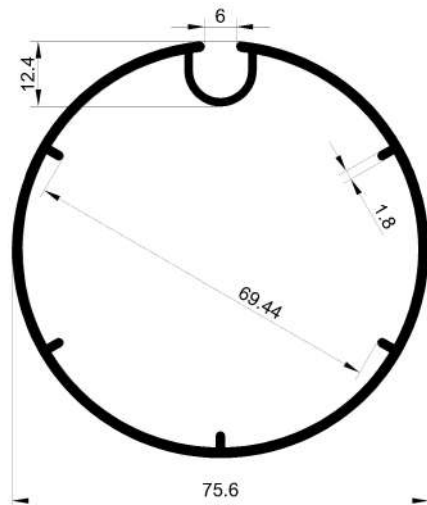

**20348**

**Est Weight: 1.466 kg/m**

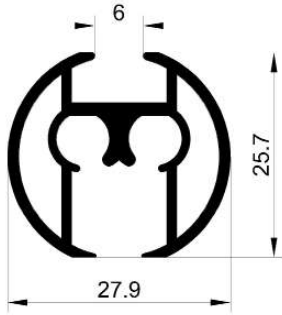

**20381**

**Est Weight: 0.513 kg/m**

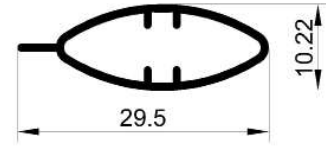

**20326**

**Est Weight: 0.168 kg/m**

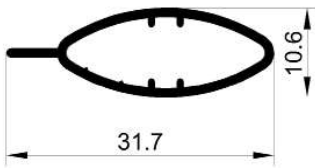

**20361**

**Est Weight: 0.192 kg/m**

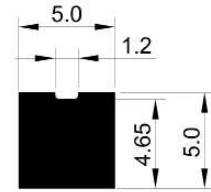

**10270**

**Est Weight: 0.072 kg/m**

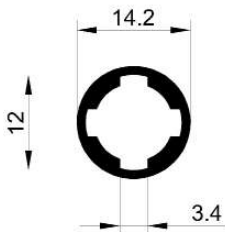

**20417**

**Est Weight: 0.184 kg/m**

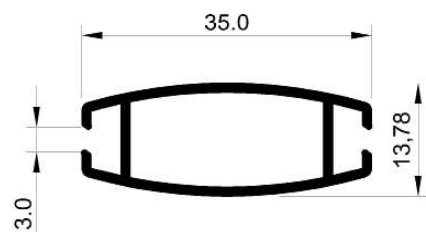

**20285**

**Est Weight: 0.307 kg/m**

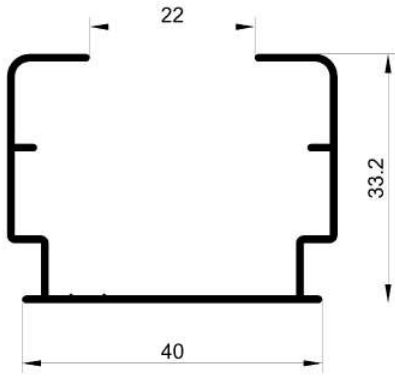

**10392**

**Est Weight: 0.367 kg/m**



**20360**

**Est Weight: 0.242 kg/m**

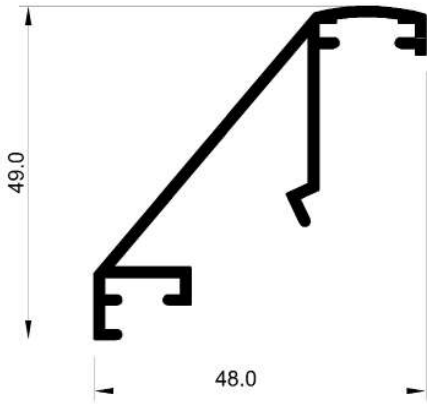

**10136**

**Est Weight: 0.568 kg/m**

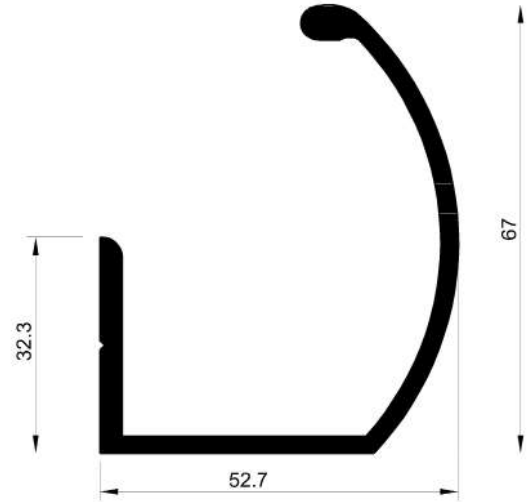

**10137**

**Est Weight: 1.125 kg/m**

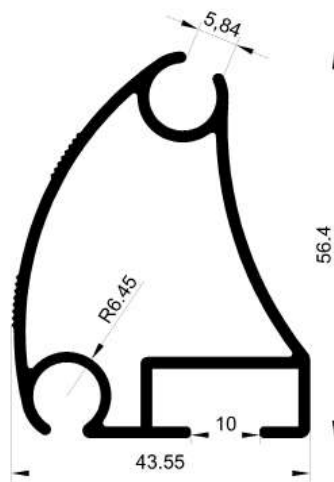

**20347**

**Est Weight: 0.978 kg/m**

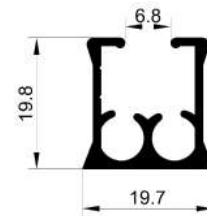

**10393**

**Est Weight: 0.406 kg/m**

سلك

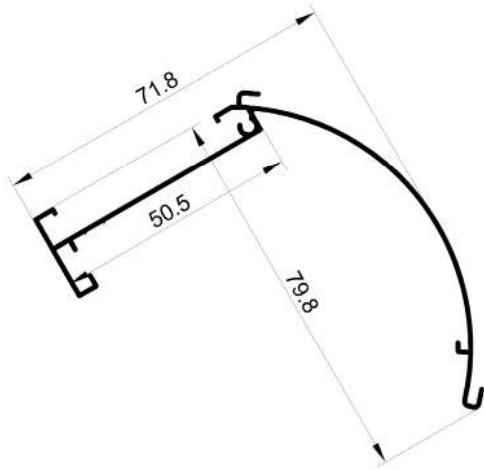

**10316**

Est Weight: 0.550 kg/m

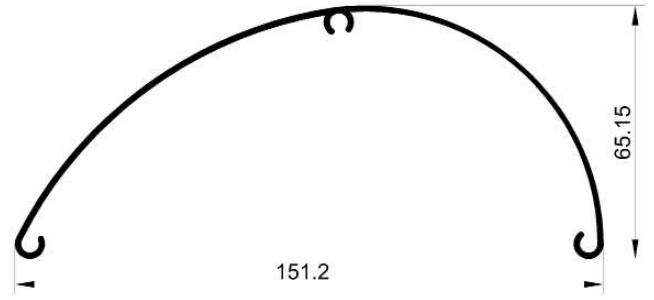

**10353**

Est Weight: 1 kg/m

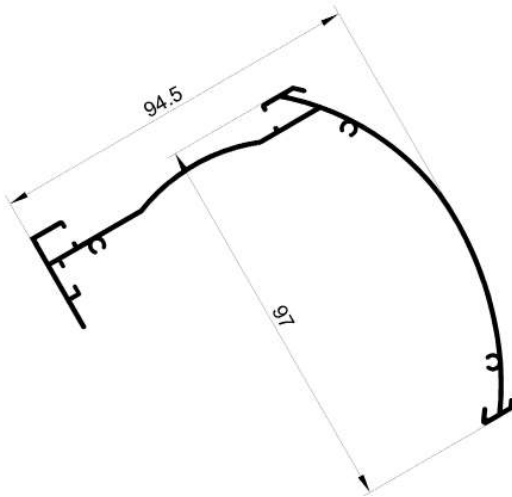

**10362**

Est Weight: 0.860 kg/m

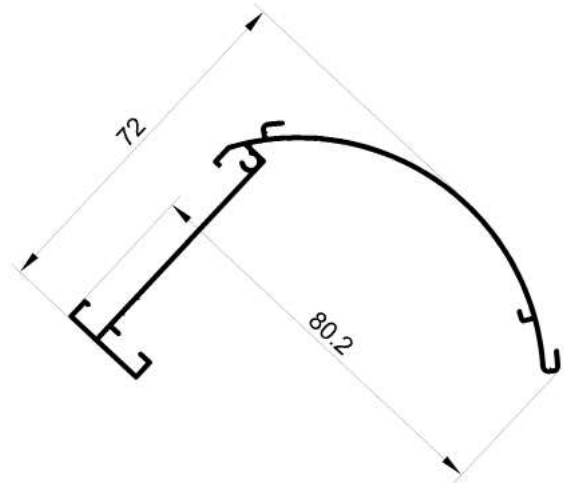

**10365**

Est Weight: 0.550 kg/m

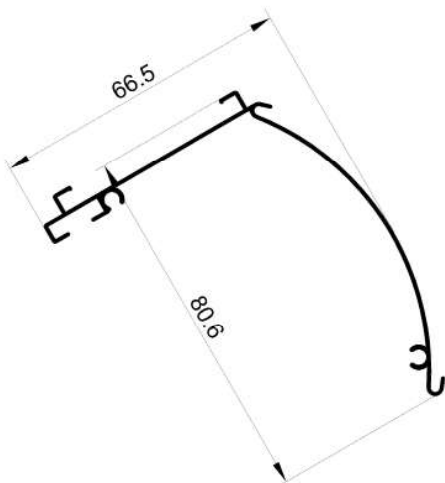

**10376**

Est Weight: 0.466 kg/m

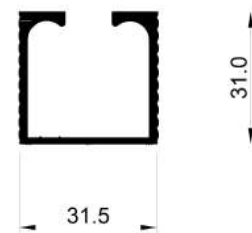

**10169**

Est Weight: 0.550 kg/m

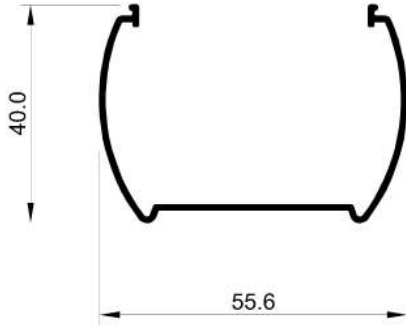

**10074**  
Est Weight: 0.362 kg/m

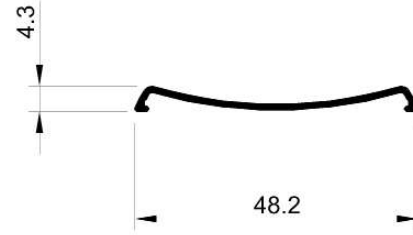

**10073**  
Est Weight: 0.147 kg/m

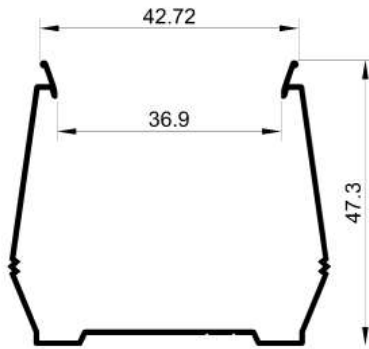

**10292**  
Est Weight: 0.390 kg/m

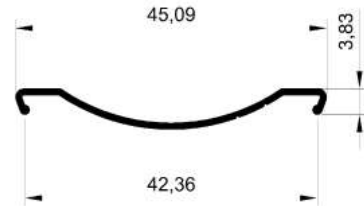

**10293**  
Est Weight: 0.160 kg/m

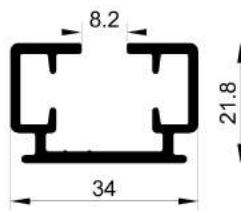

**10375**  
Est Weight: 0.573 kg/m

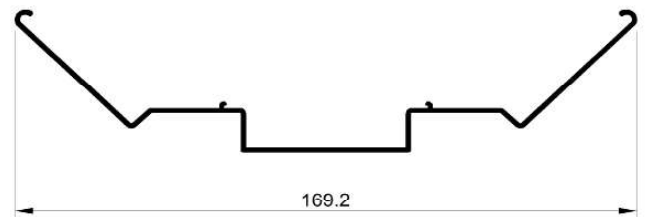

**10135**  
Est Weight: 0.687 kg/m



سلك

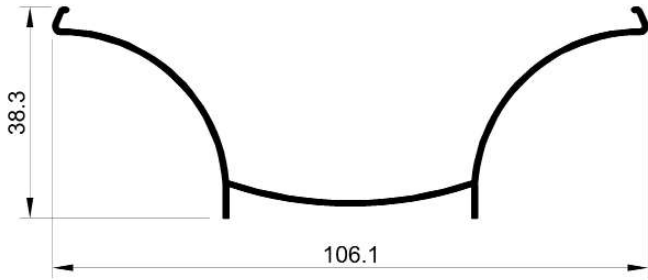

**10134**

**Est Weight: 0.424 kg/m**

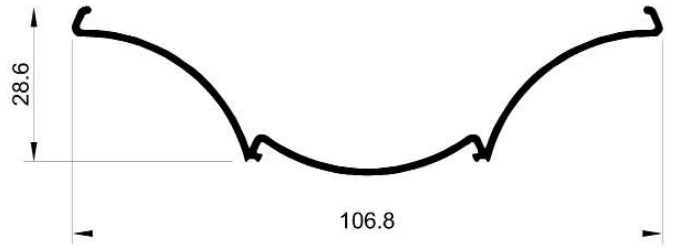

**10116**

**Est Weight: 0.439 kg/m**

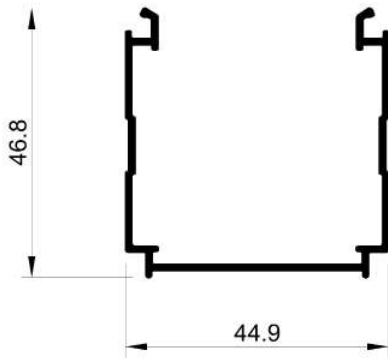

**10076**

**Est Weight: 0.459 kg/m**

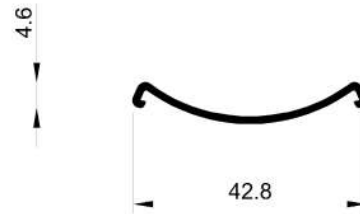

**10075**

**Est Weight: 0.168 kg/m**

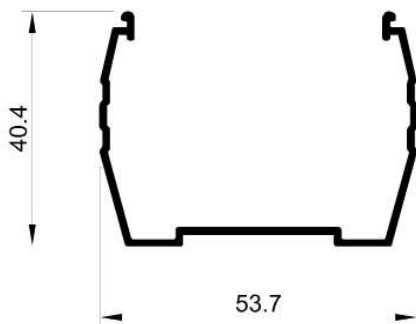

**10114**

**Est Weight: 0.414 kg/m**

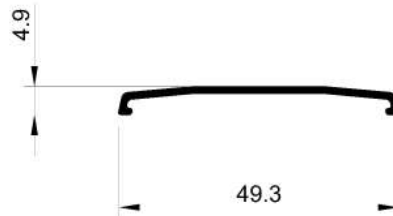

**10115**

**Est Weight: 0.168 kg/m**



**10041**  
Est Weight: 0.316 kg/m

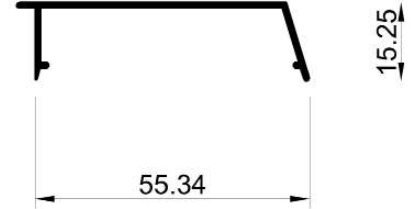

**10144**  
Est Weight: 0.253 kg/m



**10040**  
Est Weight: 0.471 kg/m

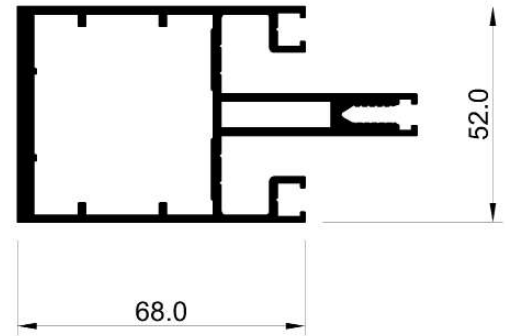

**20063**  
Est Weight: 2.400 kg/m

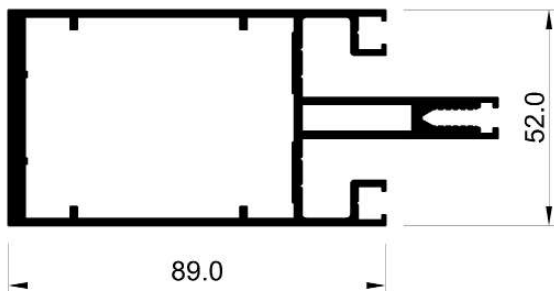

**20064**  
Est Weight: 2.456 kg/m

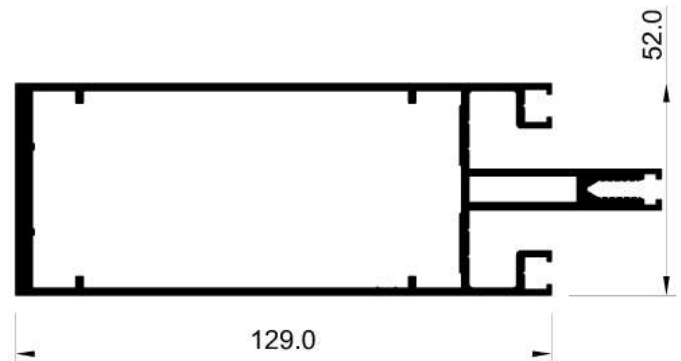

**20065**  
Est Weight: 3.283 kg/m

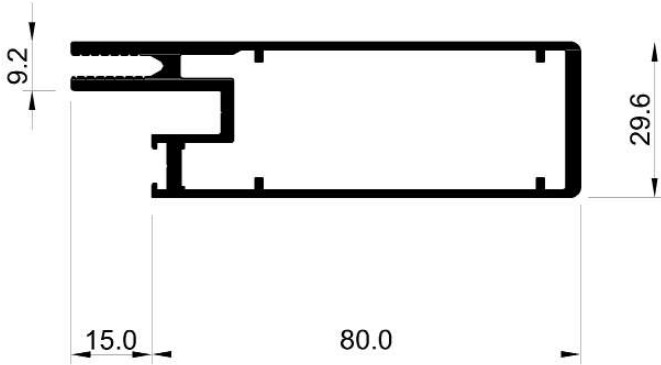

**20179**  
Est Weight: 1.446 kg/m

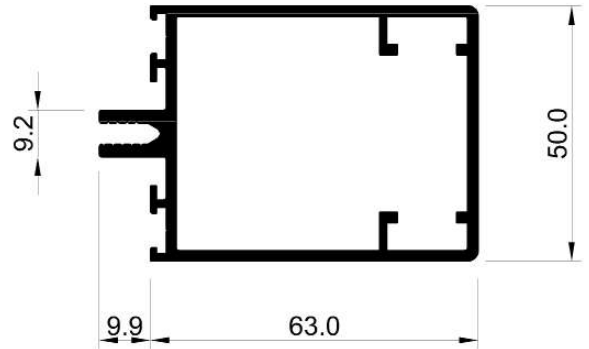

**20178**  
Est Weight: 1.566 kg/m

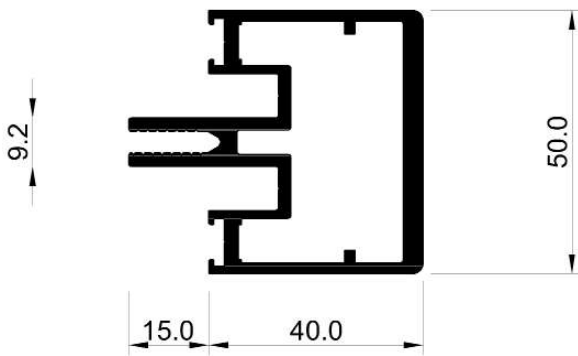

**20177**  
Est Weight: 1.731 kg/m

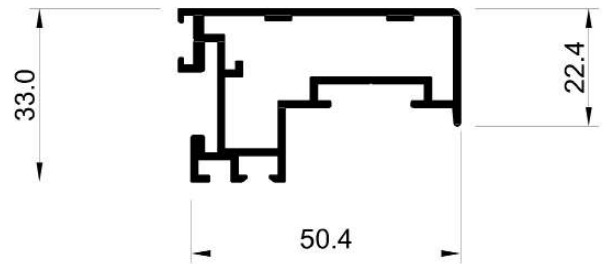

**20176**  
Est Weight: 0.811 kg/m

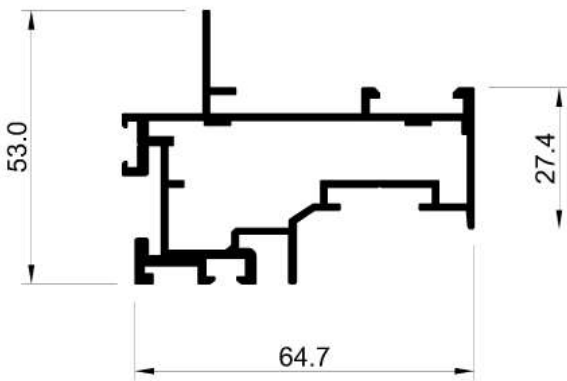

**20175**  
Est Weight: 1.183 kg/m

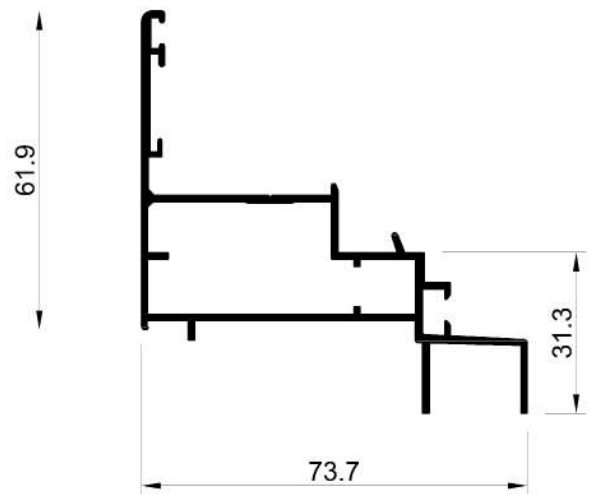

**20180**  
Est Weight: 1.009 kg/m

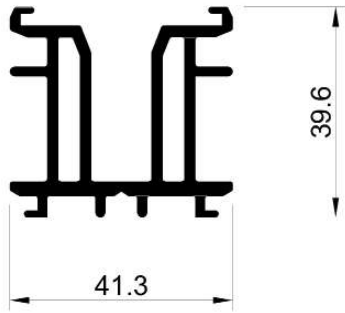

**20223**  
Est Weight: 1.270 kg/m

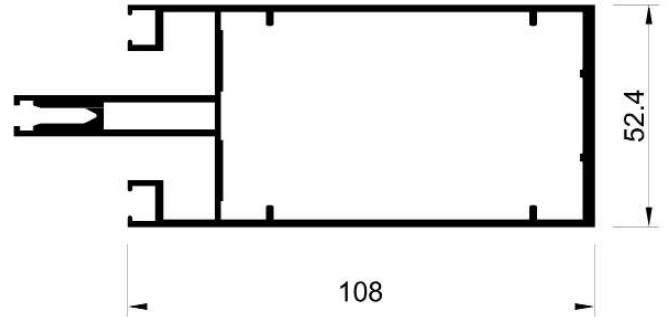

**20224**  
Est Weight: 2.366 kg/m

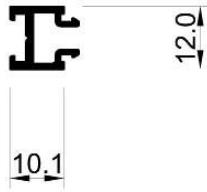

**10163**  
Est Weight: 0.163 kg/m

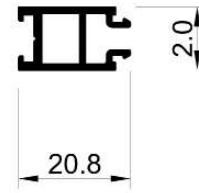

**20181**  
Est Weight: 0.228 kg/m

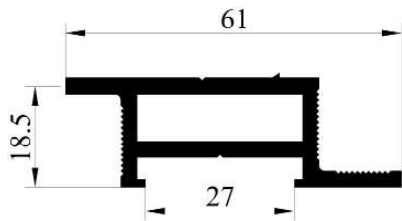

**20373**  
Est Weight: 1.005 kg/m

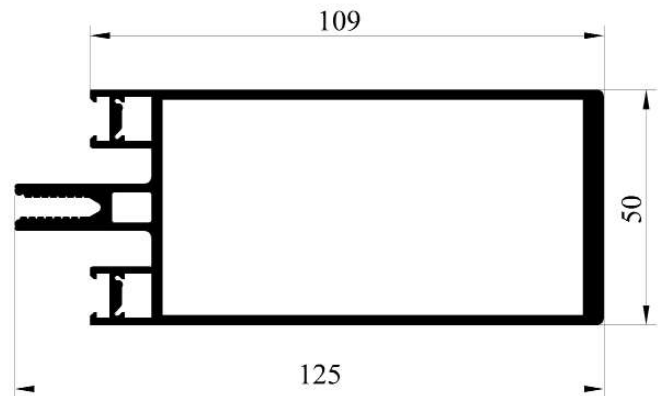

**20307**  
Est Weight: 2.716 kg/m

سالكو

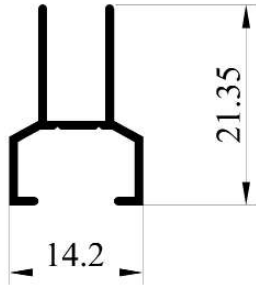

**10366**

**Est Weight: 0.138 kg/m**

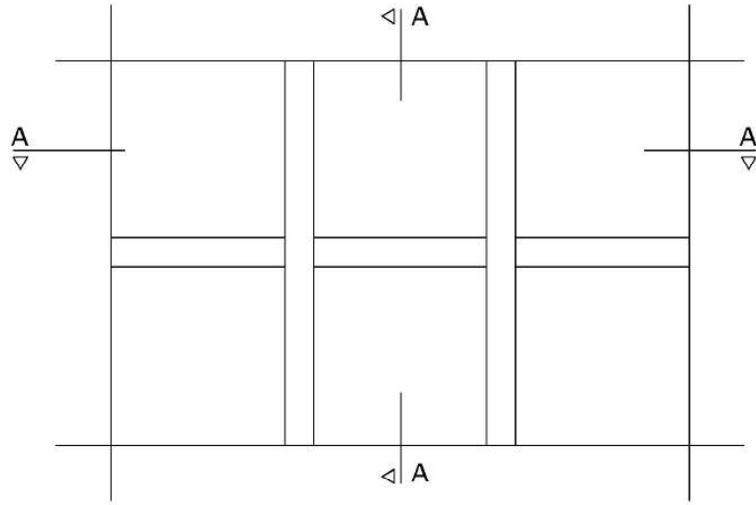

## نموذج كارتن وول

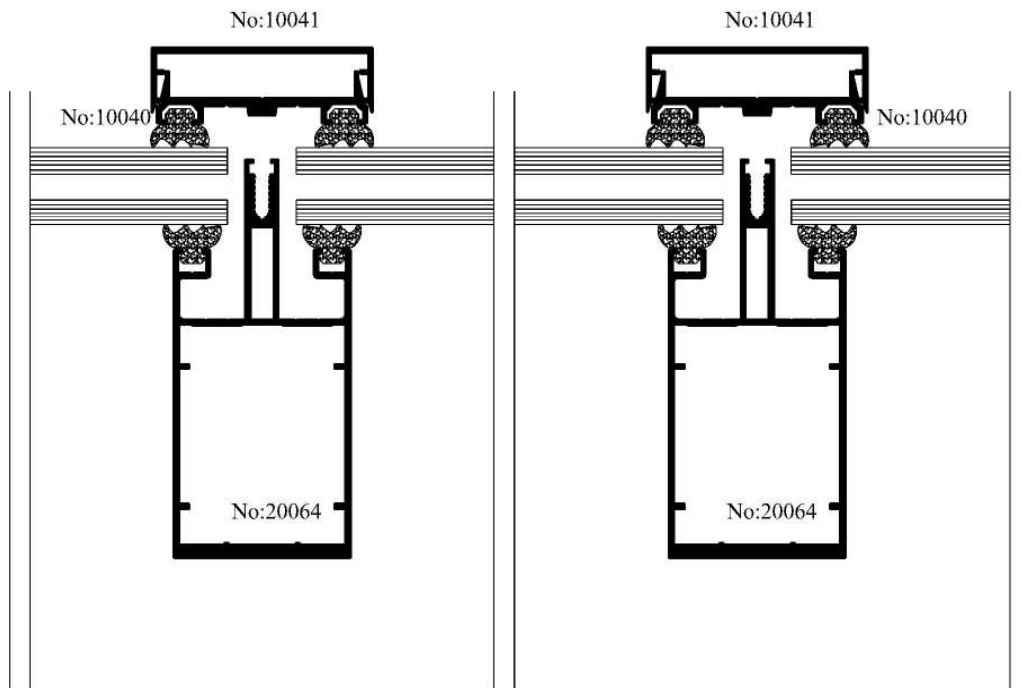

Section A-A

سالكو

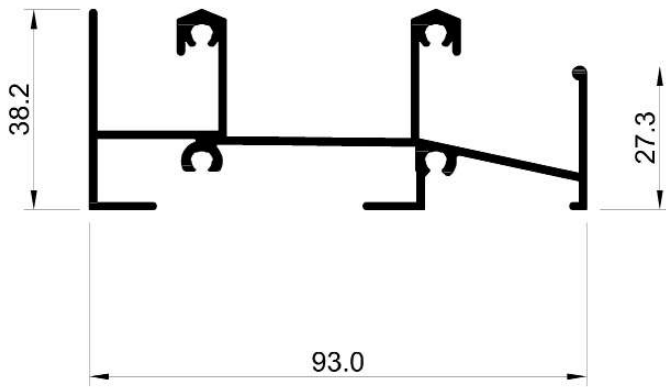

**10091**

Est Weight: 1.106 kg/m

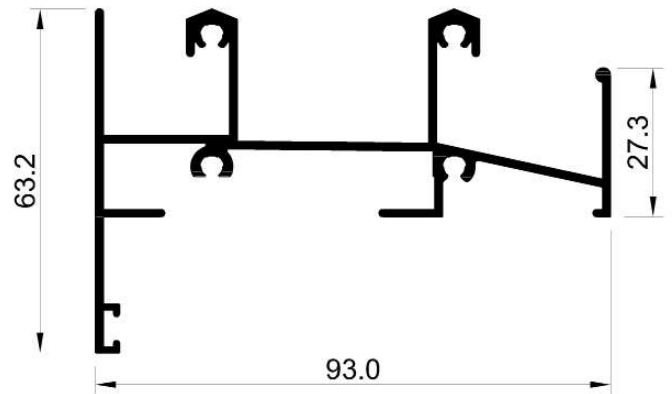

**10092**

Est Weight: 1.325 kg/m

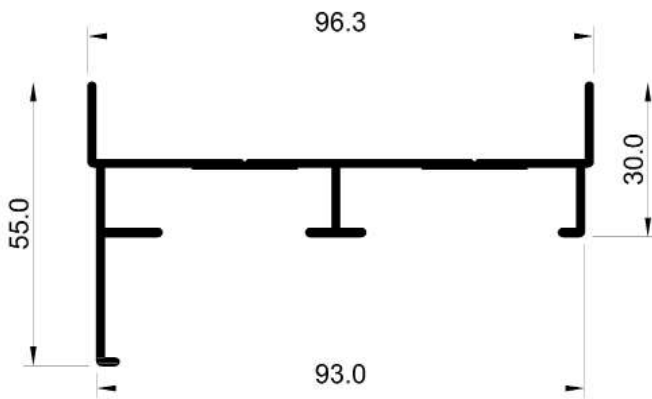

**10097**

Est Weight: 0.984 kg/m

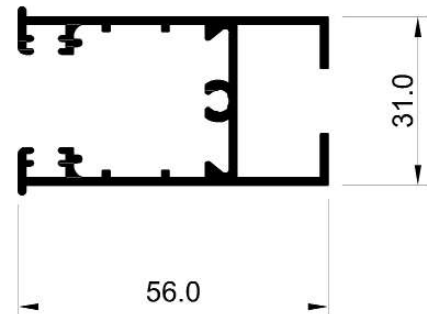

**10095**

Est Weight: 0.712 kg/m

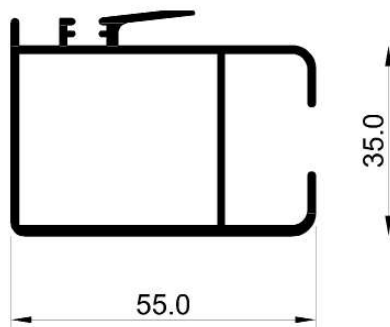

**20107**

Est Weight: 0.758 kg/m

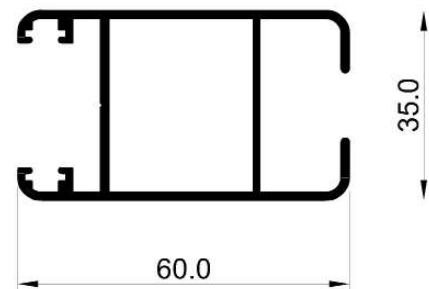

**20117**

Est Weight: 0.790 kg/m

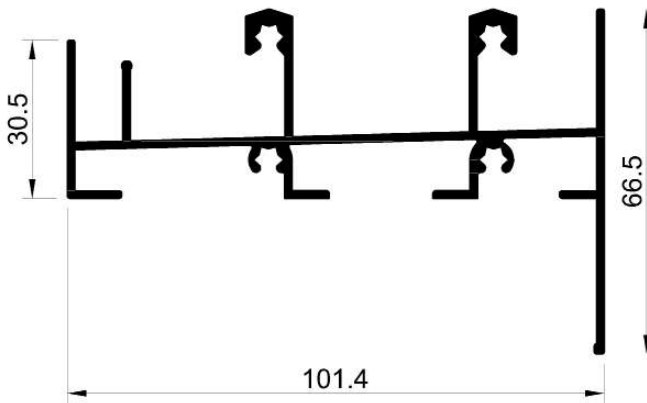

**10057**  
Est Weight: 1.560 kg/m

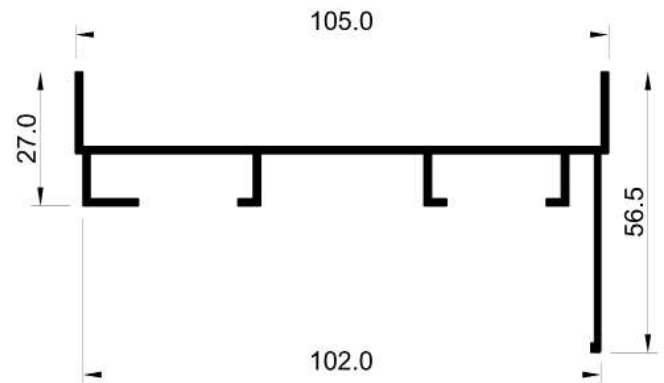

**10077**  
Est Weight: 0.936 kg/m

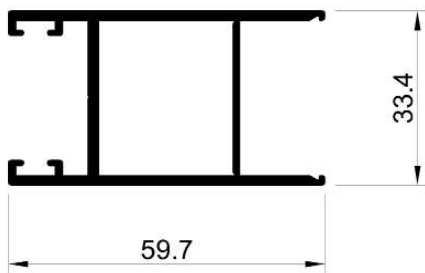

**20077**  
Est Weight: 0.889 kg/m

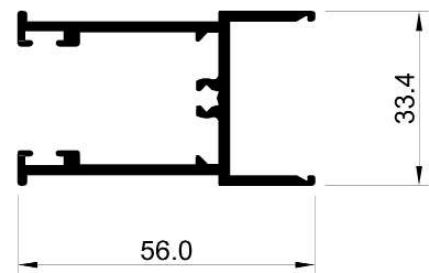

**10056**  
Est Weight: 0.856 kg/m

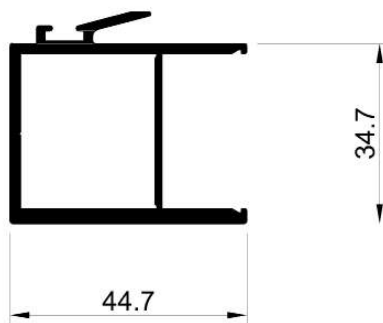

**20081**  
Est Weight: 0.935 kg/m

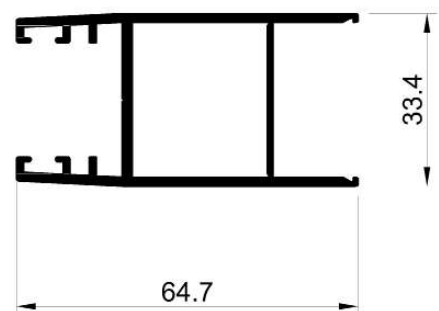

**20204**  
Est Weight: 0.972 kg/m



سالكو

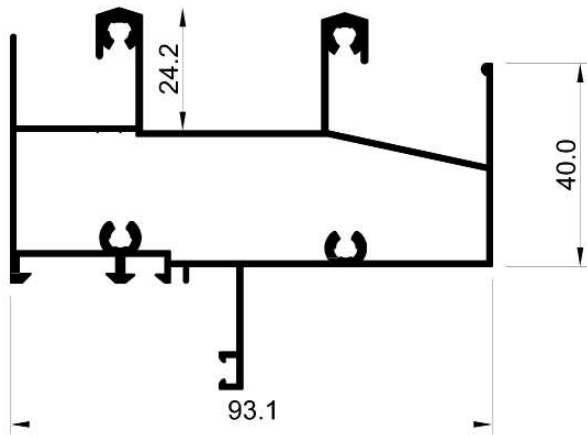

**20199**

Est Weight: 1.590 kg/m

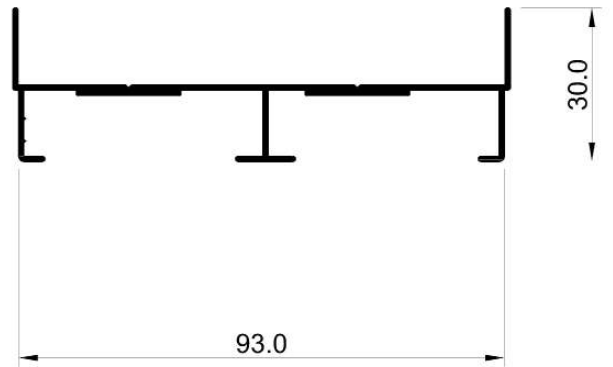

**10170**

Est Weight: 0.651 kg/m

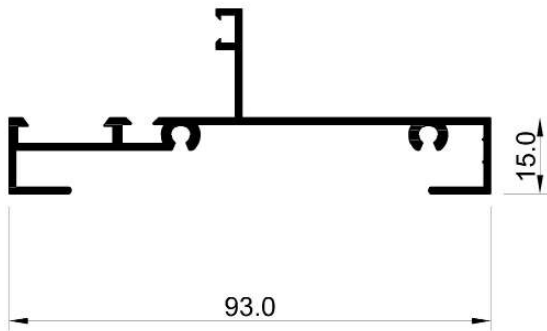

**10187**

Est Weight: 0.700 kg/m

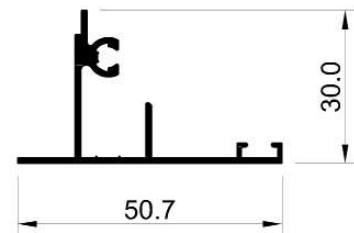

**10174**

Est Weight: 0.365 kg/m



**10172**

Est Weight: 1.500 kg/m

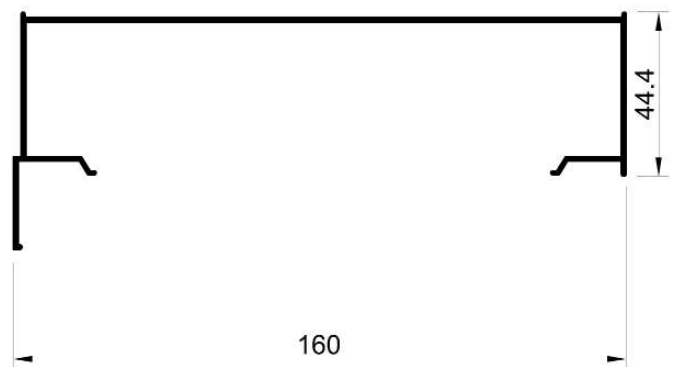

**10098**

Est Weight: 1.219 kg/m

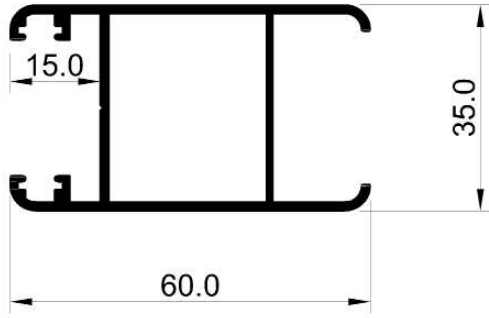

**20109**  
Est Weight: 0.758 kg/m



**20108**  
Est Weight: 0.835 kg/m

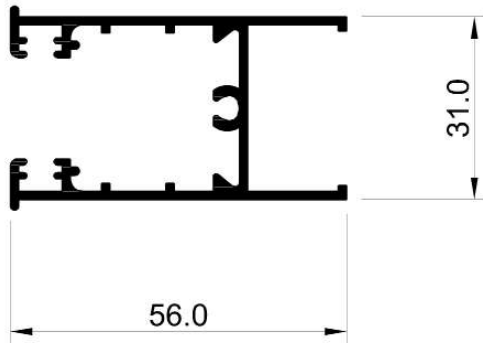

**10096**  
Est Weight: 0.758 kg/m



**20106**  
Est Weight: 0.432 kg/m

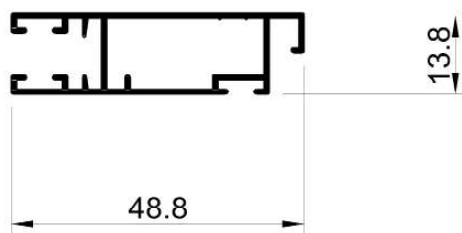

**20197**  
Est Weight: 0.375 kg/m

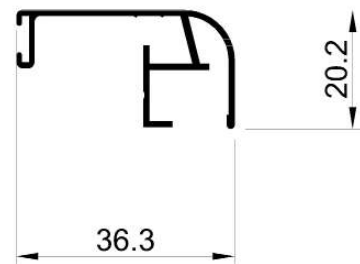

**10245**  
Est Weight: 0.290 kg/m

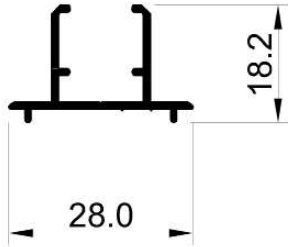

**10186**  
Est Weight: 0.196 kg/m

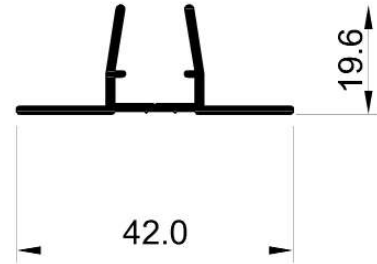

**10190**  
Est Weight: 0.263 kg/m

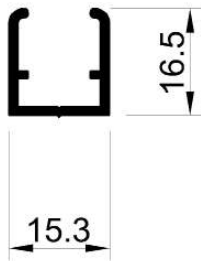

**10100**  
Est Weight: 0.197 kg/m

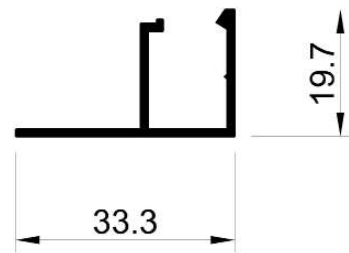

**10090**  
Est Weight: 0.257 kg/m

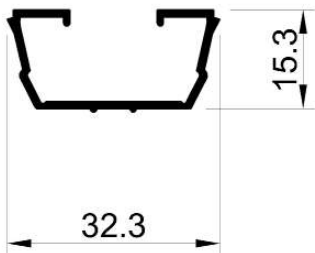

**10106**  
Est Weight: 0.217 kg/m

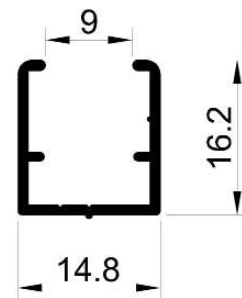

**10265**  
Est Weight: 0.135 kg/m

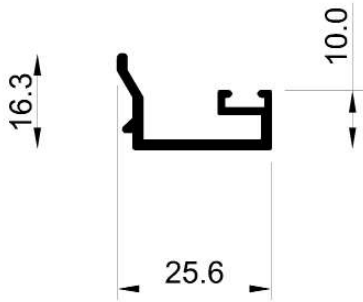

**10065**  
Est Weight: 0.219 kg/m

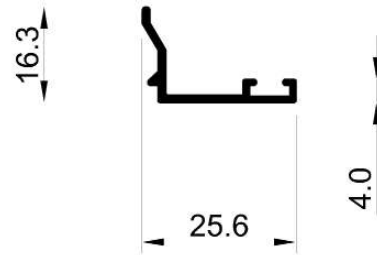

**10127**  
Est Weight: 0.158 kg/m

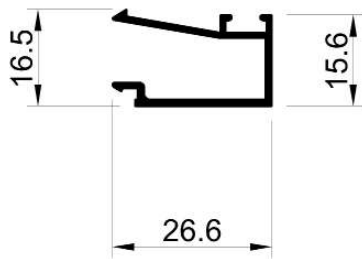

**10067**  
Est Weight: 0.233 kg/m

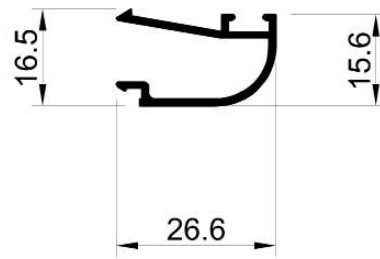

**10107**  
Est Weight: 0.220 kg/m

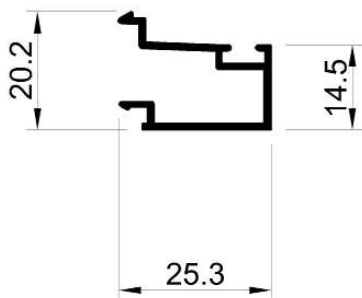

**10133**  
Est Weight: 0.264 kg/m

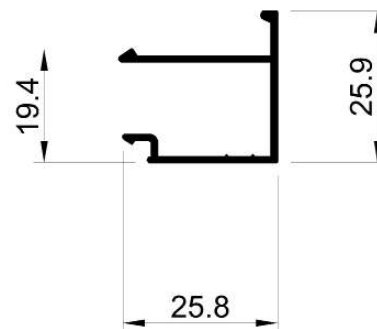

**10188**  
Est Weight: 0.287 kg/m

سالكو

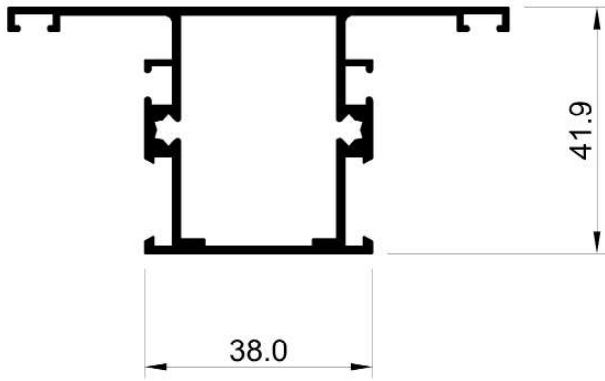

**20089**

Est Weight: 0.948 kg/m

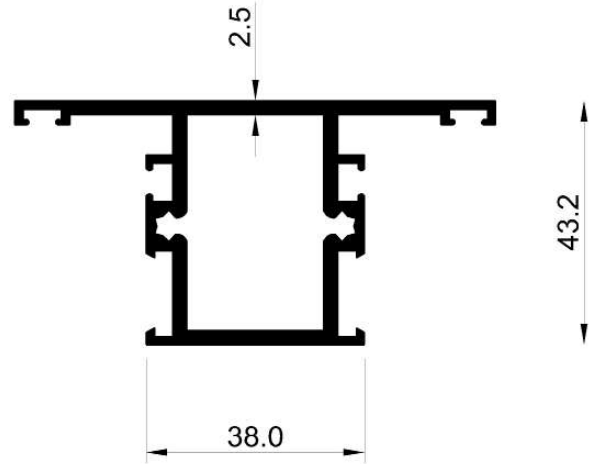

**20162**

Est Weight: 1.492 kg/m

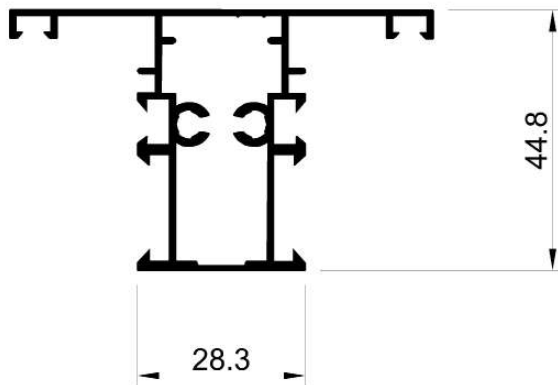

**20212**

Est Weight: 0.872 kg/m

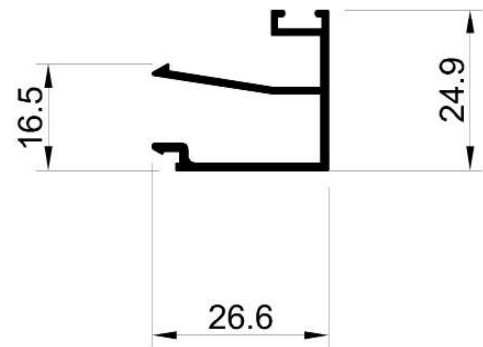

**10159**

Est Weight: 0.271 kg/m

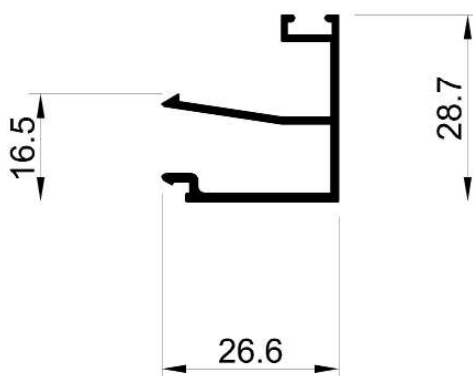

**10066**

Est Weight: 0.289 kg/m

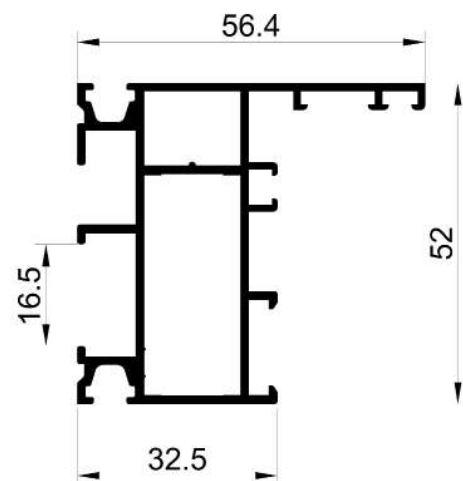

**20264**

Est Weight: 1.023 kg/m

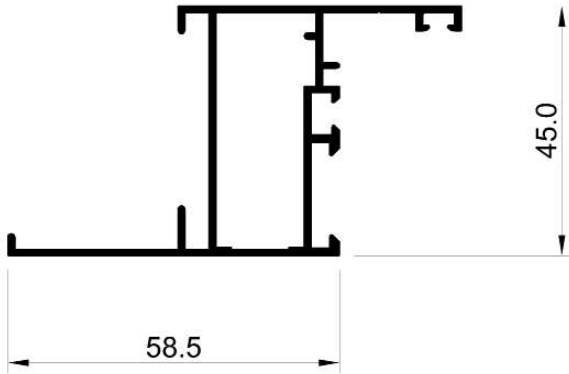

**20134**

**Est Weight: 0.900 kg/m**

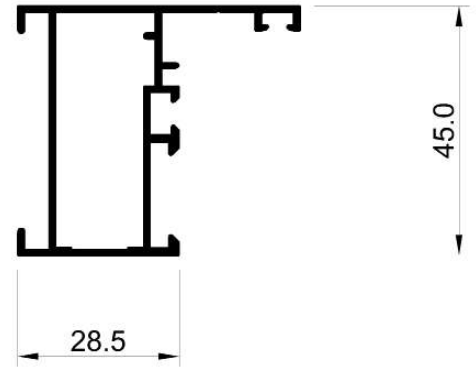

**20135**

**Est Weight: 0.707 kg/m**

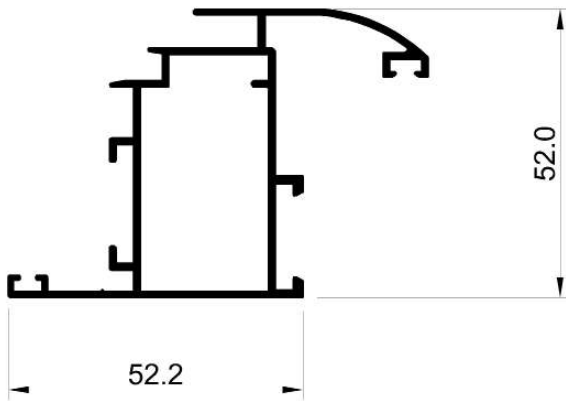

**20136**

**Est Weight: 0.863 kg/m**

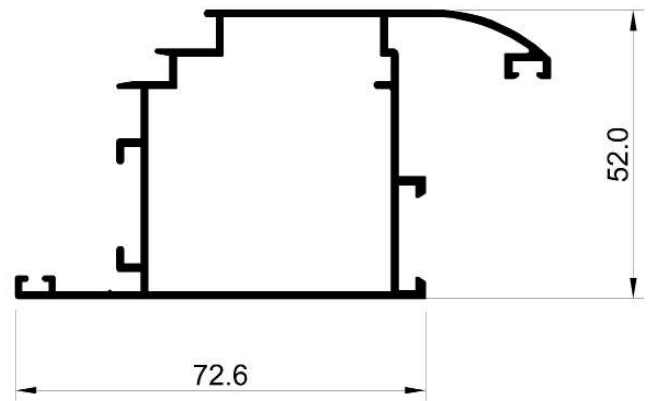

**20133**

**Est Weight: 1.180 kg/m**

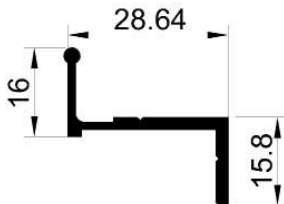

**10299**

**Est Weight: 0.314 kg/m**

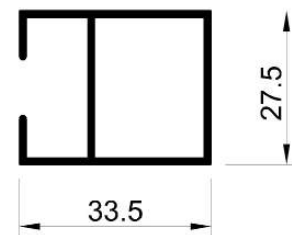

**20110**

**Est Weight: 0.370 kg/m**

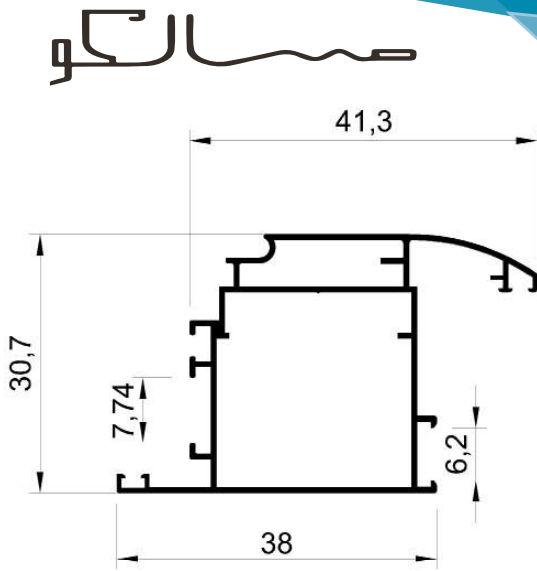

**20265**

**Est Weight: 1.406 kg/m**

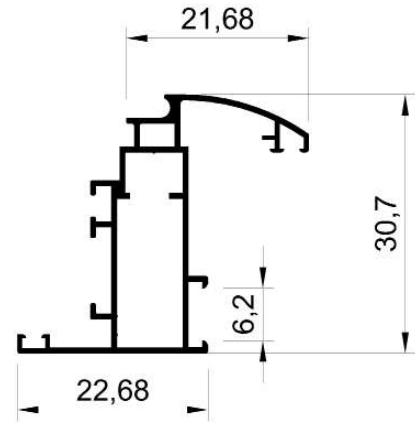

**20266**

**Est Weight: 1.056 kg/m**

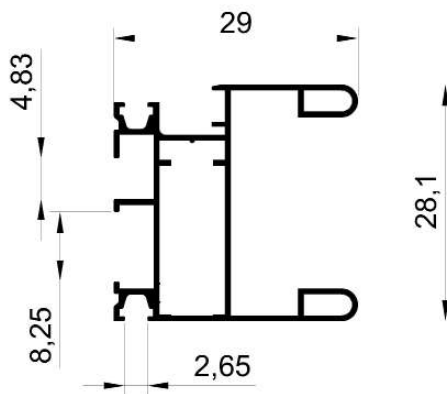

**20267**

**Est Weight: 1.175 kg/m**

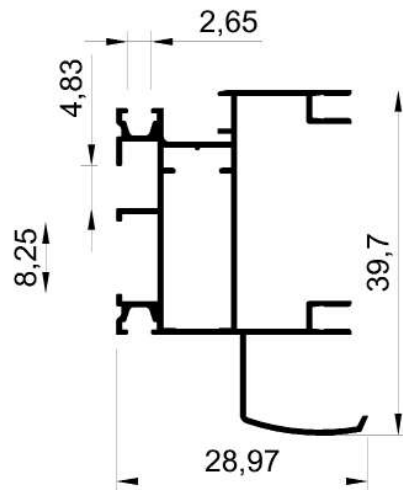

**20268**

**Est Weight: 1.250 kg/m**

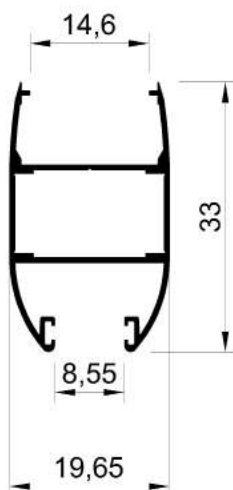

**20269**

**Est Weight: 0.940 kg/m**

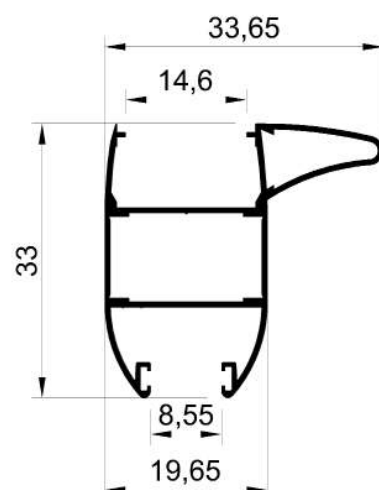

**20270**

**Est Weight: 1.197 kg/m**

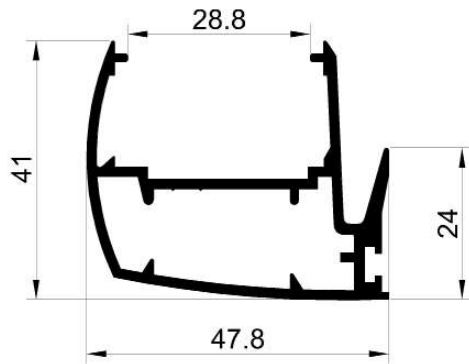

**20271**

**Est Weight: 0.836 kg/m**

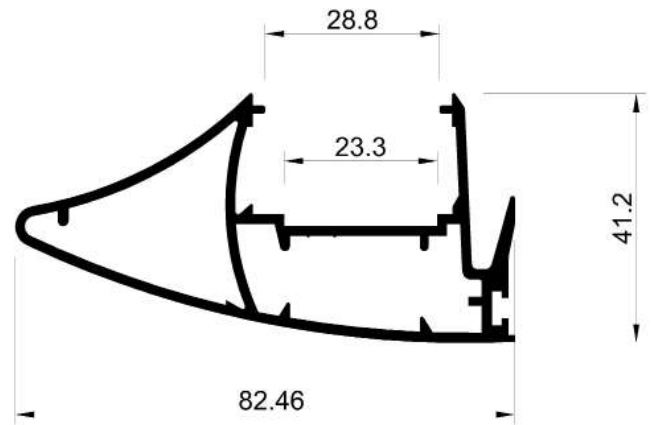

**20272**

**Est Weight: 1.306 kg/m**

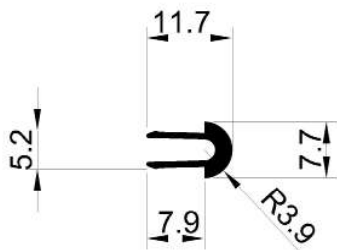

**10275**

**Est Weight: 0.110 kg/m**

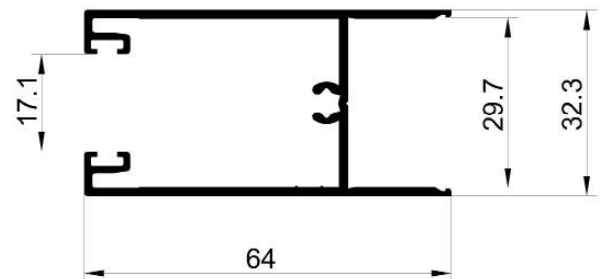

**10276**

**Est Weight: 0.775 kg/m**

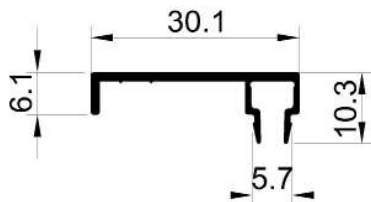

**10277**

**Est Weight: 0.180 kg/m**

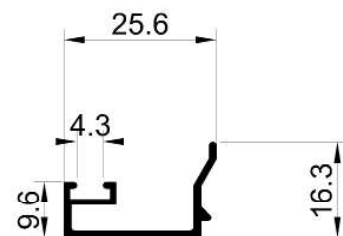

**10278**

**Est Weight: 0.210 kg/m**



سالكو

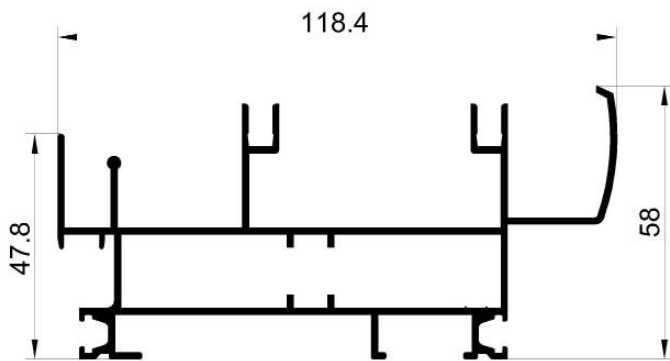

**20336**

Est Weight: 1.861 kg/m

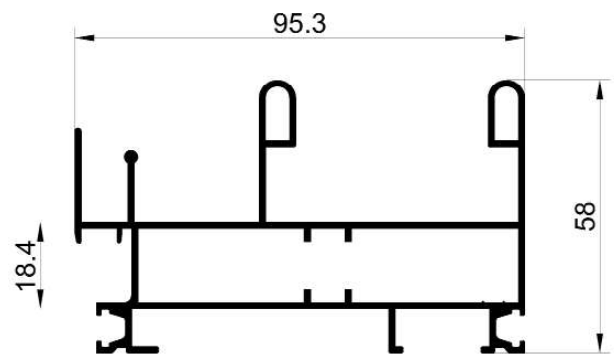

**20337**

Est Weight: 1.707 kg/m

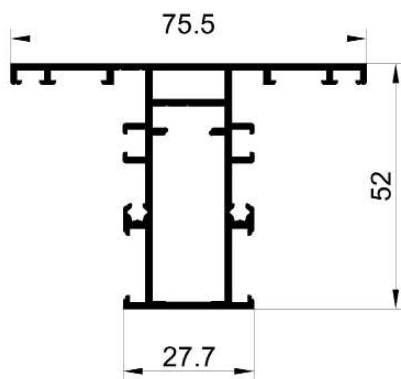

**20367**

Est Weight: 1.200 kg/m

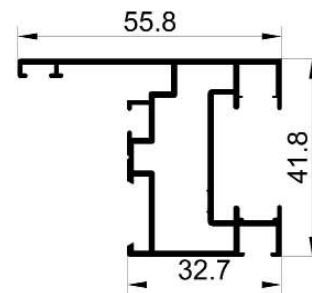

**20399**

Est Weight: 0.788 kg/m

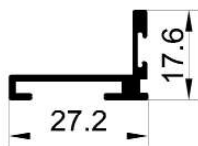

**10355**

Est Weight: 0.244 kg/m

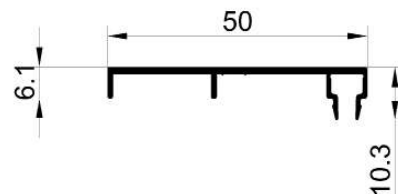

**10381**

Est Weight: 0.252 kg/m

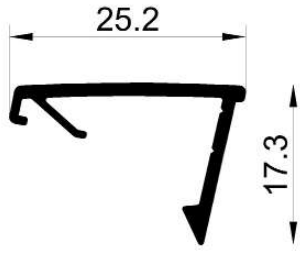

**10380**

**Est Weight: 0.180 kg/m**



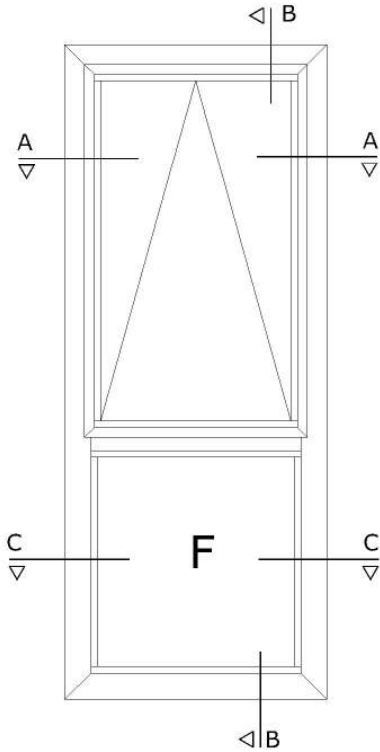

### نموذج دبل ومفصلات ثابتة

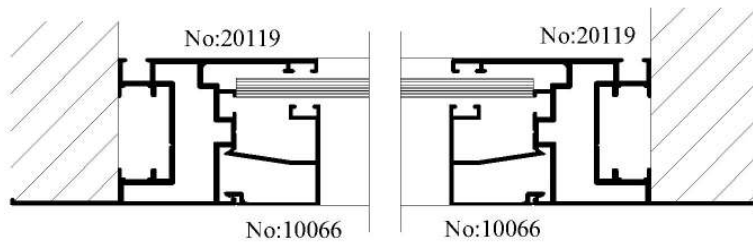

Section C-C

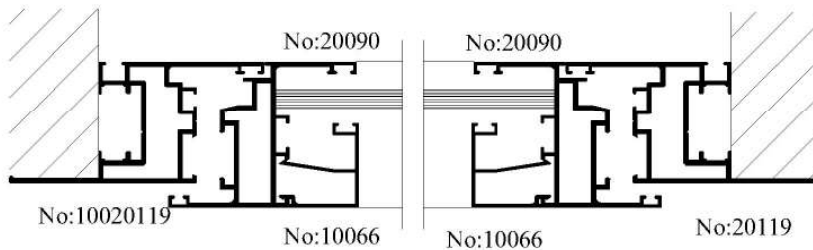

Section A-A

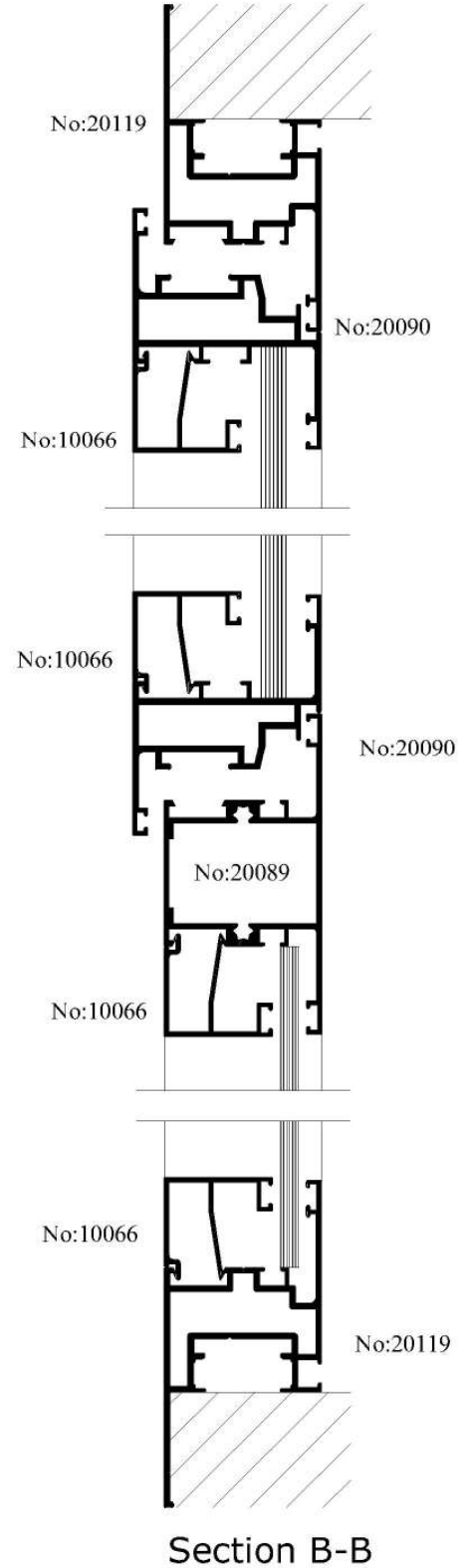

Section B-B

سالكو

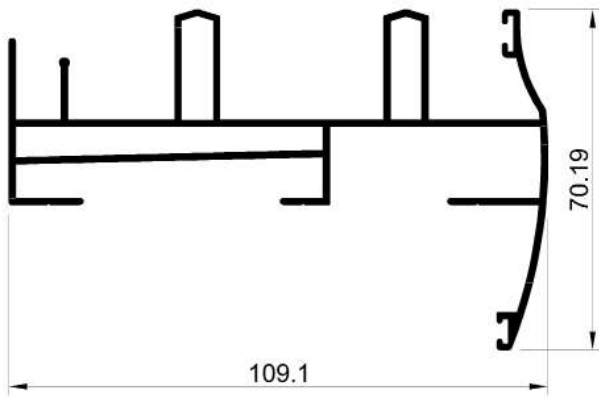

**20141**  
Est Weight: 1.620 kg/m

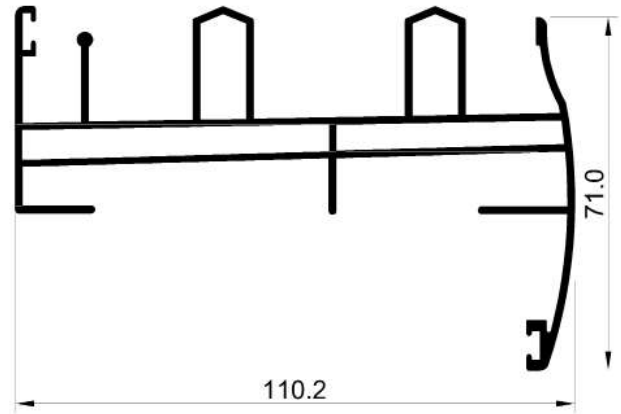

**20215**  
Est Weight: 1.907 kg/m

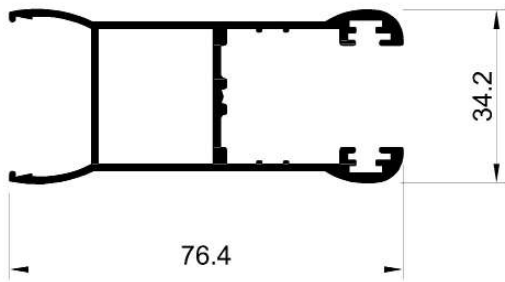

**20144**  
Est Weight: 1.033 kg/m

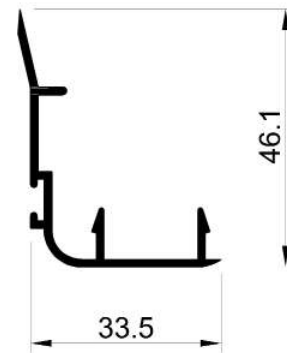

**10143**  
Est Weight: 0.386 kg/m

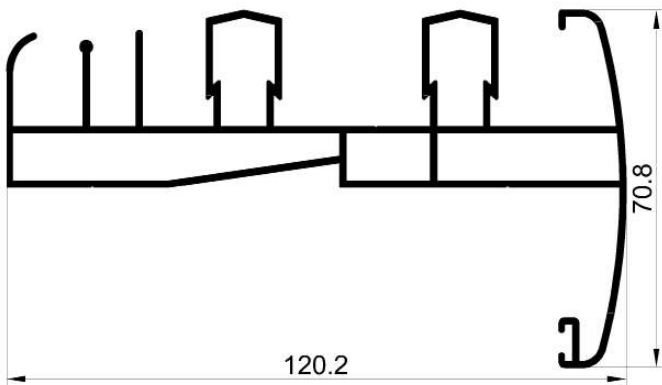

**20155**  
Est Weight: 1.794 kg/m

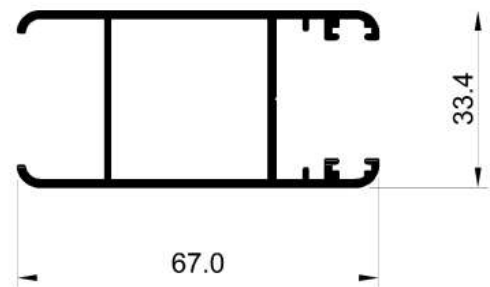

**20157**  
Est Weight: 0.850 kg/m

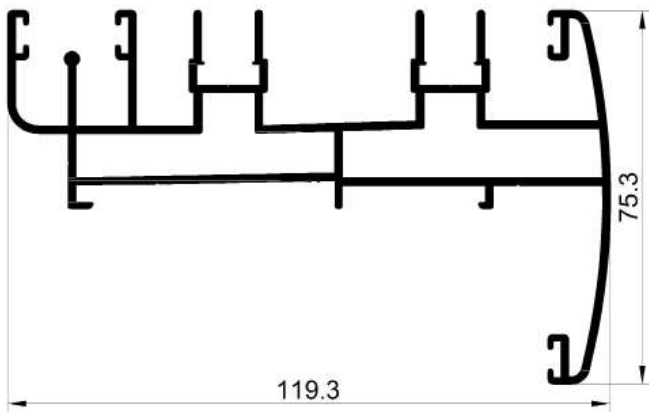

**20166**  
Est Weight: 2.200 kg/m

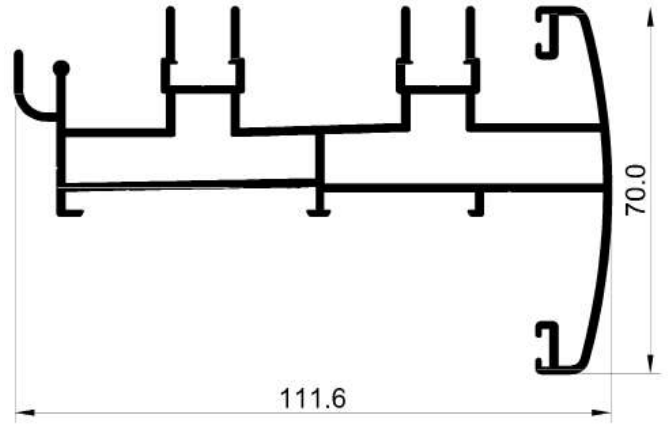

**20154**  
Est Weight: 1.943 kg/m

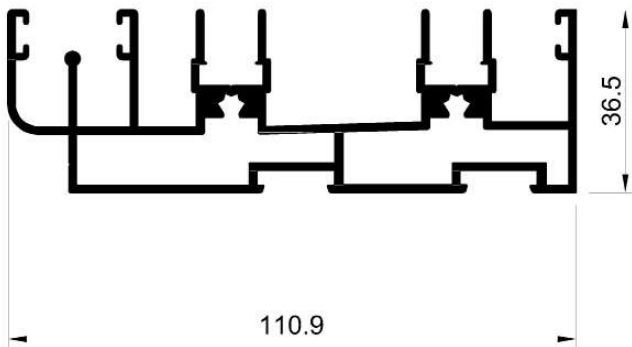

**20182**  
Est Weight: 2.070 kg/m

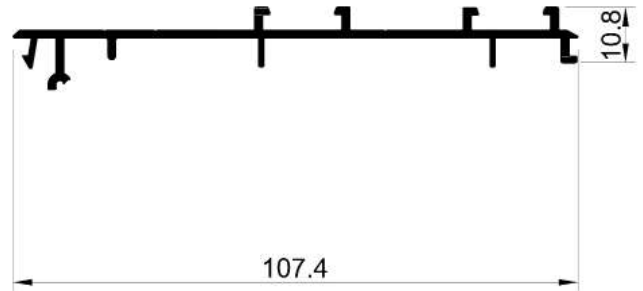

**10166**  
Est Weight: 0.661 kg/m

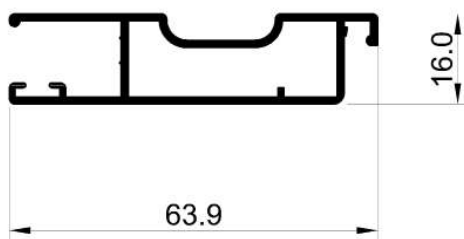

**20213**  
Est Weight: 0.583 kg/m

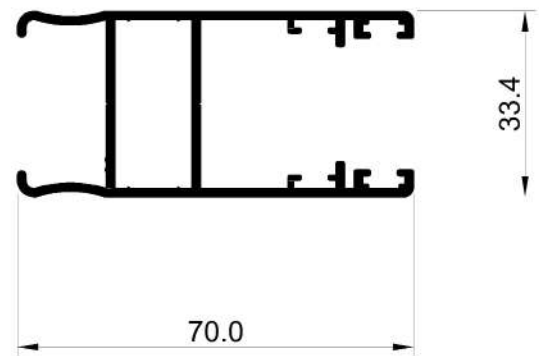

**20153**  
Est Weight: 0.880 kg/m

سالكو

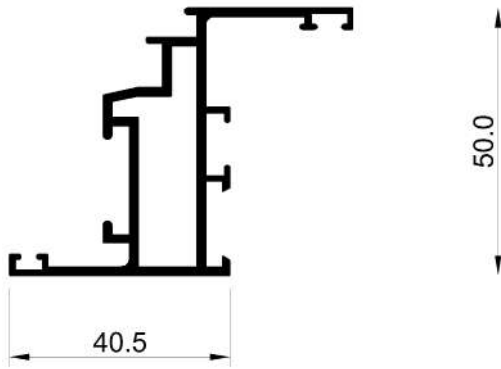

**20090**

Est Weight: 0.890 kg/m

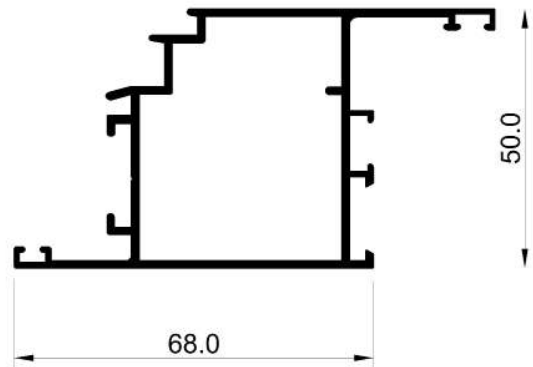

**20085**

Est Weight: 1.080 kg/m

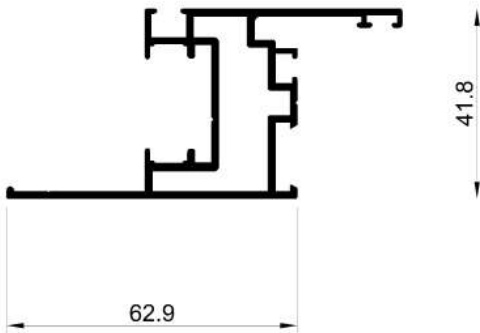

**20119**

Est Weight: 1.052 kg/m

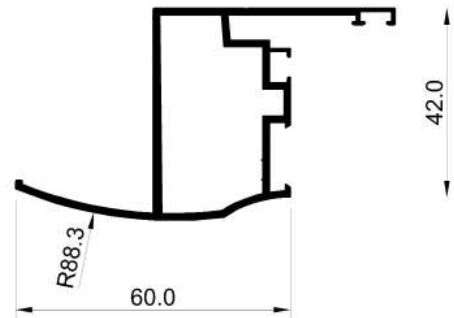

**20174**

Est Weight: 0.908 kg/m

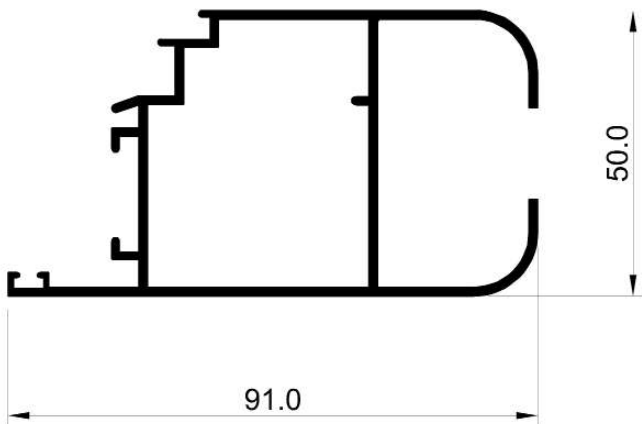

**20086**

Est Weight: 1.221 kg/m

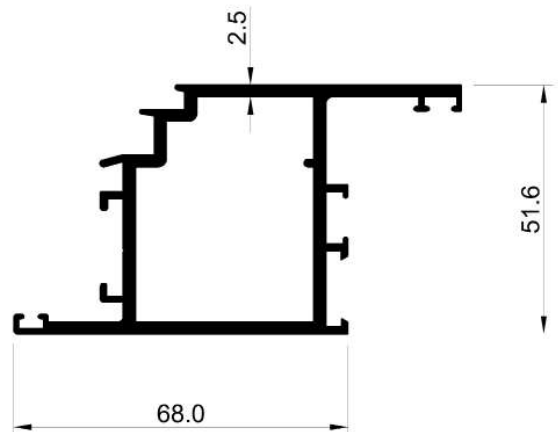

**20161**

Est Weight: 1.708 kg/m

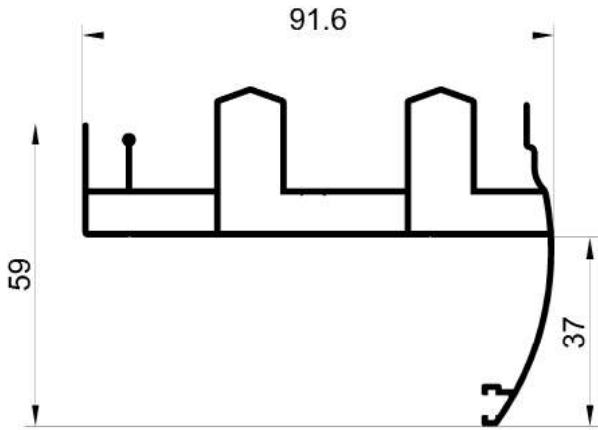

**20334**

**Est Weight: 1.222 kg/m**

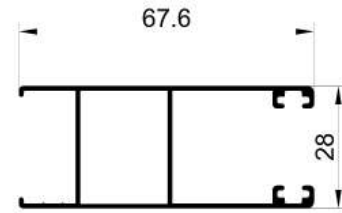

**20335**

**Est Weight: 0.627 kg/m**

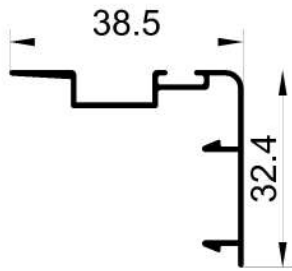

**10328**

**Est Weight: 0.252 kg/m**



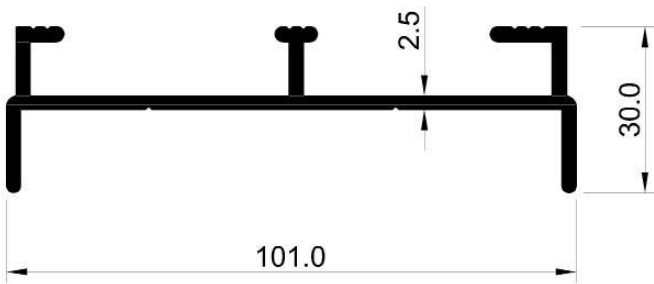

**10157**  
Est Weight: 1.270 kg/m

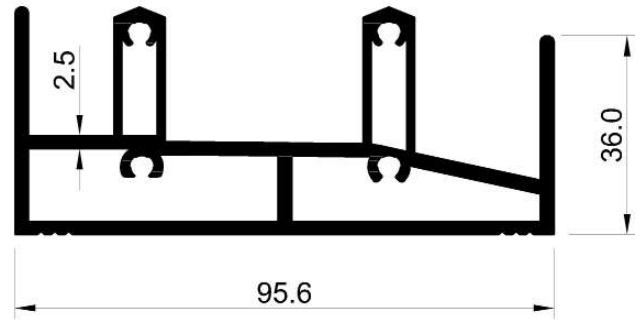

**20164**  
Est Weight: 2.404 kg/m

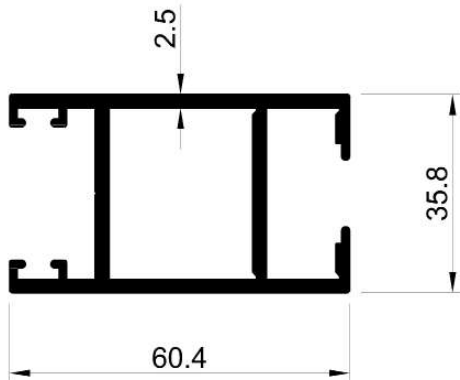

**20158**  
Est Weight: 1.404 kg/m

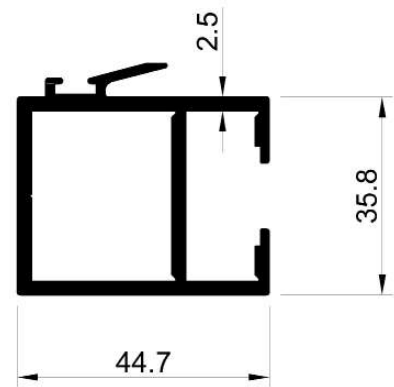

**20159**  
Est Weight: 1.216 kg/m

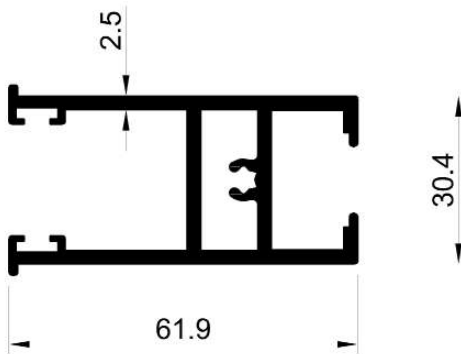

**20160**  
Est Weight: 1.364 kg/m

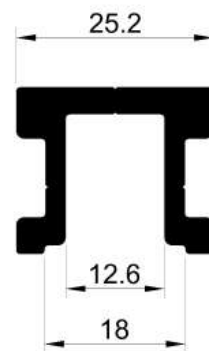

**10271**  
Est Weight: 0.623 kg/m

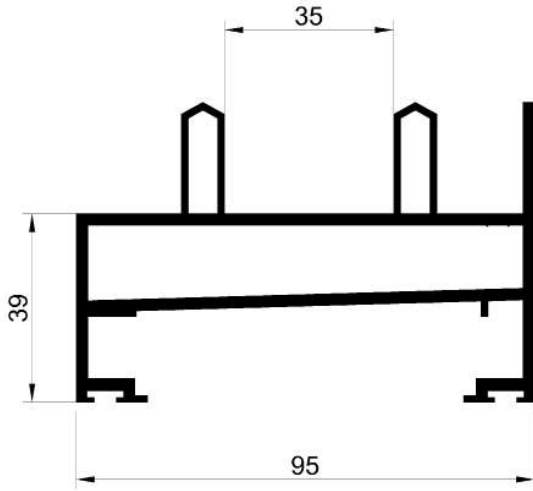

**20286**

Est Weight: 3.000 kg/m

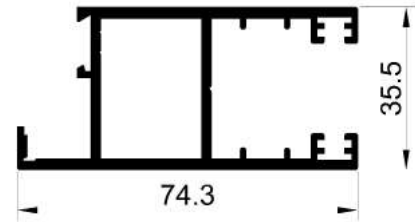

**20287**

Est Weight: 1.500 kg/m

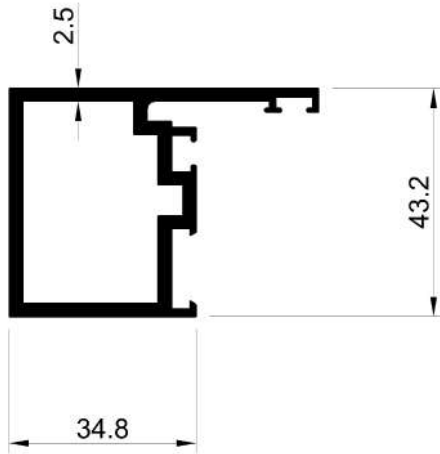

**20163**

Est Weight: 1.410 kg/m

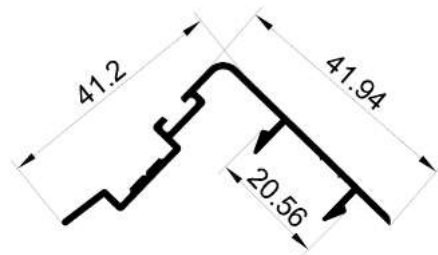

**10298**

Est Weight: 0.376 kg/m

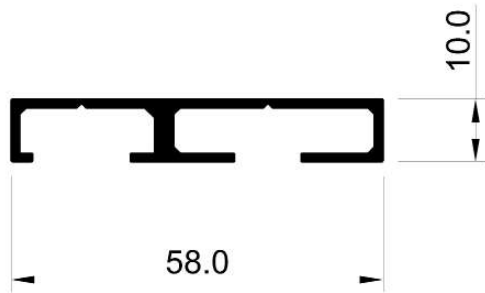

**10153**  
Est Weight: 0.462 kg/m

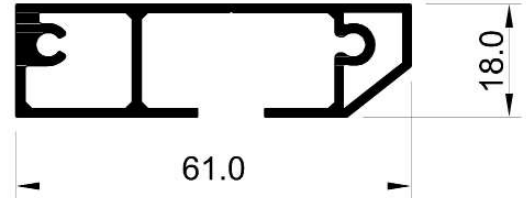

**20156**  
Est Weight: 0.764 kg/m

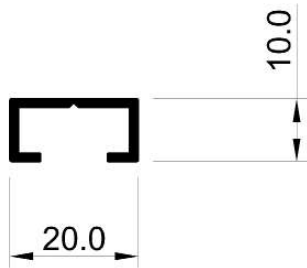

**10154**  
Est Weight: 0.164 kg/m

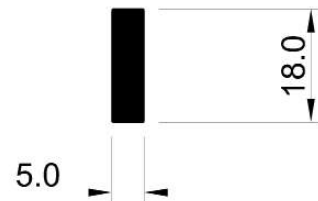

**10155**  
Est Weight: 0.243 kg/m

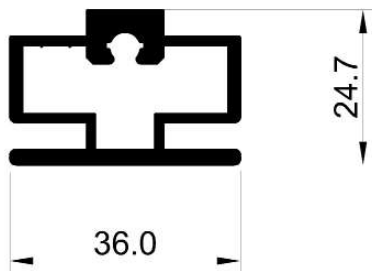

**20173**  
Est Weight: 0.817 kg/m

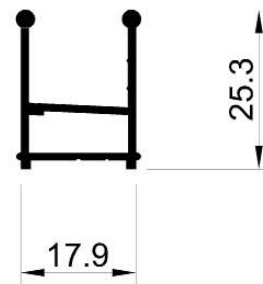

**20239**  
Est Weight: 0.305 kg/m

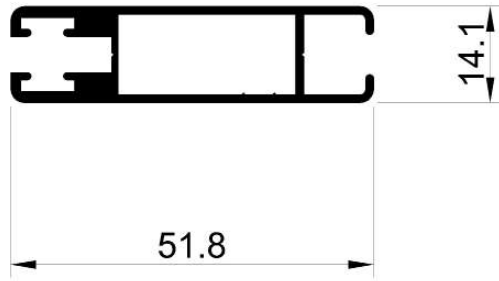

**20238**  
Est Weight: 0.610 kg/m

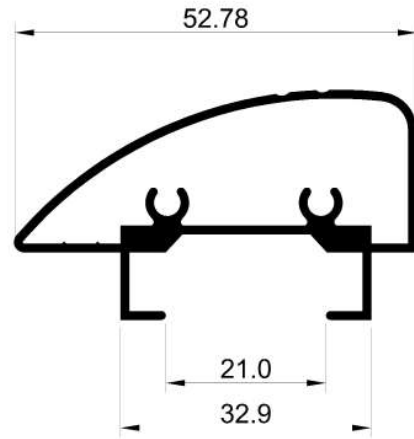

**20256**  
Est Weight: 0.644 kg/m

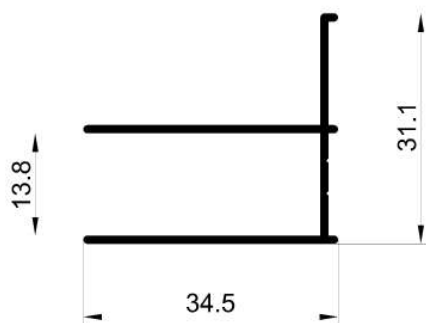

**10315**  
Est Weight: 0.292 kg/m

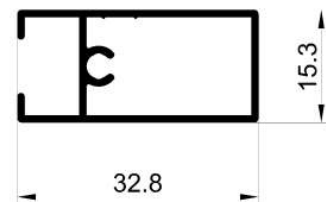

**20317**  
Est Weight: 0.290 kg/m

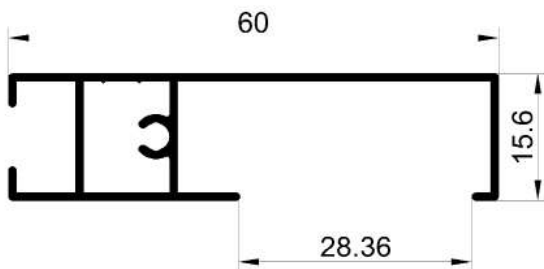

**20318**  
Est Weight: 0.401 kg/m

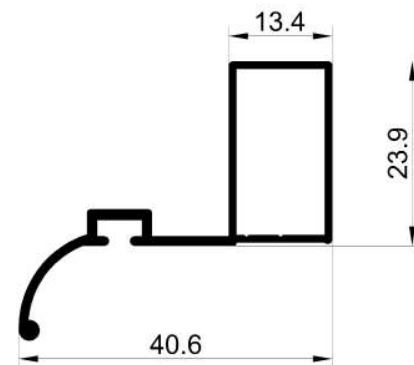

**20319**  
Est Weight: 0.350 kg/m

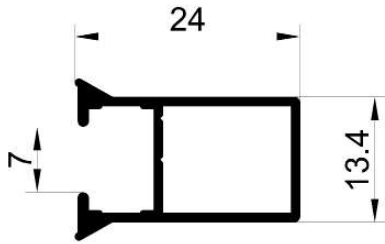

**20320**  
Est Weight: 0.230 kg/m

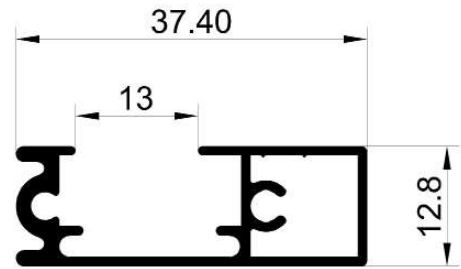

**20321**  
Est Weight: 0.347 kg/m

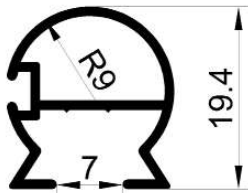

**20322**  
Est Weight: 0.208 kg/m

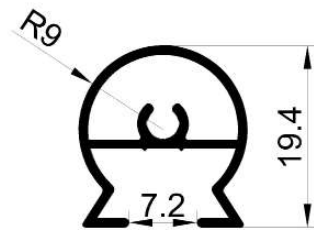

**20323**  
Est Weight: 0.222 kg/m

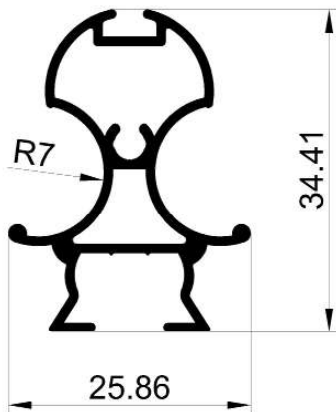

**20324**  
Est Weight: 0.398 kg/m

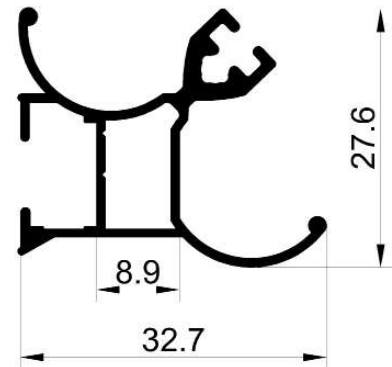

**20325**  
Est Weight: 0.390 kg/m

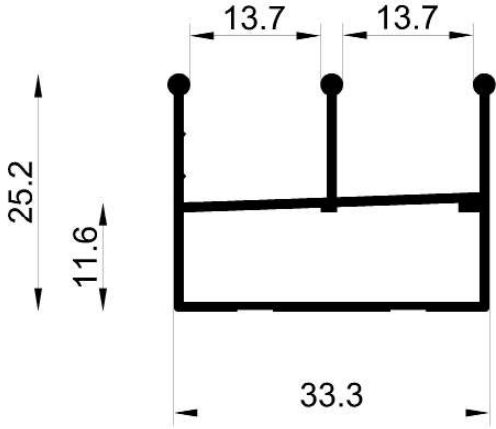

**20309**

**Est Weight: 0.382 kg/m**

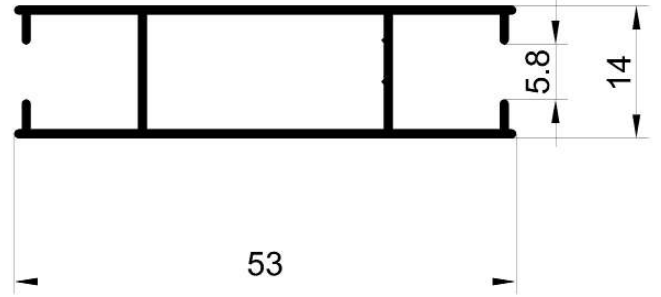

**20310**

**Est Weight: 0.365 kg/m**

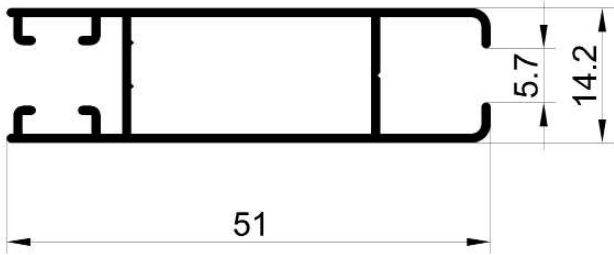

**20311**

**Est Weight: 0.379 kg/m**

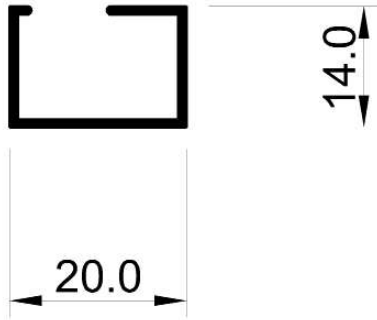

**10030**  
Est Weight: 0.151 kg/m

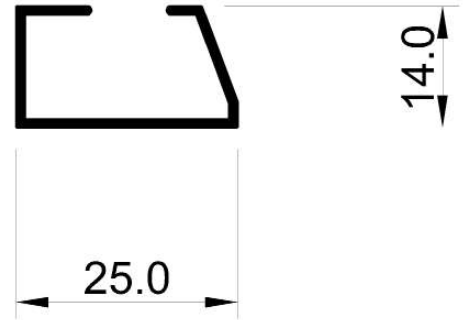

**10031**  
Est Weight: 0.176 kg/m



**10042**  
Est Weight: 0.152 kg/m

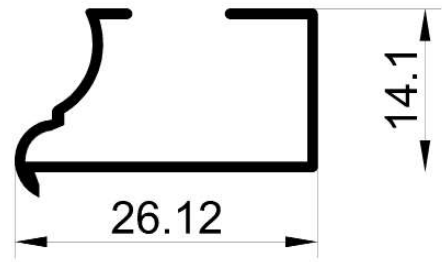

**10322**  
Est Weight: 0.166 kg/m

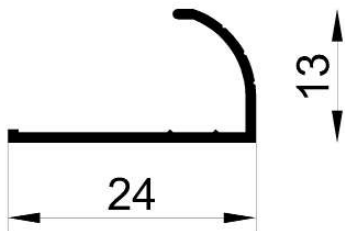

**10354**  
Est Weight: 0.207 kg/m

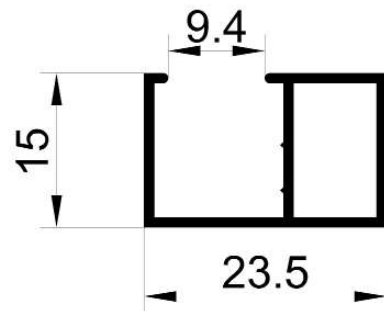

**20358**  
Est Weight: 0.107 kg/m

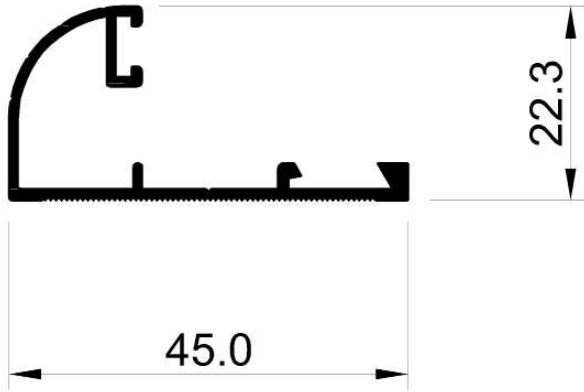

**10125**

Est Weight: 0.265 kg/m

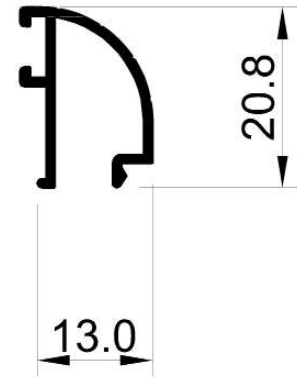

**10126**

Est Weight: 0.153 kg/m



**10117**

Est Weight: 0.237 kg/m

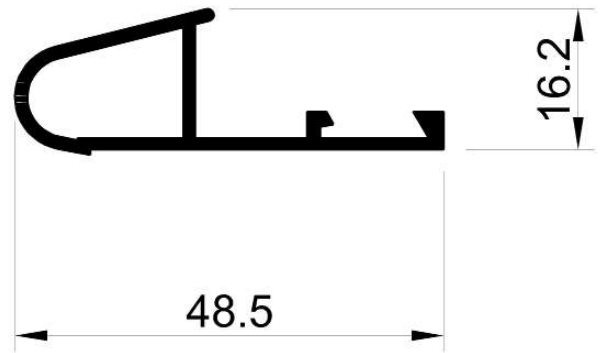

**20165**

Est Weight: 0.376 kg/m



**10050**

Est Weight: 0.240 kg/m

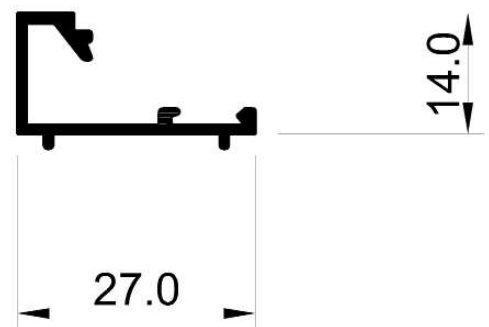

**10149**

Est Weight: 0.189 kg/m



سالكو

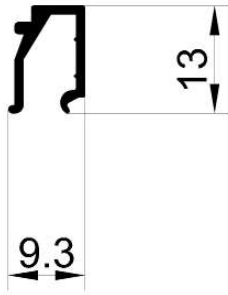

**10150**

**Est Weight: 0.102 kg/m**

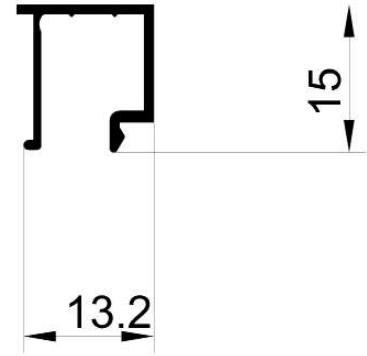

**10049**

**Est Weight: 0.120 kg/m**

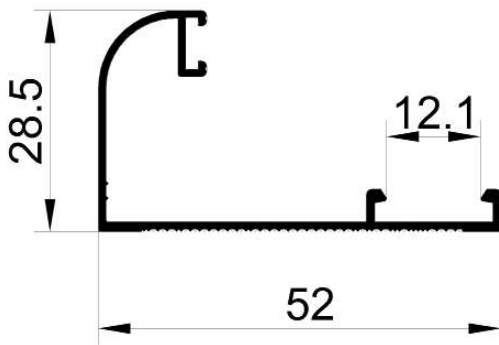

**10385**

**Est Weight: 0.325 kg/m**

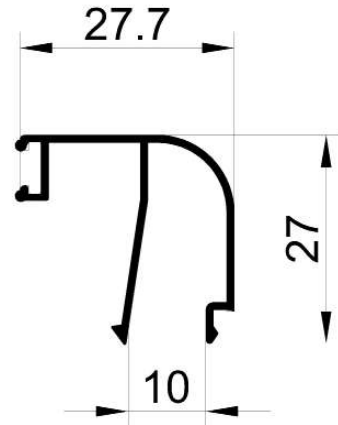

**10386**

**Est Weight: 0.249 kg/m**



**20111**  
Est Weight: 0.585 kg/m

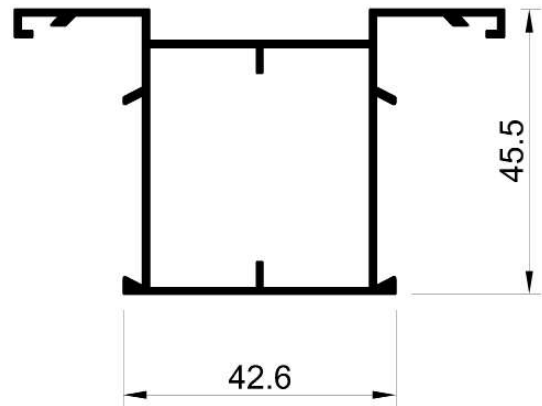

**20112**  
Est Weight: 0.727 kg/m

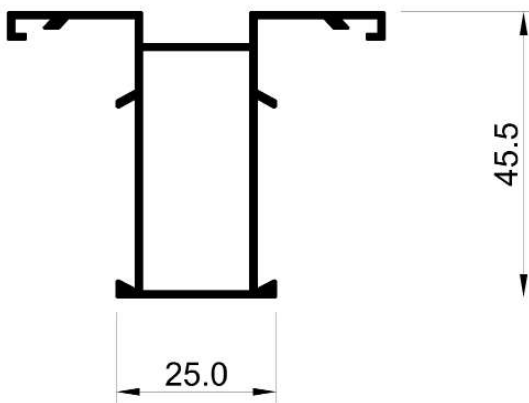

**20113**  
Est Weight: 0.600 kg/m

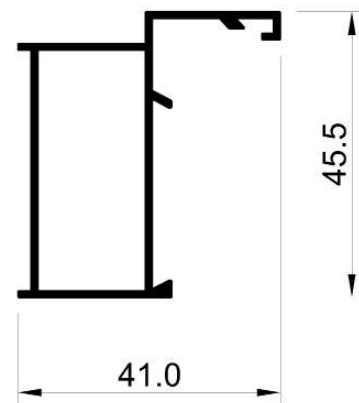

**20114**  
Est Weight: 0.482 kg/m

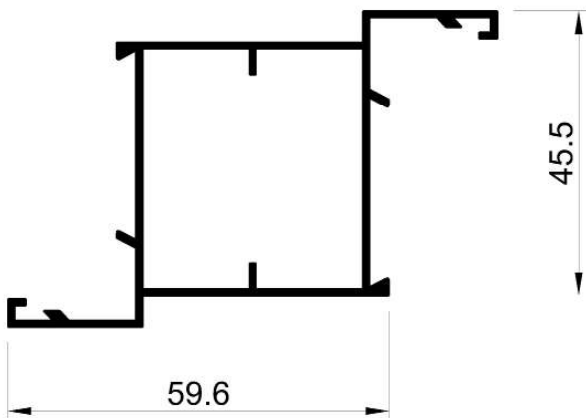

**20115**  
Est Weight: 0.727 kg/m

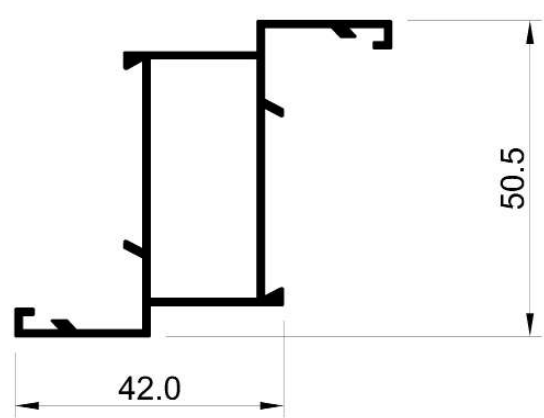

**20116**  
Est Weight: 0.600 kg/m

سالكو



**10036**

Est Weight: 0.226 kg/m

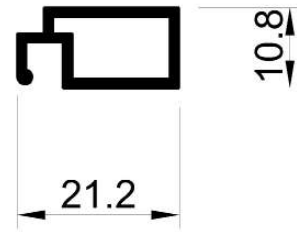

**20047**

Est Weight: 0.214 kg/m

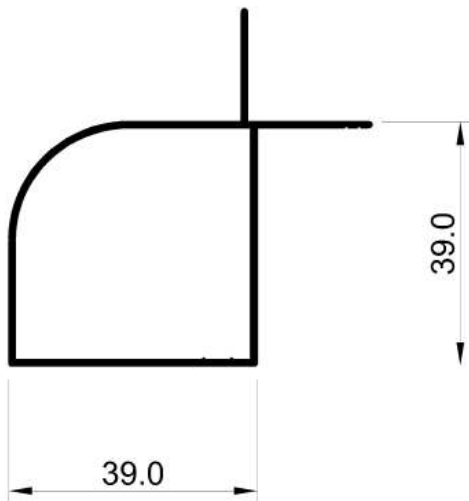

**20167**

Est Weight: 0.487 kg/m

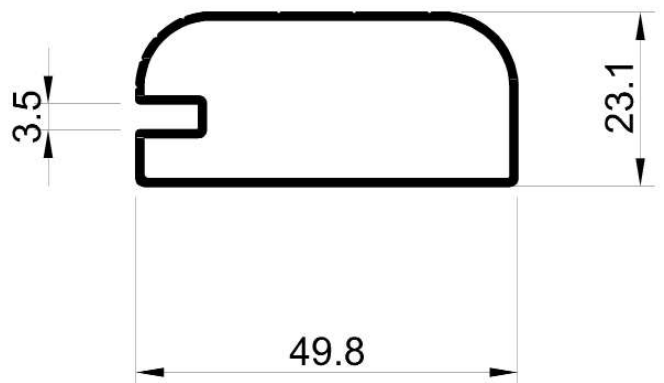

**20060**

Est Weight: 0.401 kg/m

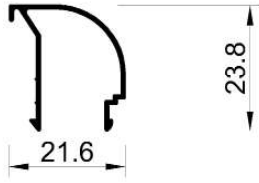

**10234**

Est Weight: 0.184 kg/m

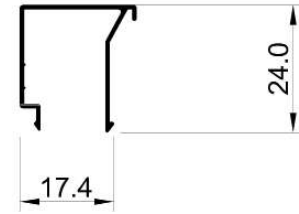

**10235**

Est Weight: 0.161 kg/m

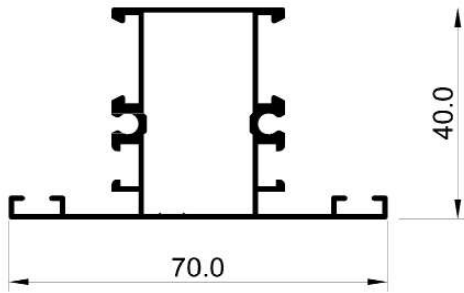

**20231**

Est Weight: 0.701 kg/m

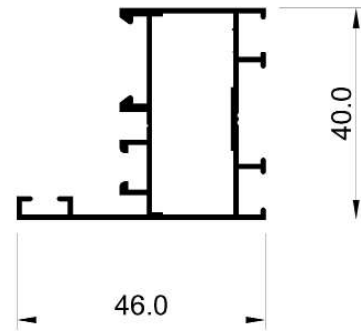

**20232**

Est Weight: 0.559 kg/m



**20233**

Est Weight: 0.538 kg/m

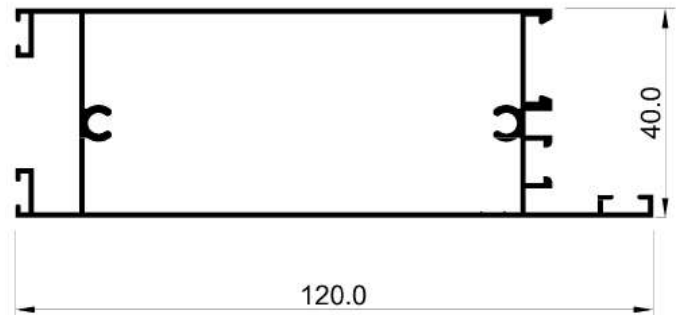

**20234**

Est Weight: 0.984 kg/m

سالكو

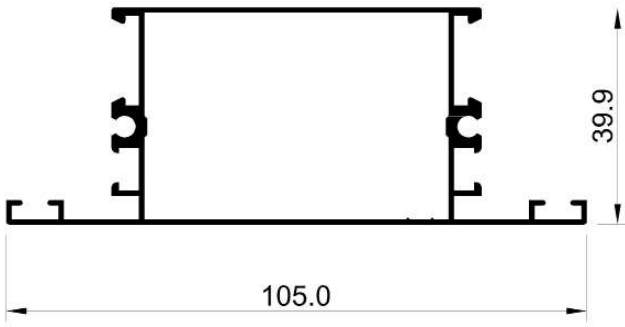

**20235**

**Est Weight: 0.919 kg/m**

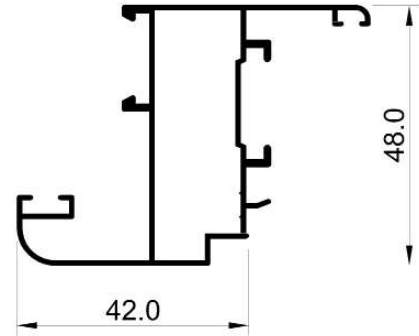

**20236**

**Est Weight: 0.661 kg/m**

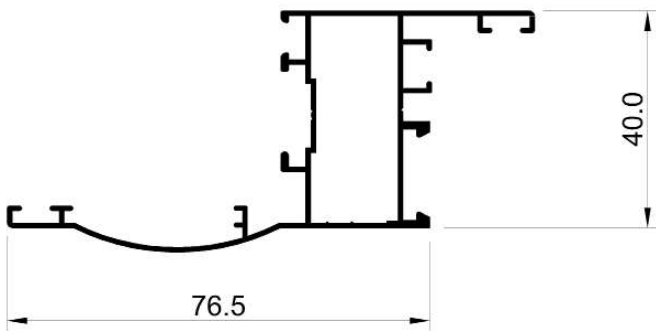

**20237**

**Est Weight: 0.708 kg/m**

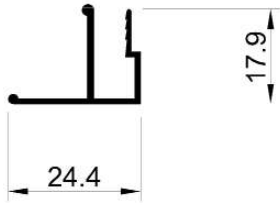

**10225**  
Est Weight: 0.188 kg/m

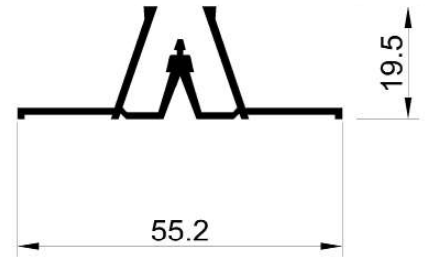

**10227**  
Est Weight: 0.404 kg/m

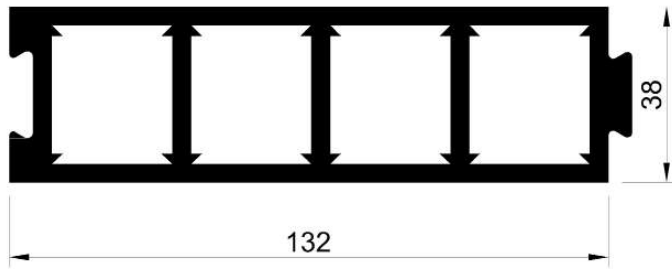

**20230**  
Est Weight: 4.890 kg/m

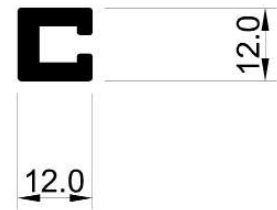

**10236**  
Est Weight: 0.271 kg/m



**20260**  
Est Weight: 1.446 kg/m

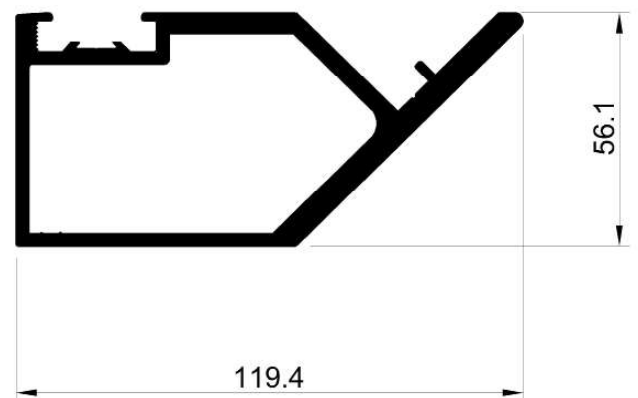

**20168**  
Est Weight: 3.450 kg/m

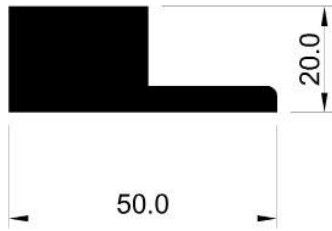

**10232**  
Est Weight: 1.732 kg/m



**10233**  
Est Weight: 2.335 kg/m

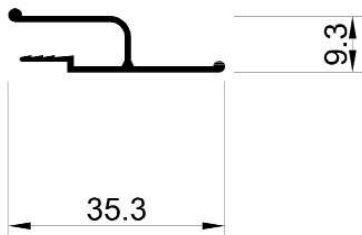

**10226**  
Est Weight: 0.172 kg/m

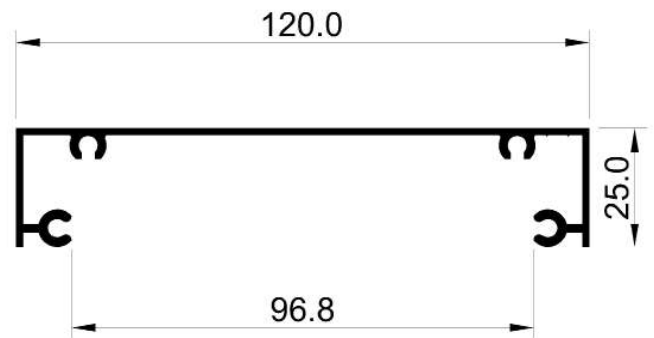

**10266**  
Est Weight: 0.962 kg/m

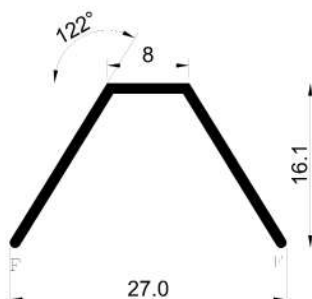

**10267**  
Est Weight: 0.124 kg/m

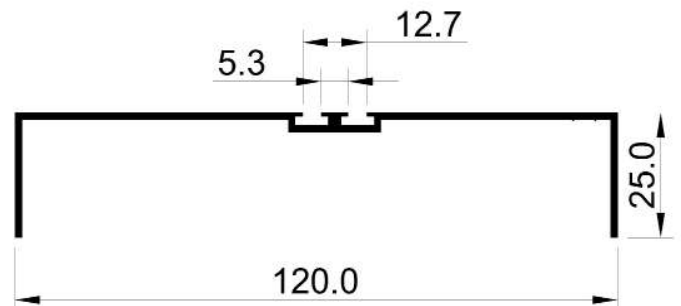

**10268**  
Est Weight: 0.702 kg/m

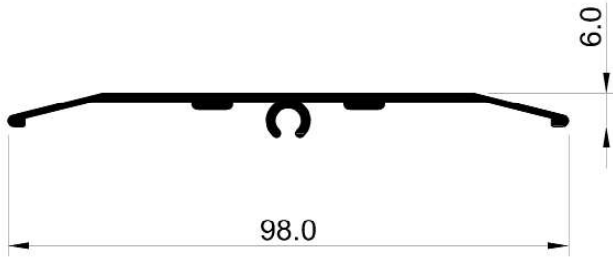

**10156**  
Est Weight: 0.483 kg/m

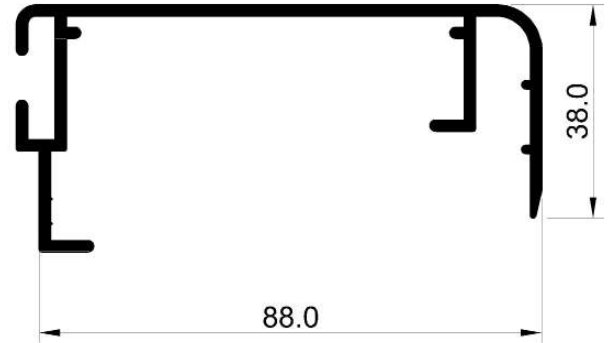

**10162**  
Est Weight: 1.220 kg/m

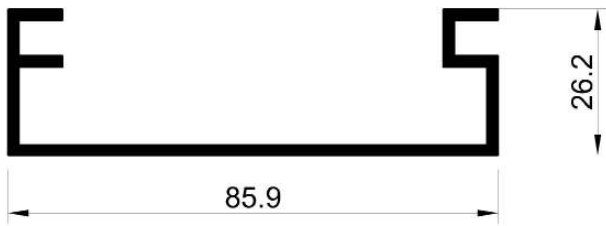

**10175**  
Est Weight: 1.663 kg/m

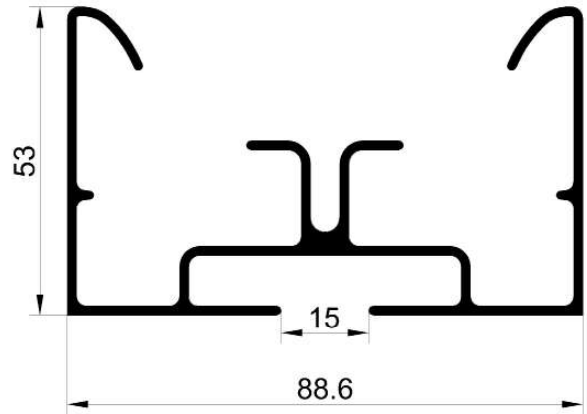

**10382**  
Est Weight: 1.482 kg/m

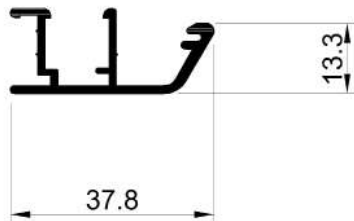

**10193**  
Est Weight: 0.354 kg/m

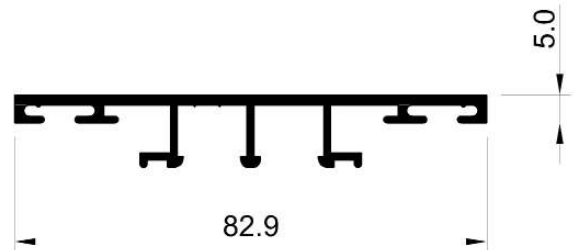

**10194**  
Est Weight: 0.703 kg/m



سلك

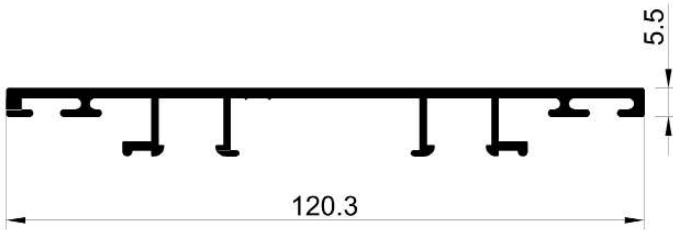

**10195**  
Est Weight: 0.963 kg/m

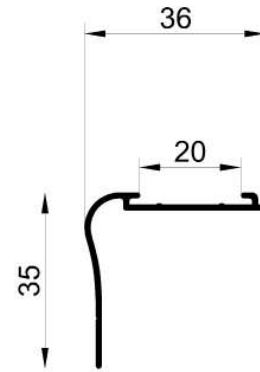

**10054**  
Est Weight: 0.246 kg/m

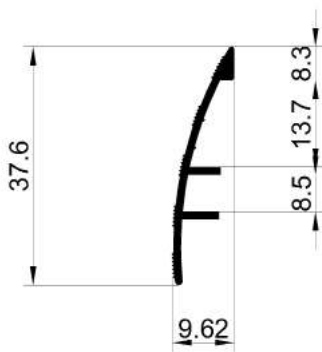

**10069**  
Est Weight: 0.180 kg/m

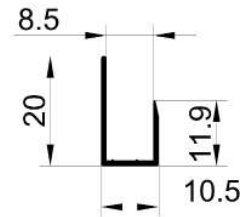

**10070**  
Est Weight: 0.100 kg/m

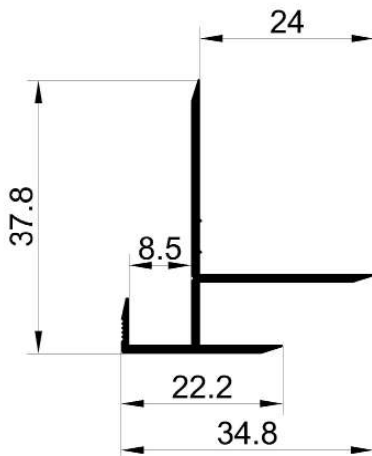

**10071**  
Est Weight: 0.270 kg/m

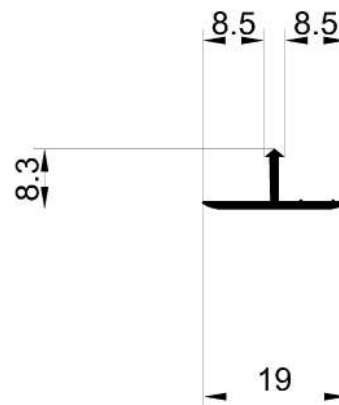

**10072**  
Est Weight: 0.080 kg/m

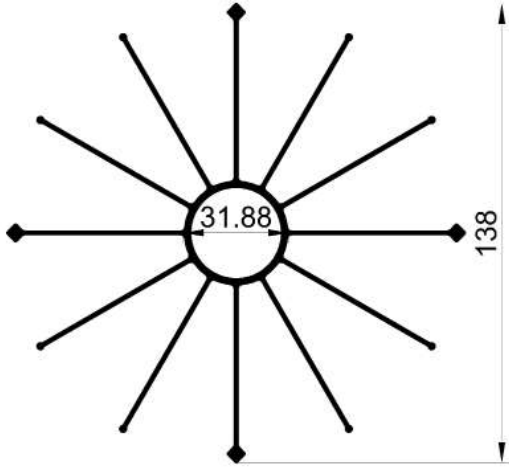

**20351**

Est Weight: 3.303 kg/m

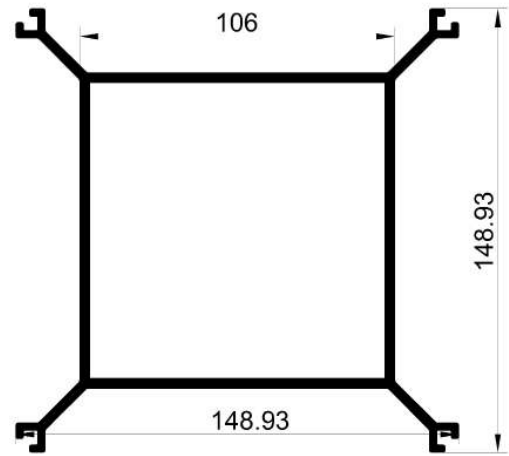

**20350**

Est Weight: 5.230 kg/m

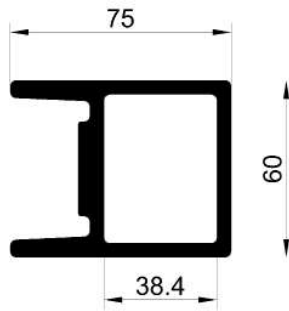

**20374**

Est Weight: 3.859 kg/m

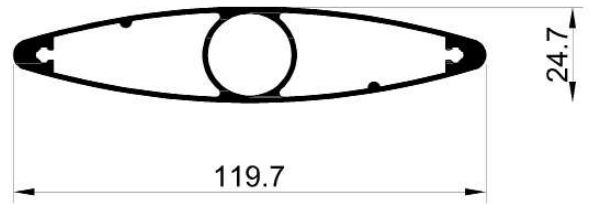

**20205**

Est Weight: 1.282 kg/m

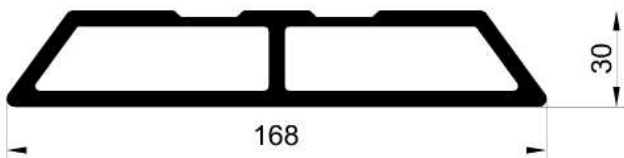

**20376**

Est Weight: 4.800 kg/m

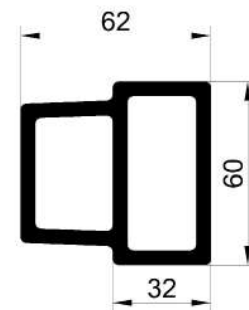

**20375**

Est Weight: 3.398 kg/m

سالكو

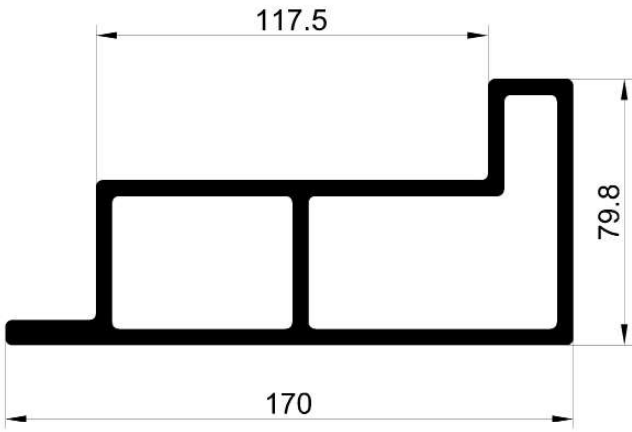

**20377**  
Est Weight: 6.625 kg/m

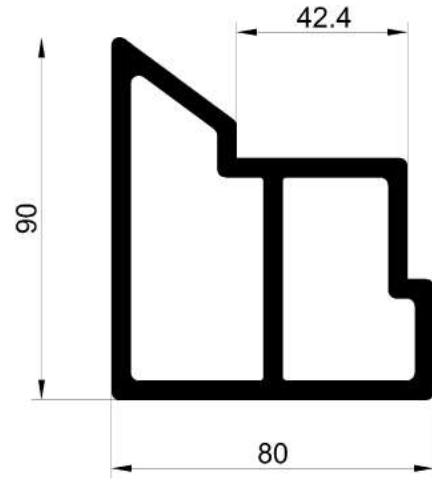

**20378**  
Est Weight: 4.640 kg/m

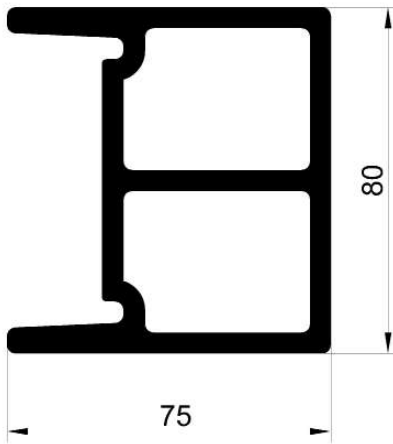

**20379**  
Est Weight: 4.723 kg/m

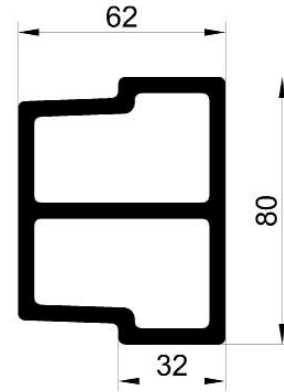

**20380**  
Est Weight: 4.100 kg/m

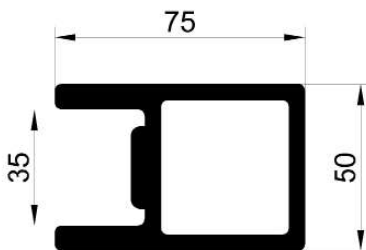

**20382**  
Est Weight: 3.672 kg/m

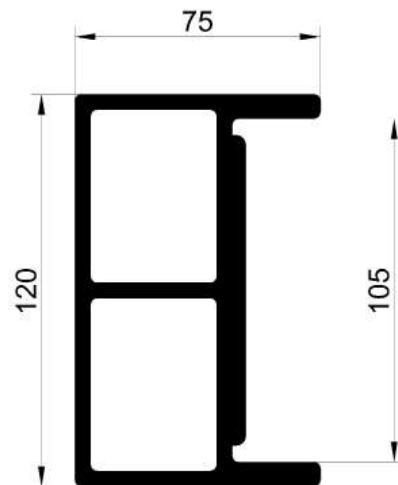

**20383**  
Est Weight: 6.800 kg/m

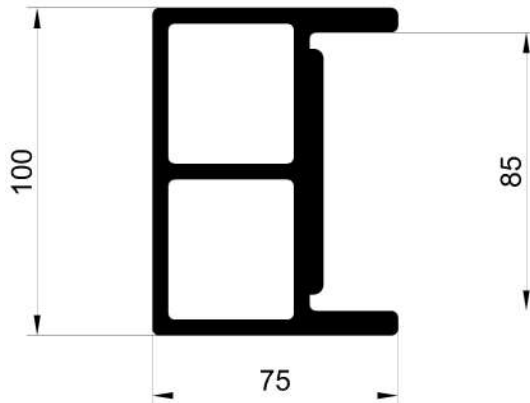

**20386**  
Est Weight: 6.048 kg/m

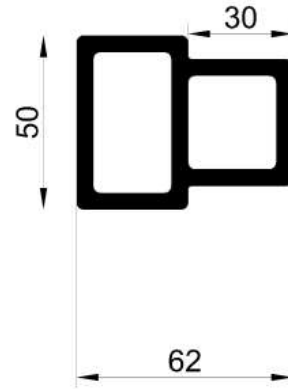

**20385**  
Est Weight: 3.019 kg/m

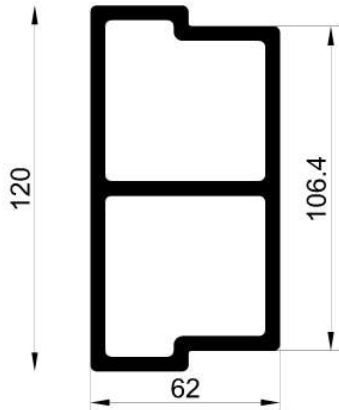

**20388**  
Est Weight: 5.168 kg/m

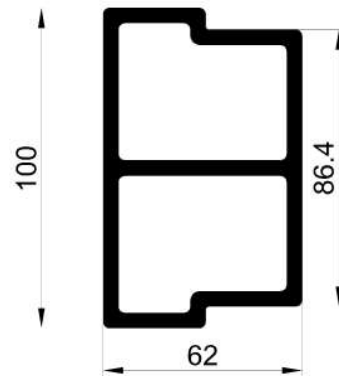

**20387**  
Est Weight: 4.647 kg/m

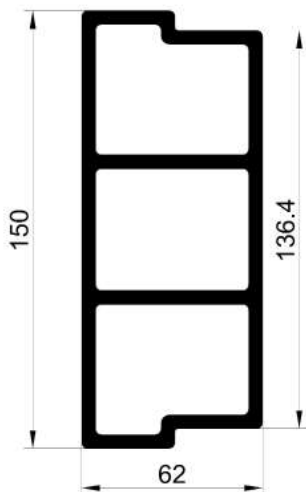

**20390**  
Est Weight: 6.642 kg/m

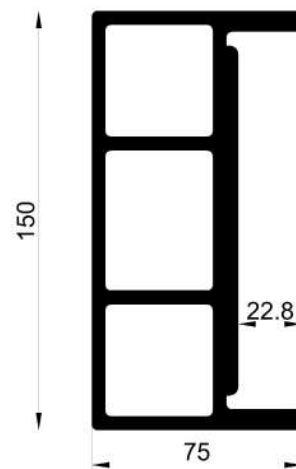

**20389**  
Est Weight: 8.514 kg/m

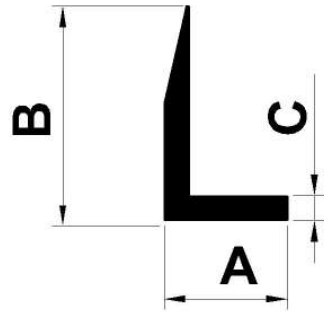

NO	Die No	A (mm)	B (mm)	C (mm)	Kg/m
1	10182	21.2	37.5	3	0.572

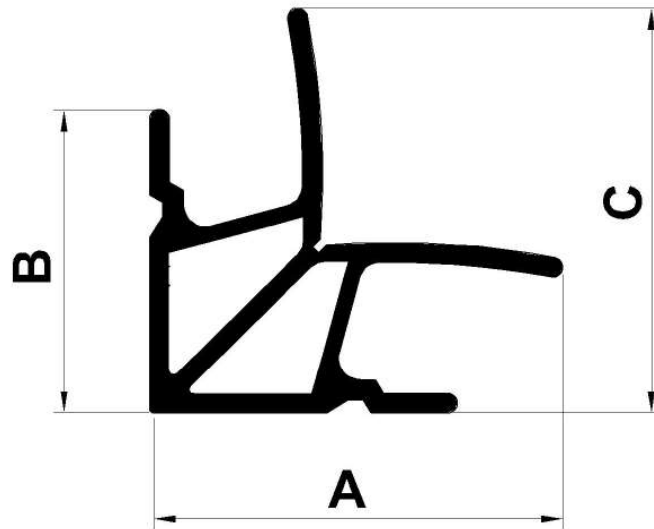

NO	Die No	A (mm)	B (mm)	C (mm)	Kg/m
1	20216	94.1	70.2	94.1	4.290

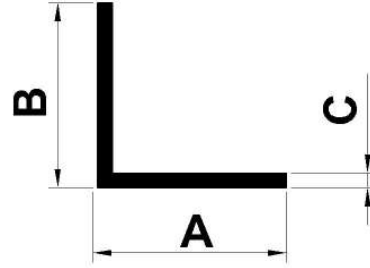

NO	Die No	A (mm)	B (mm)	C (mm)	Kg/m	NO	Die No	A (mm)	B (mm)	C (mm)	Kg/m
1	10177	37	37	3	0.634	8	10017	30	30	3	0.461
2	10178	37	37	2.9	0.596	9	10018	25	25	3	0.378
3	10179	27	27	3.5	0.465	10	10027	30	30	1	0.151
4	10180	27	27	3	0.430	11	10038	20	20	1	0.116
5	10243	36	36	4.4	0.806	12	10358	37	37	2.6	0.485
6	10244	50	50	5	1.287	13	10359	26	26	2.5	0.333
7	10016	36	36	3.6	0.644						

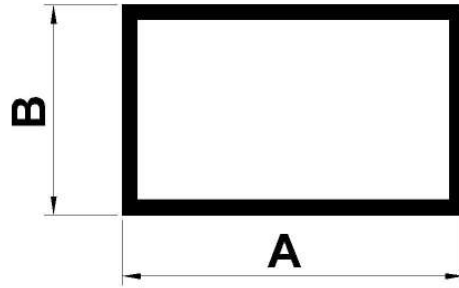

NO	Die No	A (mm)	B (mm)	Kg/m	NO	Die No	A (mm)	B (mm)	Kg/m
1	20036	20	20	0.175	7	20001	40	20	0.317
2	20037	30	30	0.297	8	20002	75	25	0.542
3	20038	100	40	0.890	9	20003	80	40	0.717
4	20188	50	50	0.620	10	20004	40	40	0.400
5	20211	150	50	1.602	11	20094	100	20	0.760
6	20240	100	100	1.497	12	20355	100	30	0.693

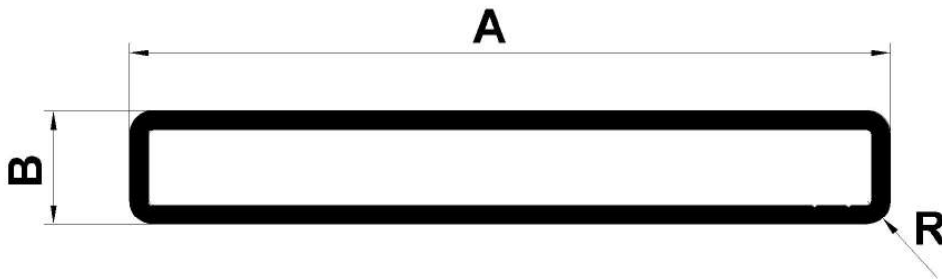

NO	Die No	A (mm)	B (mm)	R (mm)	Kg/m
1	20228	100	15.5	3	1.470

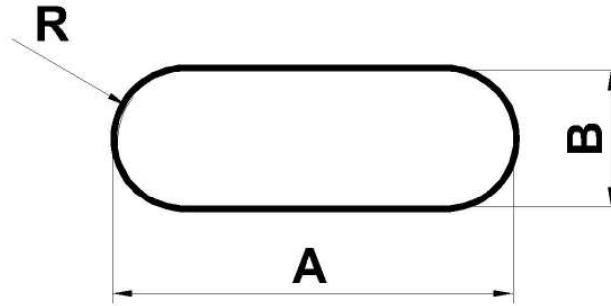

NO	Die No	A (mm)	B (mm)	R (mm)	Kg/m
1	20062	38	10	5	0.224
2	20100	75	27.5	13.8	0.481



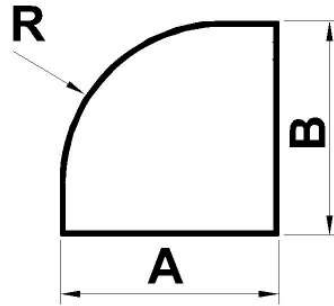

NO	Die No	A (mm)	B (mm)	R (mm)	Kg/m
1	20039	30	30	21	0.306
2	20130	40	40	30	0.329
3	20015	39	39	21	0.383

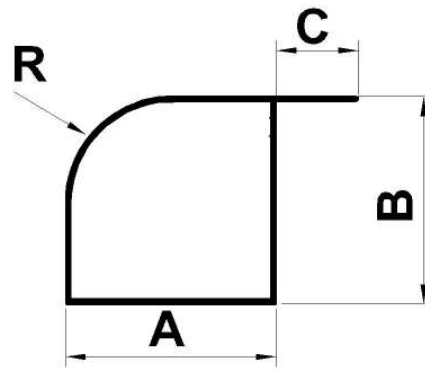

NO	Die No	A (mm)	B (mm)	C (mm)	R (mm)	Kg/m
1	20014	38.5	38.5	15	21	0.421
2	20056	39	39	18	21	0.414
3	20061	30	30	18	20	0.328

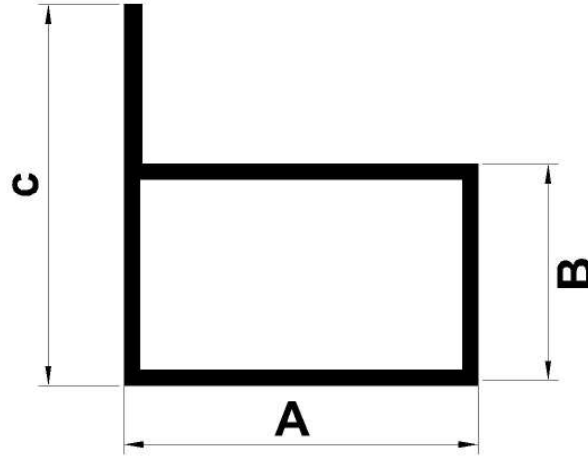

NO	Die No	A (mm)	B (mm)	c (mm)	Kg/m
1	20152	40	20	35	0.396
2	20044	45	20	40	0.402

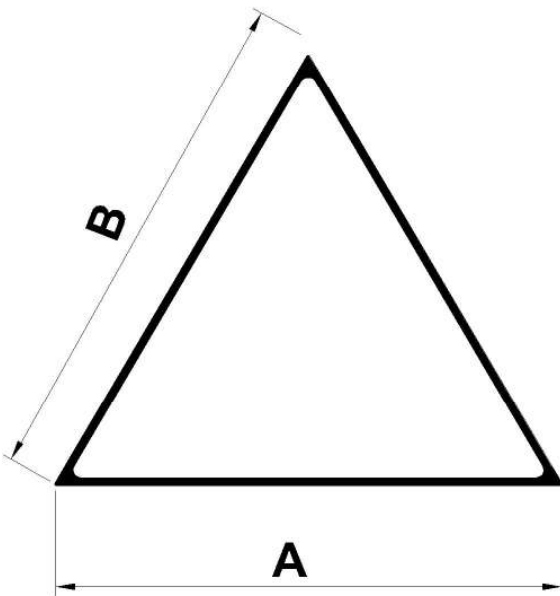

NO	Die No	A (mm)	B (mm)	Kg/m
1	20241	94	94	1.132

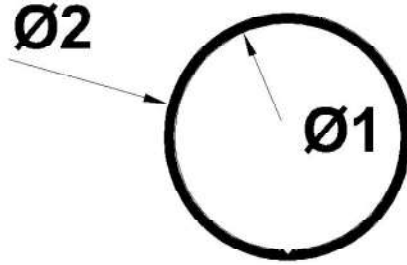

NO	Die No	Ø1 mm	Ø2 mm	Kg/m
1	20288	23.4	25	0.165
2	20184	42	42	0.350
3	20189	69.5	75	1.781
4	20148	8	14	0.280
5	20316	40	45	0.905
6	20366	16.8	19	0.168
7	20368	38	40	0.330
8	20369	30	32	0.265

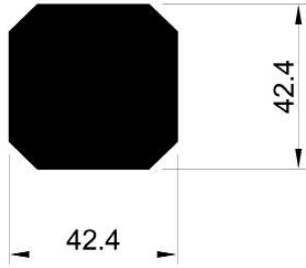

**10000-4A**  
Est Weight: 4.607 kg/m

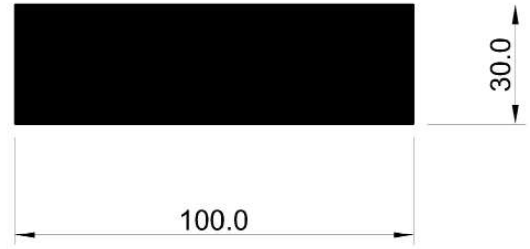

**10000-3A**  
Est Weight: 8.130 kg/m



**10020**  
Est Weight: 2.416 kg/m

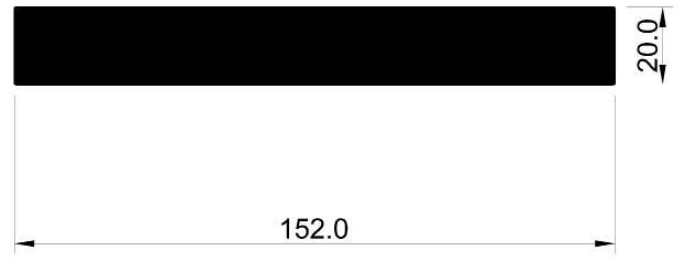

**10022**  
Est Weight: 8.200 kg/m

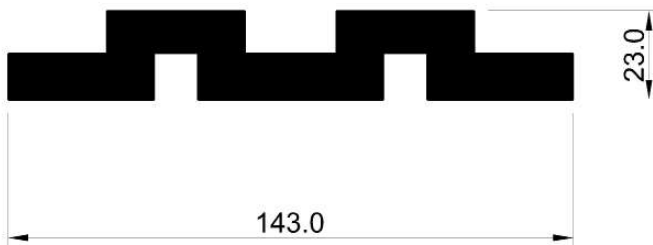

**10000-2A**  
Est Weight: 6.000 kg/m

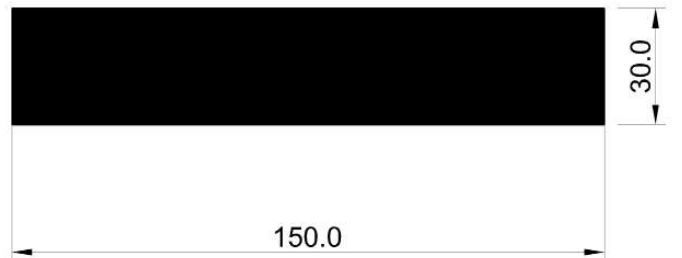

**10000-1A**  
Est Weight: 12.20 kg/m

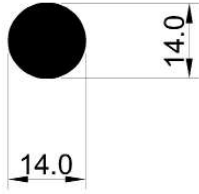

**10145**

**Est Weight: 0.416 kg/m**

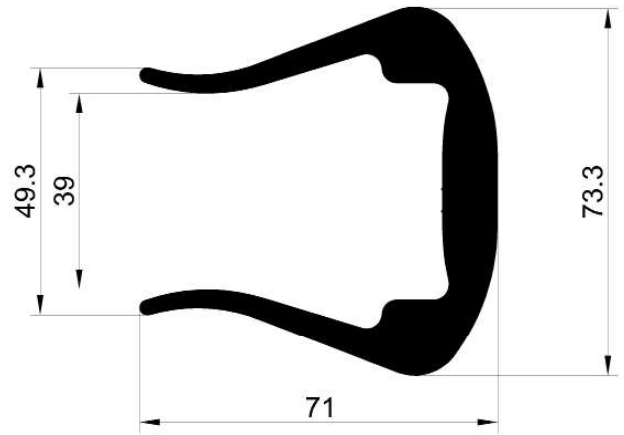

**10105**

**Est Weight: 3.701 kg/m**

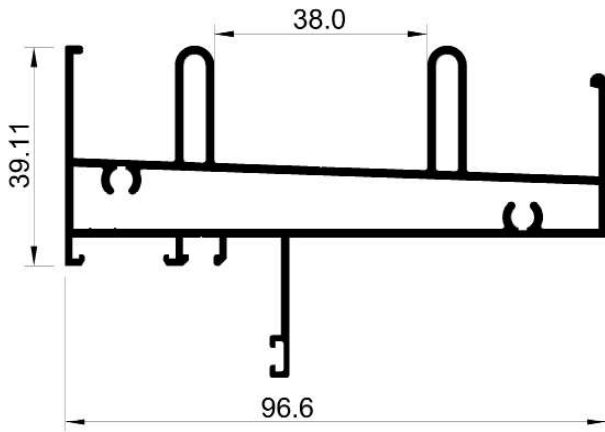

**20289**

**Est Weight: 1.685 kg/m**

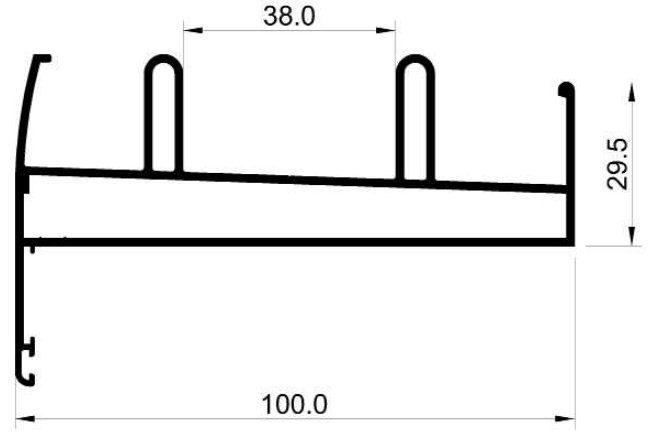

**20290**

**Est Weight: 1.542 kg/m**

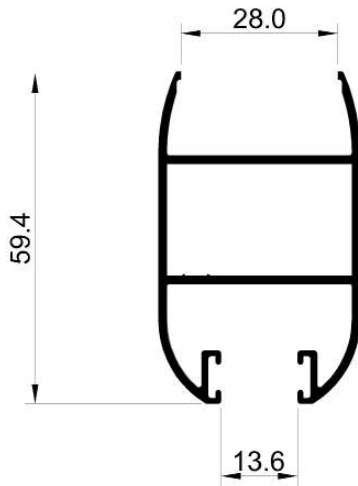

**20291**

**Est Weight: 0.856 kg/m**

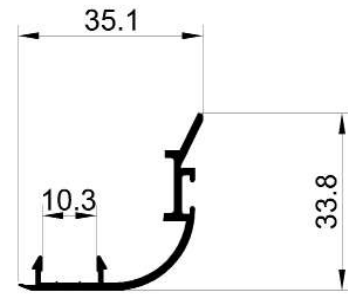

**10300**

**Est Weight: 0.311 kg/m**

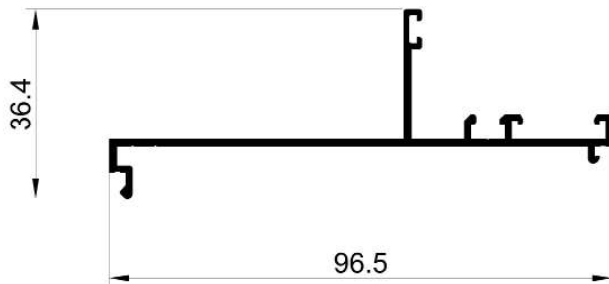

**10301**

**Est Weight: 0.644 kg/m**

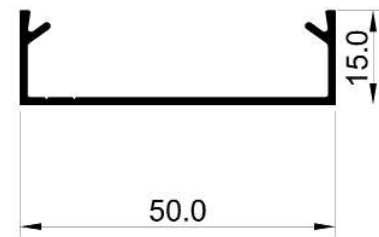

**10302**

**Est Weight: 0.285 kg/m**

سالكو



**10303**

Est Weight: 4.555 kg/m

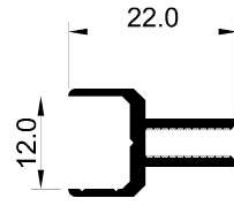

**10304**

Est Weight: 0.199 kg/m

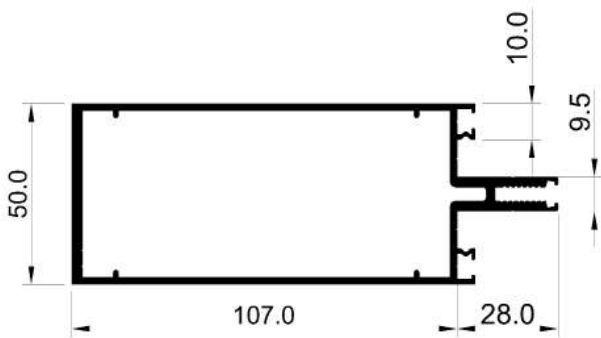

**20295**

Est Weight: 2.313 kg/m

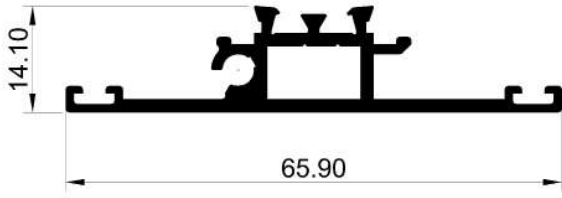

**20292**

**Est Weight: 0.596 kg/m**

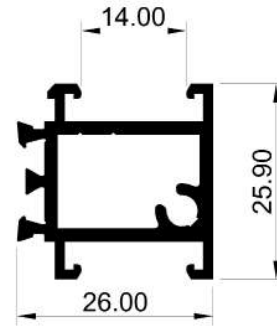

**20293**

**Est Weight: 0.530 kg/m**

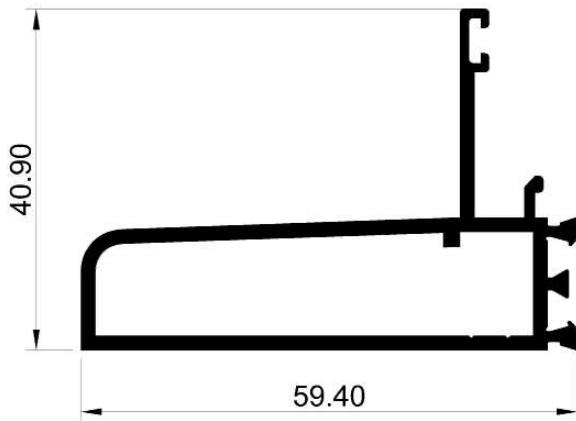

**20294**

**Est Weight: 0.843 kg/m**

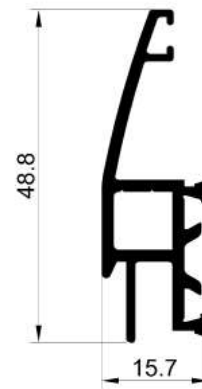

**20301**

**Est Weight: 0.507 kg/m**

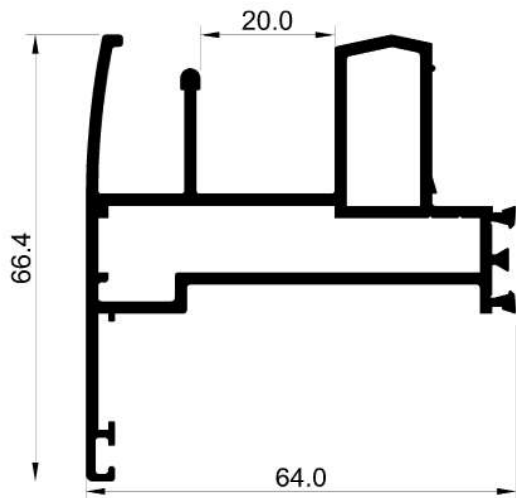

**20302**

**Est Weight: 1.471 kg/m**

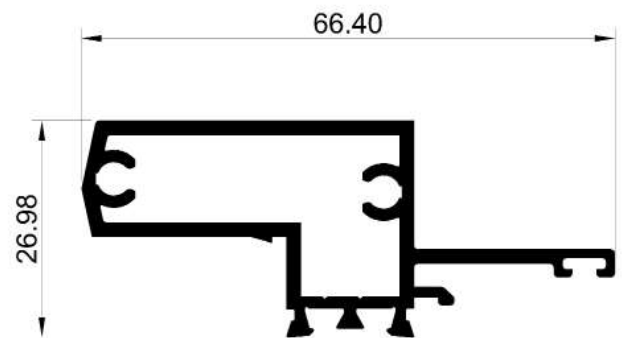

**20303**

**Est Weight: 0.859 kg/m**



سالكو

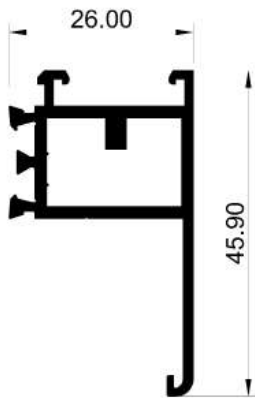

**20297**

Est Weight: 0.590 kg/m

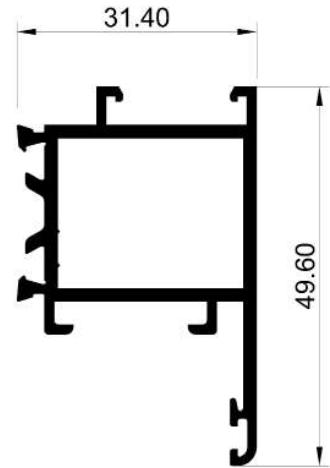

**20298**

Est Weight: 0.728 kg/m

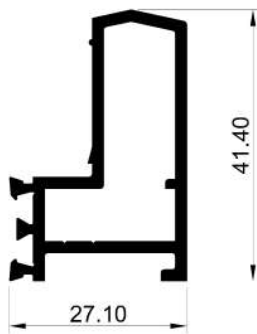

**20299**

Est Weight: 0.661 kg/m

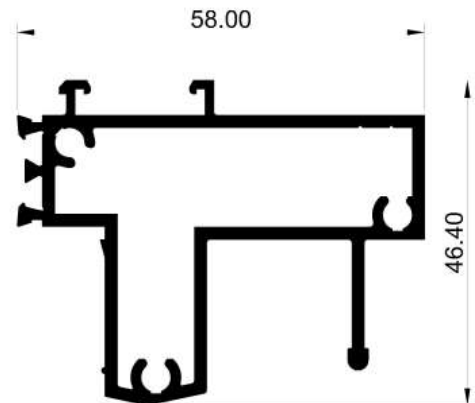

**20300**

Est Weight: 1.186 kg/m

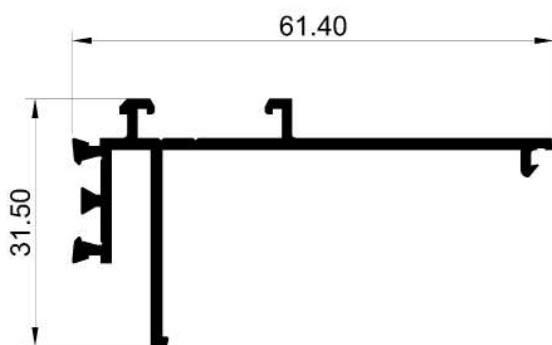

**10307**

Est Weight: 0.518 kg/m

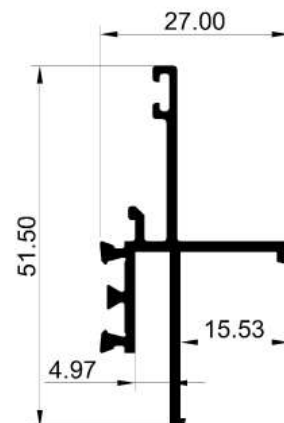

**10308**

Est Weight: 0.455 kg/m



**20304**  
Est Weight: 0.693 kg/m

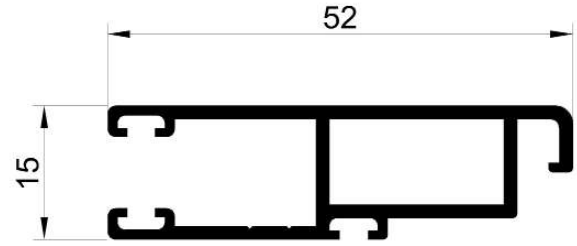

**20296**  
Est Weight: 0.547 kg/m

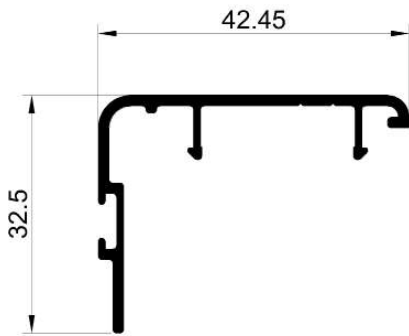

**10305**  
Est Weight: 0.370 kg/m

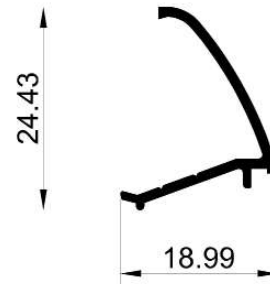

**10306**  
Est Weight: 0.149 kg/m

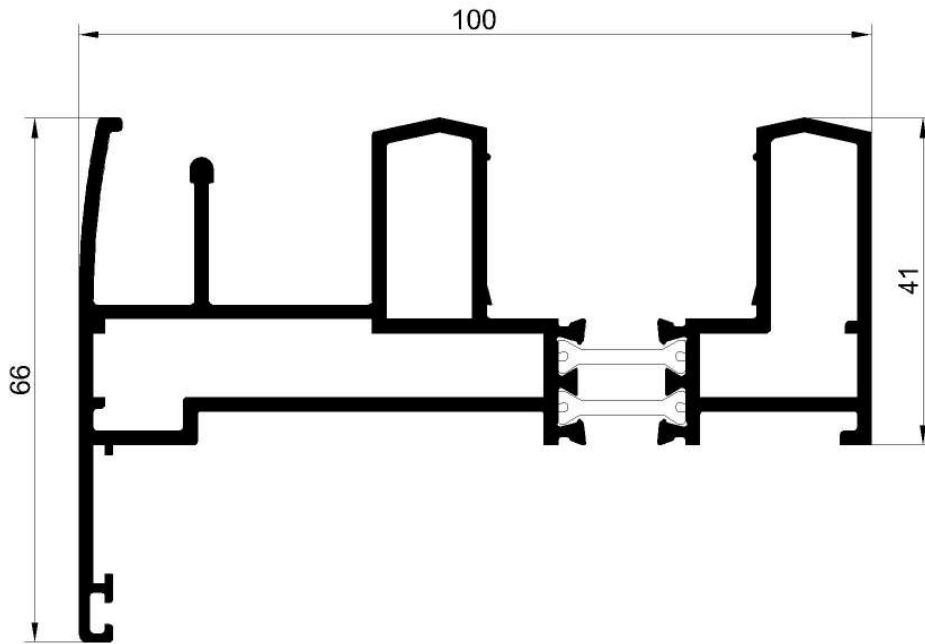

**20302/20299**

**Est Weight: 2.122 kg/m**

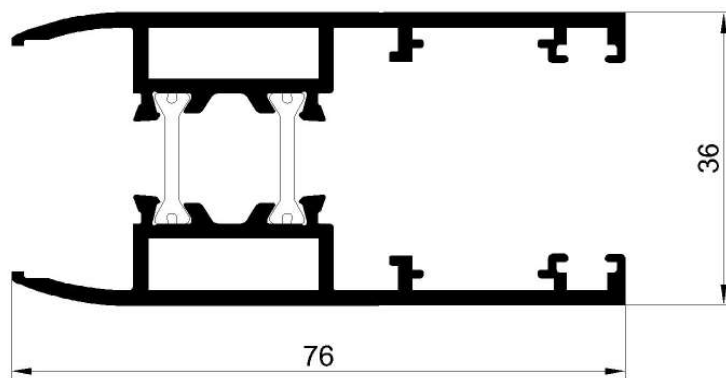

**20304**

**Est Weight: 1.377 kg/m**

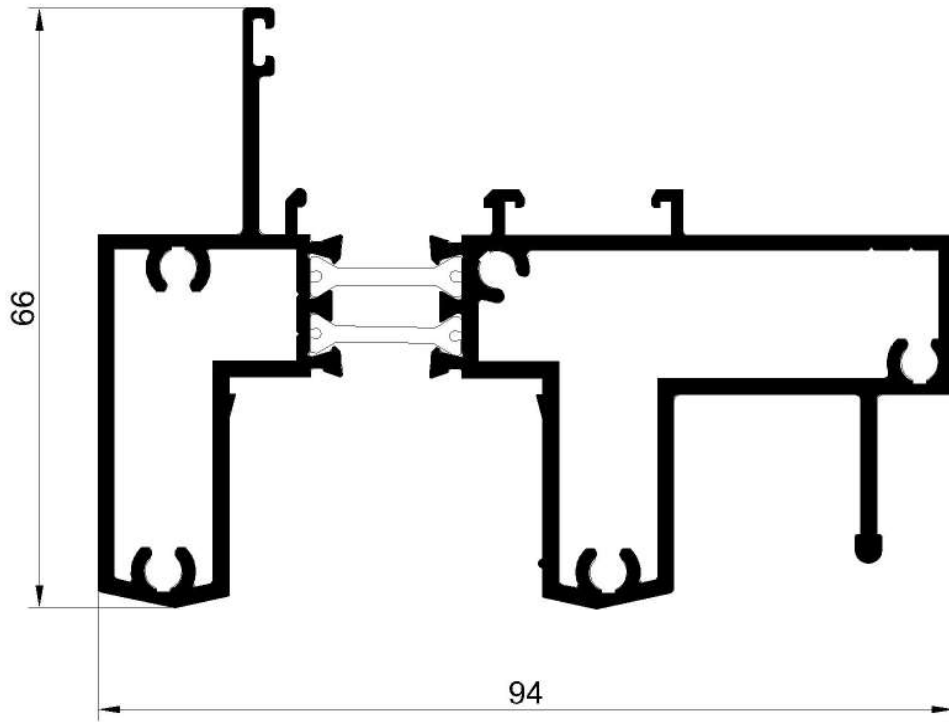

**20303/20300**  
Est Weight: 2.051 kg/m

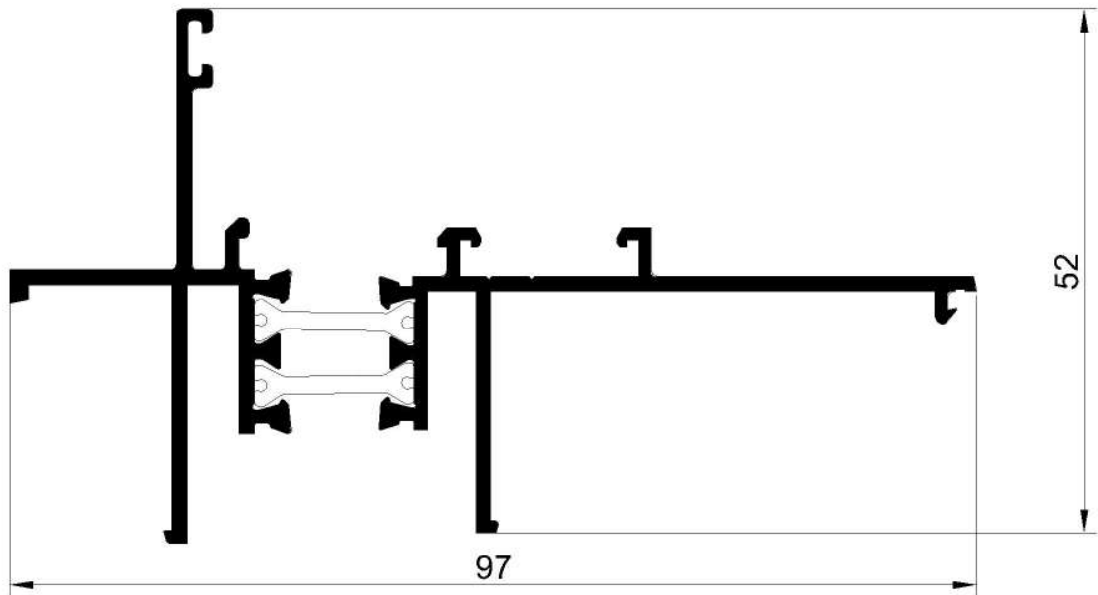

**10307/10308**  
Est Weight: 1.224 kg/m

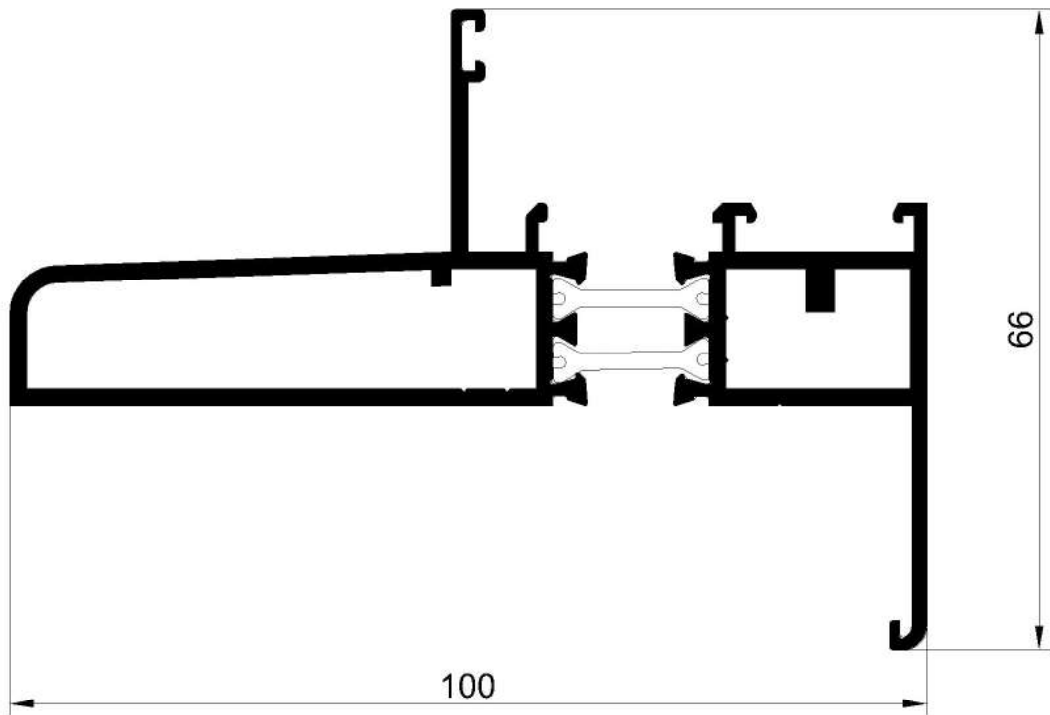

**20294/20297**  
Est Weight: 1.500 kg/m

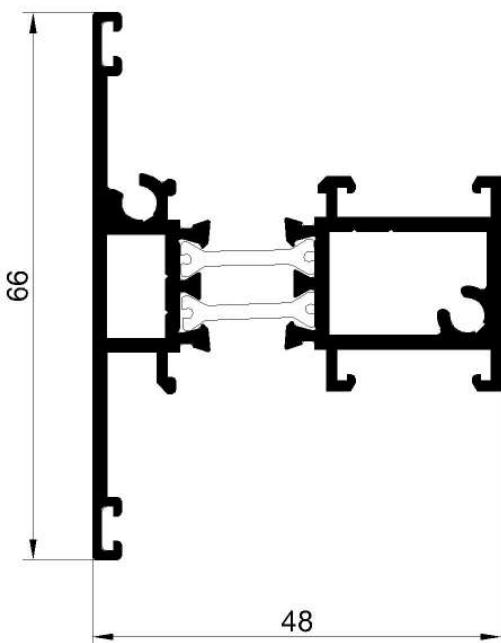

**20292 / 20293**  
Est Weight: 1.300 kg/m

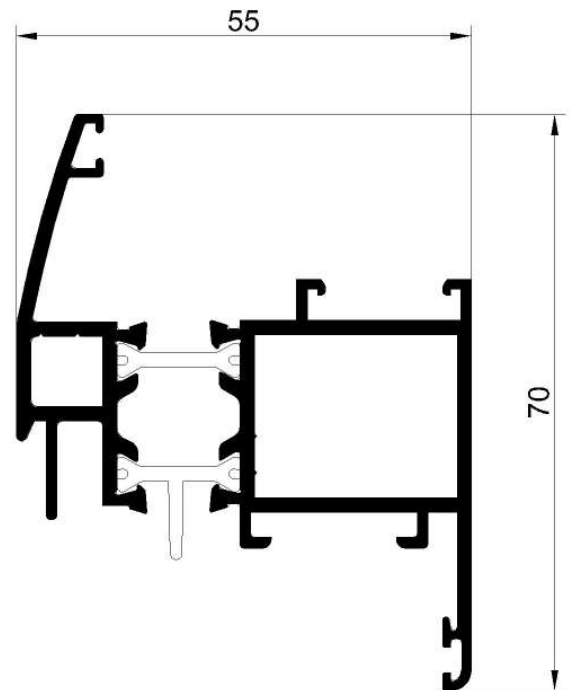

**20298 / 20301**  
Est Weight: 1.300 kg/m

## 1 - الإطار العام

مهمة هذا الجزء تحديد التفاوت المسموح به للأبعاد وشكل ودقة البثق المشكلة من الخلائط المعدنية والمعمول بها في شركتنا EN AW-6063 و EN AW-6063 بوجود أو دون وجود فاصل حراري (راجع الشكلين 1 و 2) كما ذكر سابقا فهي تتوافق مع المعايير الأوروبية وينطبق هذا الأمر على المنتجات المشكلة دون معالجة سطح لاحقة. تمتاز البروفيلات التي تخضع لهذا المعيار بالخصائص التالية:

- إنها في معظمها معدة لتطبيقات معمارية.
- تتلائم مع المتطلبات الأكثر صرامة بالنسبة لحالة السطح للسطوح الظاهرة.
- القطر الأعظمي للدائرة المحيطية هو 350 مم.
- إنها مصنعة ضمن مجالات تسامح متقاربة من حيث الأبعاد والشكل.

في حال البروفيلات والتي بسبب تصميمها المعقد تكون صعبة التصنيع والتشكيل، يجب عندها عقد اتفاق خاص لتحقيق الغاية المرجوة.

### المفتاح

1 - الدائرة المحيطية العظمى 350 مم

### المفتاح

1 - الدائرة المحيطية العظمى 350 مم

2 - حواجز حرارية

الشكل 2 - بروفيل دون حاجز حراري

الشكل 1 - بروفيل يحوي حاجزا حراريا

### 2 - تسامحات الأبعاد

#### 1.2 - فكرة عامة

في حال ولأسباب اضطرارية، كان التسامح المطلوب أدنى مما هو محدد في الشكلين في 1.2.2 و 2.2.2، فإن هذه التسامحات للأبعاد ذات المهام الحرجة تخضع لاتفاق مسبق مع العميل. التخفيض يجب ان لا يتجاوز ثلثي القيمة المحددة في هذا النموذج، كما يجب ان يخضع للحد الأدنى من حزمة التسامحات 0.3 مم.

#### 2,2 - أبعاد المقاطع العرضية:

##### 1.2.2 فكرة عامة:

تسامحات الابعاد التالية (انظر الشكل رقم 3) محددة في الجداول 1 و 2.

A: سماكة الجدران باستثناء تلك السماكات المحيطة بالأماكن المجوفة في المقاطع المجوفة.

B: سماكة الجدران المحيطة بالأماكن المجوفة في المقاطع المجوفة باستثناء تلك التي بين مساحتين فارغتين.

C: سماكة الجدران بين المساحتين الفارغتين في المقاطع المجوفة.

E: طول الساق الأقصر للمقاطع مع النهايات المفتوحة.

H: جميع الابعاد باستثناء (سماكة الجدران) بين نقاط المقطع العرضي او مراكز البراغي بما فيها النهايات المفتوحة.

الشكل 3 - تعريف الأبعاد: A, B, C, E, H

## 2.2.2 تسامحات الأبعاد بدون سماكة الجدران:

كما هي في الجدول 1H التسامحات للأبعاد:

### جدول 1 - تسامحات ابعاد المقاطع العرضية:

وردت الأبعاد بالمليمترات:

التسامح في H (نهايات مفتوحة)		التسامح في H (عدا النهايات المفتوحة)	البعد H	
E ≤ 120 <sup>a</sup> > 60	= E < 60		لغاية وبما فيها	أكثر من
b	0,15 ±	± 0,15	10	-
b	0,20 ±	± 0,20	15	10
b	0,25 ±	± 0,25	30	15
0,45 ±	0,30 ±	± 0,30	45	30
0,55 ±	0,40 ±	± 0,40	60	45
0,65 ±	0,45 ±	± 0,45	90	60
0,80 ±	0,60 ±	± 0,60	120	90
1,0 ±	0,80 ±	± 0,80	150	120
1,3 ±	1,0 ±	± 1,0	180	150
1,5 ±	1,2 ±	± 1,2	240	180
1,8 ±	1,5 ±	± 1,5	300	240
2,1 ±	1,8 ±	± 1,8	350	300

ملاحظة: التسامحات المعطاة في الجدول 1 لا تغطي الأبعاد بين نقطتين داخل وخارج التجويف

a - تخضع حالات التسامح للبعد E أكثر من 120 مم لاتفاق مسبق مع العميل.

b - تخضع لاتفاق مسبق مع العميل.



### 3.2.2 تسامحات سماكة البروفيلات المفتوحة والمجوفة

تسامحات السماكة للبروفيلات المفتوحة والمجوفة في الجدول 2 راجع الشكل 3.

#### جدول 2 - حالات التسامح بالنسبة لسماكة الجدار للبروفيلات المفتوحة والمجوفة:

وردت الأبعاد بالملليمترات:

التسامح بالنسبة ل:				سماكة الجدار الإسمية A - B - C	
سماكة الجدار في B و C		سماكة الجدار A		لغاية وبما فيها	أكثر من
الدائرة > 100 المحيطة = > 350	الدائرة المحيطة 100 = >	الدائرة > 100 المحيطة = > 350	الدائرة المحيطة اقل من 100		
0,30 ±	0,20 ±	0,20 ±	0,15 ±	2	-
0,40 ±	0,25 ±	0,25 ±	0,15 ±	3	2
0,60 ±	0,40 ±	0,30 ±	0,20 ±	6	3
0,80 ±	0,60 ±	0,35 ±	0,25 ±	10	6
0,1 ±	0,80 ±	0,40 ±	0,30 ±	15	10
1,5 ±	1,2 ±	0,45 ±	0,35 ±	20	15
a	a	0,50 ±	0,40 ±	30	20
a	a	0,60 ±	0,45 ±	40	30

a - تخضع لاتفاق مسبق مع العميل.

عندما ولأسباب وظيفية، تكون التسامحات للأبعاد الداخلية والخارجية محددة للبروفيلات المجوفة، بالتالي فإن الانحرافات المعطاة في الجدول 2 لن تطبق كما هي الحال في تسامح سماكة الجدار بل وفقاً للتسامح بالنسبة للفرق في سماكة الجدار. هذا الفرق يجب ان يحسب بقياس سماكة البروفيل العظمى والصغيرة لنفس السطح.

### 3.2 الطول:

في حال تم إعطاء الأطوال الثابتة فلا بد من ذكر هذا الأمر في طلب الشراء. تكون حالات تسامح الطول الثابت كما هي واردة في الجدول 3.

#### جدول 3 - تسامحات الاطوال الثابتة

وردت الأبعاد بالمليمترات:

تسامح الطول الثابت L				الدائرة المحيطية	
L > 10000	L <= 10000 < 5000	L <= 5000 < 2000	L <= 2000	لغاية وبما فيها	أكثر من
تخضع لاتفاق مسبق مع العميل	10 +	7 +	5 +	100	-
	0	0	0		
	12 +	9 +	7 +	200	100
	0	0	0		
	14 +	11 +	8 +	350	200
0	0	0			

في حال لا يتضمن طلب الشراء أي أطوال ثابتة يمكن أن يتم توريد البروفيلات بأطوال عشوائية. يجب أن يخضع مدى الطول وحالات التسامح بالنسبة للأطوال العشوائية لاتفاق مسبق مع العميل.

#### 4,2 ميلان النهايات المقصوفة:

يجب أن يكون تسامح ميول النهايات المقصوفة ضمن نصف مدى التسامح الطولي الوارد في الجدول 3 لكلا الطولين الثابت والعشوائي أي بالنسبة لتسامح الطول الثابت + 10 / صفر يجب أن يكون الانحراف عن تعامد النهايات المقصوفة ضمن 5 مم مقاسة وفق كافة مقاطع البروفيل ذي المقطع العرضي الكامل.

#### 5,2 معادلة طول البروفيل ذو حاجز حراري:

يجب أن تكون معادلة الطول K (راجع الشكل 4) للبروفيلات ذات الحاجز الحراري ضمن مدى التسامح بالنسبة للطول الثابت الوارد في الجدول 3، أي بالنسبة لتسامح طول ثابت + 10 / صفر يجب أن تكون معادلة الطول ضمن 10 مم.

### المفتاح

- 1 - طول البروفيل
- 2 - بروفييل 1
- 3 - حاجز حراري
- 4 - بروفييل 2

### شكل 4 - معادلة الطول K

### 3 تسامحات الشكل:

#### 1.3 تسامحات توازي السطوح:

يجب ان تخضع تسامحات توازي السطوح الخارجية المتقابلة لاتفاق مسبق مع العميل ويذكر ذلك على الرسم. يجب أن يتم تدوين توازي السطوح على الرسم وفقا لما ورد في الشكل 5 باستخدام الرمز // . يجب ألا يزيد التسامح في توازي السطوح عن تسامح الأبعاد أي يجب أن يمتد دوما ضمن التسامح البعدي أو مدى التسامح.

في حال كانت سطوح خارجية بأطوال غير متساوية يكون الأطول هو مرجع تماس.

يجب تعيين نقطتين مرجعيتين واضحة التحديد من أجل قياس عرض توازي السطوح.

يجب تطابق توازي السطوح مع مدى التسامح الوارد في الجدول 1 بالنسبة للأبعاد H (بما فيها تلك العائدة للنهايات المفتوحة) وتطبق فقط على قياسات المقاطع العرضية في سطح واحد .

ليست المتطلبات في الشكل (// 0,4) إلا مثلا . اما التسامحات فوفقا « للجدول 1 :

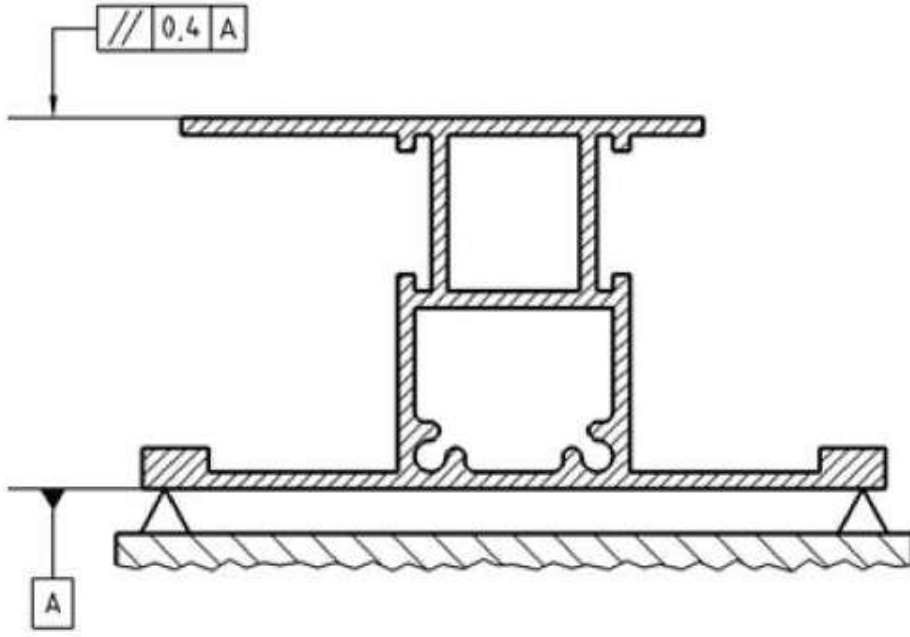

الشكل 5 - تعليم توازي السطوح بالنسبة لسطوح مقعرة ومحدبة

### 2,3 الاستقامة:

يجب أن يتم قياس الانحرافات عن الاستقامة،  $h_t$  و  $h_s$  كما هو مبين في الشكل 6 حين يكون البروفيل موضوعا على قاعدة مسطحة أفقية بحيث تخفف كتلته من الانحراف.  
يجب أن يكون تسامح الاستقامة وفقا لما ورد في الجدول 4.  
يجب ألا يتجاوز الانحراف المحلي  $h_s$  0.3 مم لكل 300 مم طول.

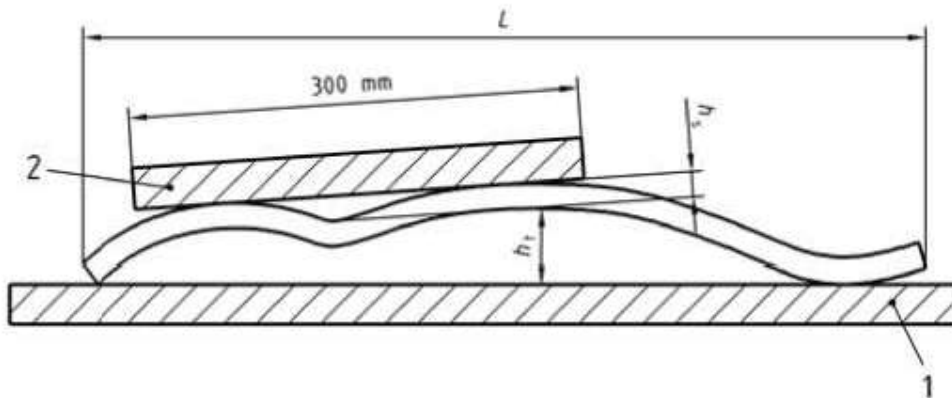

### المفتاح

1- قاعدة مسطحة

2- حافة مستقيمة

الشكل 6 - قياس الانحراف عن الاستقامة

### جدول 4 تسامحات الاستقامة

وردت الأبعاد بالمليمترات:

تسامح الاستقامة ht لطول محدد L						
L > 6000	L ≤ 6000 > 5000	L ≤ 5000 > 4000	L ≤ 4000 > 3000	L ≤ 3000 > 2000	L ≤ 2000 > 1000	L ≤ 1000
3,5	3,0	2,6	2,2	1,8	1,3	0,7

### 3,3 التحذب - التقعر:

يجب أن يتم قياس التحذب - التقعر f وفقا لما هو مبين في الشكلين 7 و 8 والتسامح وفقا لما هو محدد في الجدول رقم 5.

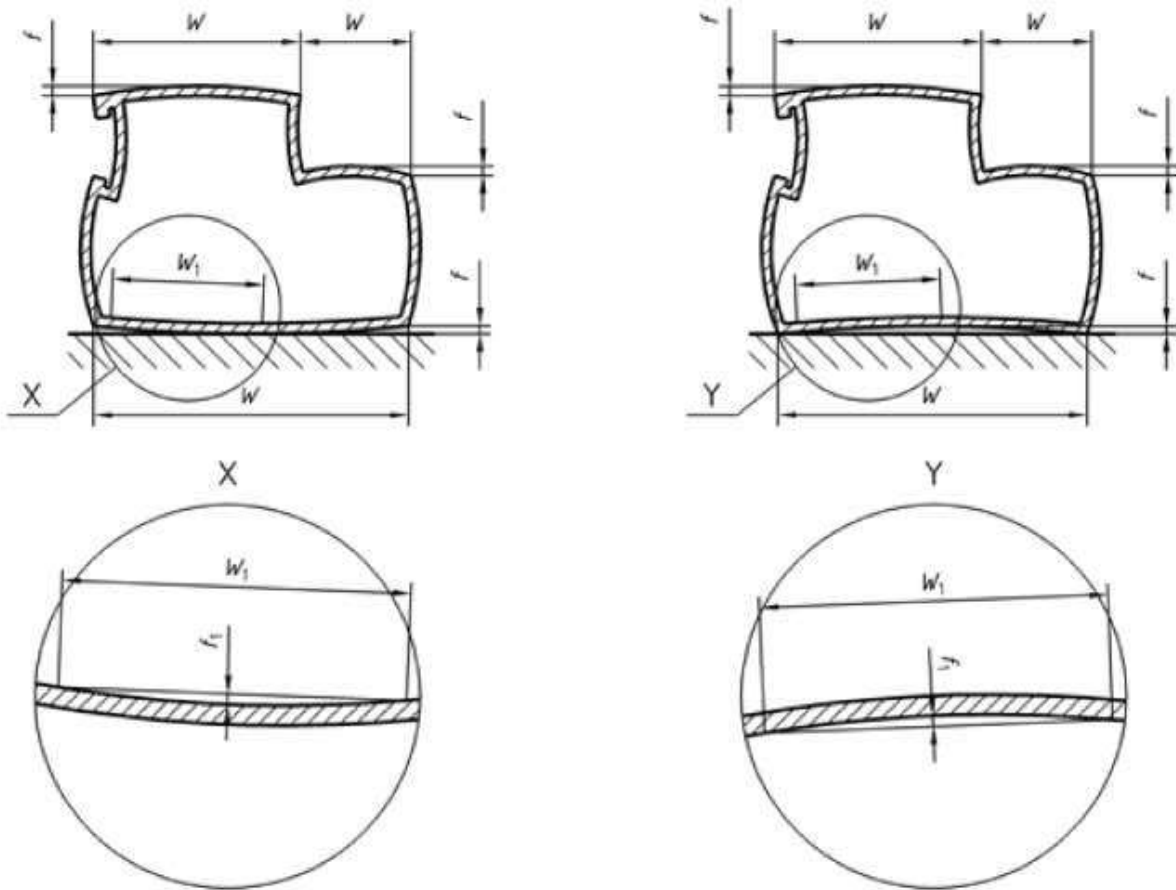

المفتاح:

$f_1 =$  انحراف موضعي لكل 100 مم

$W_1 = 100$  مم

$f =$  الانحراف

$W =$  العرض

الشكل 7 - قياس التحذب - التقعر للمقاطع المجوفة

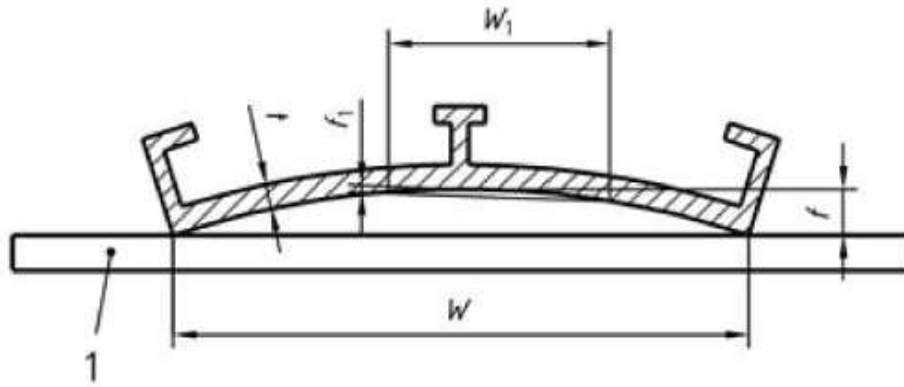

المفتاح:

1 = قاعدة مسطحة = W العرض = f الانحراف = W1 = 100 مم = f1 انحراف موضعي لكل 100 مم

الشكل 8 - قياس التحدب - التقعر للمقطع المفتوح

جدول 5 - حالات تسامح التحدب - التقعر

وردت الأبعاد بالمليمترات:

الانحراف الأعظمي المسموح به f	العرض W	
	لغاية وبما فيها	أكثر من
0,20	30	-
0,30	60	30
0,40	100	60
0,50	150	100
0,70	200	150
0,85	250	200
1,0	300	250
1,2	350	300

في حال البروفيلات حيث العرض يتجاوز 150 مم، يجب ألا يتجاوز الانحراف الموضعي f1 0,50 لكل عرض W1 قياس 100 مم.

### 4,3 المحيط:

بالنسبة للبروفيلات ذات المقاطع العرضية المنحنية، الانحراف من أي نقطة من المنحني من الخط النظري كما هو وارد في الرسم، يجب ان لا يكون اكبر من التسامح المحدد C الوارد في الجدول 6. اعتبارا لكافة النقاط على المنحني، يجب أن تحدد منطقة التسامح. كالمنطقة ما بين مغلفين يجريان بظل الزاوية لكافة الدوائر بقطر C الذي يمكن رسمه مع مراكزها الممتدة على طول الخط الحقيقي نظريا وهذا ما يبينه الشكل 9.

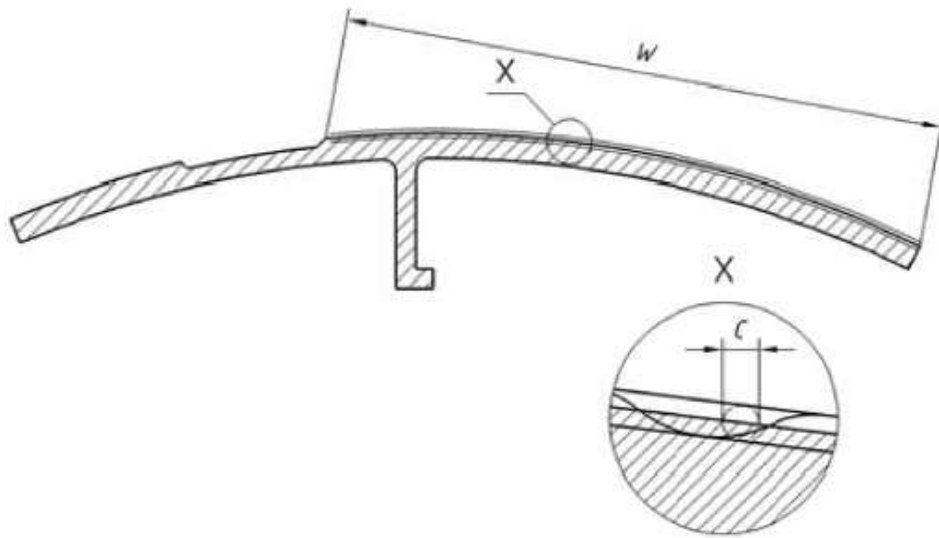

الشكل 9 - تحديد حالات تسامح المحيط

### جدول 6 حالات تسامح المحيط

وردت الأبعاد بالمليمترات:

تسامح المحيط = القطر C لدائرة التسامح	عرض المحيط W	
	لغاية وبما فيها	أكثر من
0,30	30	-
0,50	60	30
0,70	90	60
1,00	120	90
1,20	150	120
1,50	200	150
2,00	250	200
2,50	300	250
3,00	350	300

ملاحظة: يمكن تدقيق حالات تسامح المحيط بوضع مقطع البروفيل على إسقاط سلمي للرسم مع تسامح المحيط المشار إليه في الرسم. هناك طريقة أخرى موصى بها وهي استخدام معيار مناسب (أدنى/ أعظمي).

### 5.3 الفتلان (الالتواء)

يجب أن يتم قياس الفتلان T وفقا لما هو مبين في الشكل 10 بوضع البروفيل على قاعدة مسطحة مع ترك البروفيل يرتاح تحت قوة ثقله وقياس المسافة العظمى في أي نقطة على مدى الطول ما بين طرف البروفيل ووسط القاعدة المسطحة.

يجب أن يتم توصيف حالات التسامح في الجدول 7 بالنسبة للمتغيرين عرض البروفيل W وطوله L.

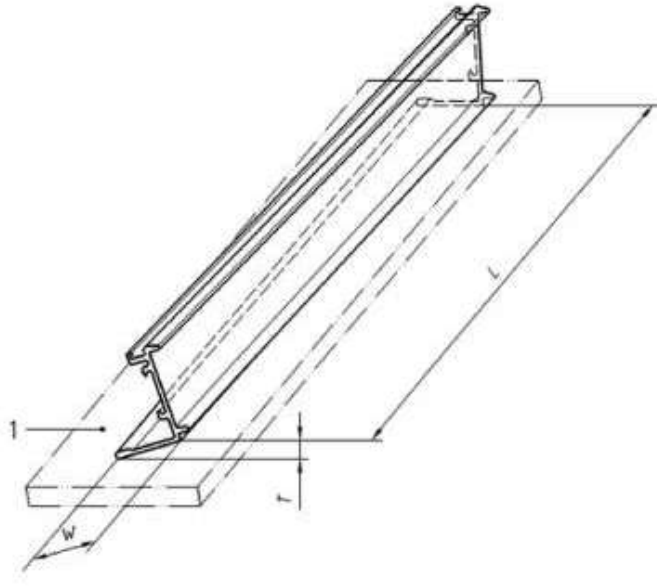

المفتاح:

1 قاعدة مسطحة

الشكل 10 - الالتواء (الفتلان)

جدول 7 تسامحات الالتواء

وردت الأبعاد بالمليمترات:

تسامح الالتواء T بالنسبة للطول L					عرض البروفيل W			
L > 6000	L ≤ 6000 > 5000	L ≤ 5000 > 4000	L ≤ 4000 > 3000	L ≤ 3000 > 2000	L ≤ 2000 > 1000	L ≤ 1000	لغاية وبما فيها	اكثر من
تخضع لاتفاق مسيق مع العميل	2,0	2,0	1,8	1,5	1,2	1,0	75	-
	2,5	2,2	2,0	1,5	1,2	1,0	100	75
	3,0	2,5	2,2	1,8	1,5	1,0	125	100
	3,0	2,5	2,2	1,8	1,5	1,2	150	125
	3,5	3,0	2,6	2,2	1,8	1,5	200	150
	4,5	4,0	3,5	3,0	2,5	1,8	350	200



### 6.3 تسامحات التعامد

يجب أن يتم قياس تسامحات الزوايا كما هو مبين في الشكلين 11 و 12.

قياس تسامحات التعامد للزوايا القائمة كما هو مبين في الجدول 8 بالنسبة لعرض البروفيل  $W$ . التسامح الأعظمي المسموح به  $\alpha$  للزوايا الأخرى عدا الزاوية القائمة  $\pm 1^\circ$  ( راجع الشكل 12).  
في حال عدم تساوي الأطوال الجانبية يتم تطبيق تسامح بالنسبة للزوايا على الجانب الأقصر للزاوية ويبدأ بالقياس من الجهة الأطول.

### جدول 8 - تسامحات الزوايا القائمة

وردت الأبعاد بالمليمترات:

الانحراف المسموح به الأعظمي من زاوية قائمة Z	عرض W	
	لغاية وبما فيها	أكثر من
0,30	30	-
0,40	50	30
0,50	80	50
0,60	100	80
0,70	120	100
0,80	140	120
0,90	160	140
1,0	180	160
1,2	200	180
1,5	250	200

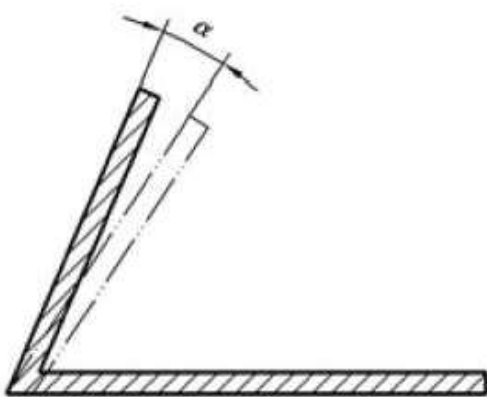

شكل 12 - قياس تسامح الزوايا عدا القائمة

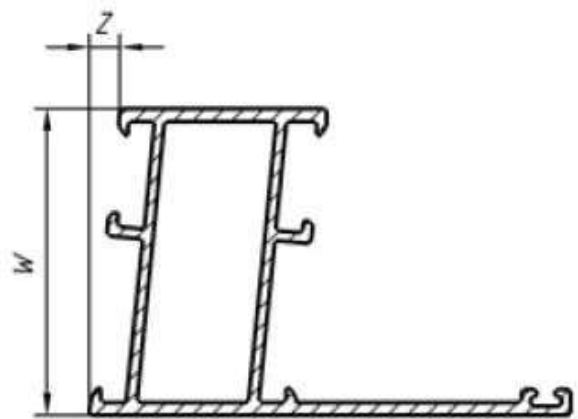

شكل 11- قياس تعامد الزاوية القائمة

## 7.3 حواف وأطراف البروفيلات:

تكون حواف وزوايا البروفيل مدورة قليلا إلا إذا ذكر في الرسم خلاف ذلك. يجب أن يكون نصف قطر القوس لأطراف البروفيل المسموح به وفقا للجدول 9. عند تحديد نصف قطر الأقواس للحواف تسامح هذه الاقواس والحواف الأعظمي يكون وفق الجدول 10.

### جدول 9 – الأقواس والحواف المسموح بها:

نصف قطر القوس الأعظمي	سماكة الجدار A <sup>a</sup> ، B <sup>a</sup> ، C <sup>a</sup>	
	لغاية وبما فيها	أكثر من
0,5	3	-
0,6	6	3
0,8	10	6
1,0	20	10
1,5	40	20

a حين تكون سماكة الجدار المتغيرة متشابهة، يكون نصف قطر القوس المسموح به في منطقة الانتقال تابعا لأكبر سماكة جدار.

### جدول 10 – تسامحات الاقواس الأعظمية والحواف لأطراف البروفيل:

نصف قطر القوس للحواف مم حتى أكثر من وبما فيها	انحرافات عظمى مسموح بها بالنسبة لنصف قطر قوس الحافة
0,30 ± ملم	أقل من 1,0
0,50 ± ملم	أقل من 0,1 حتى أقل من 5,0
±10 %	أكثر من 0,5



## 1- Scope

This section specifies tolerances on dimensions and form of extruded precision profiles that are followed by our company, in alloys EN AW6060 and EN AW-6063 manufactured with and without a thermal barrier (see Figures 1 and 2), As mentioned earlier, these tolerances conform to European Standards, It applies to extruded products supplied without further surface treatment, Precision profiles covered in this standard are distinguished by the following characteristics:

- They are mainly for architectural applications;
- They meet more stringent requirements regarding the surface condition of visible surfaces;
- The maximum diameter of the circumscribing circle  $CD$  is 350 mm;
- They are made to closer tolerances on dimensions and form,

In the case of profiles which, due to the complexity of their design, are difficult to manufacture and specify, then special agreements may need to be reached,

1 - Circumscribing circle maximum 350 mm

**Figure 1 - Profile without thermal barrier**

1 - Circumscribing circle maximum 350 mm  
2 - Thermal barriers

**Figure 2 - Profile containing thermal barrier**

## 2 - Tolerances on dimensions

### 2,1 - General

If, for compelling reasons, tolerances closer than those specified in 2,2,1 and 2,2,2 are required, these shall only be specified for dimensions that are critical to the function, prior to the placement of the order by the client, Any such reduction shall not exceed two-thirds of the values specified in this standard and is subject to a minimum tolerance band of 0,3 mm,

### 2,2 - Cross-sectional dimensions

#### 2,2,1 - General

The tolerances of the following dimensions (see Figure 3) are specified in Tables 1 and 2,

A: Wall thicknesses except those enclosing the hollow spaces in hollow profiles;

B: Wall thicknesses enclosing the hollow spaces in hollow profiles, except those between two hollow spaces;

C: Wall thicknesses between two hollow spaces in hollow profiles;

E: The length of the shorter leg of profiles with open ends;

H: All dimensions (except wall thickness) between points on the cross section of the profile or the centres of open screw holes, including open ends,

Figure 3 - Definition of dimensions A, B, C, E, H



## 2,2,2 Tolerances on dimensions other than wall thickness

The tolerances for dimension  $H$  shall be as specified in Table 1,

**Table 1 - Tolerances on cross-sectional dimensions**

Dimensions in millimetres

Dimension $H$		Tolerances on $H$ (except open ends)	Tolerances on $H$ (open ends)	
Over	Up to and including		$E \leq 60$	$E \leq 120 > 60$ <sup>a</sup>
-	10	0,15 ±	0,15 ±	b
10	15	0,20 ±	0,20 ±	b
15	30	0,25 ±	0,25 ±	b
30	45	0,30 ±	0,30 ±	0,45 ±
45	60	0,40 ±	0,40 ±	0,55 ±
60	90	0,45 ±	0,45 ±	0,65 ±
90	120	0,60 ±	0,60 ±	0,80 ±
120	150	0,80 ±	0,80 ±	1,0 ±
150	180	1,0 ±	1,0 ±	1,3 ±
180	240	1,2 ±	1,2 ±	1,5 ±
240	300	1,5 ±	1,5 ±	1,8 ±
300	350	1,8 ±	1,8 ±	2,1 ±

**NOTE** Tolerances given in Table 1 do not cover dimensions from a given point inside a closed hollow chamber to any other point outside the chamber,

a, Tolerances for values of dimension  $E$  over 120 mm shall be subject to prior agreement with the client

b, Shall be subject to prior agreement with the client

## 2,2,3 - Tolerances on wall thickness of solid and hollow profiles

The tolerances on wall thickness (see Figure 3) of solid and hollow profiles shall be as specified in Table 2,

**Table 2 - Tolerances on wall thickness of solid and hollow profiles**

Dimensions in millimetres

Nominal wall thickness A, B or C		Tolerances on:			
Over	Up to and including	Wall thickness A		Wall thickness B and C	
		Circumscribing circle CD ≤ 100	Circumscribing circle 100 < CD ≤ 350	Circumscribing circle CD ≤ 100	Circumscribing circle 100 < CD ≤ 350
-	2	± 0,15	± 0,20	± 0,20	± 0,30
2	3	± 0,15	± 0,25	± 0,25	± 0,40
3	6	± 0,20	± 0,30	± 0,40	± 0,60
6	10	± 0,25	± 0,35	± 0,60	± 0,80
10	15	± 0,30	± 0,40	± 0,80	± 1,0
15	20	± 0,35	± 0,45	± 1,2	± 1,5
20	30	± 0,40	± 0,50	a	a
30	40	± 0,45	± 0,60	a	a

a - Shall be subject to prior agreement with the client,

When, for functional reasons, tolerances are specified for both the outside and inside dimensions of hollow sections, then the deviations given in Table 2 shall not apply as a wall thickness tolerance, but as a tolerance on the difference in wall thickness, This difference shall be determined by measuring the maximum and minimum wall thickness in the same plane,



## 2,3 - Length

If fixed lengths are to be supplied, this shall be stated on the order, The fixed length tolerances shall be as specified in Table 3,

**Table 3 - Tolerances on fixed length**

Dimensions in millimetres

Circumscribing circle CD		Tolerances on fixed length L			
Over	Up to and including	$L \leq 2\,000$	$2\,000 < L \leq 5\,000$	$5\,000 < L \leq 10\,000$	$L > 10\,000$
-	100	5 +	7+	10+	Shall be subject to prior agreement with the client
		0	0	0	
100	200	7+	9+	12+	
		0	0	0	
200	350	8+	11+	14+	
		0	0	0	

If no fixed or minimum length is specified in the order, profiles may be delivered in random lengths, The length range and the tolerances on the random lengths shall be subject to prior agreement with the client,

## 2 , 4 Squareness of cut ends

The squareness of cut ends shall be within half of the fixed length tolerance range specified in Table 3 for both fixed and random lengths, e,g, for a fixed length tolerance of 0 / 10 + mm the deviation from squareness of cut ends shall be within 5 mm measured over all the complete cross sectional width of the profile,

## 2 , 5 - Length offset for profiles with a thermal barrier

Length offset K, see Figure 4, for profiles with a thermal barrier shall be within the tolerance range for the fixed length specified in Table 2, e,g, for a fixed length tolerance of 0 / 10 + mm the length offset shall be within 10 mm,

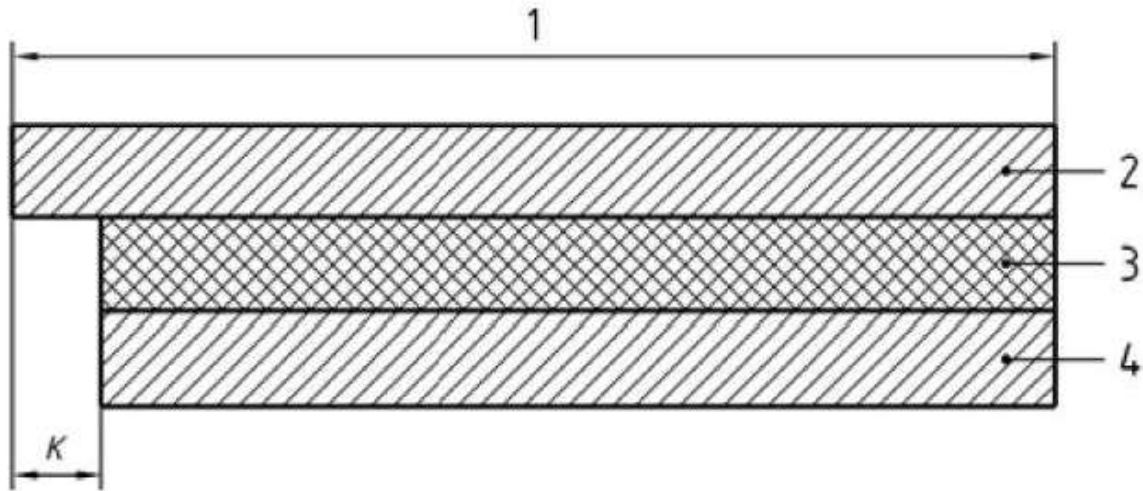

## Key

- 1 - length of profile
- 2 - profile 1
- 3 - thermal barrier
- 4- profile 2

Figure 4 - Length offset  $K$

## 3 , Tolerances on form

### 3,1 - Plane parallelism

Requirements on plane parallelism // of opposite outer planes shall be subject of prior agreement with the client and shall be specified on the drawing,

Plane parallelism shall be marked on the drawing as specified in Figure 5, using the // symbol, Tolerances on plane parallelism shall not increase tolerances on dimensions, i.e, shall always lie within dimensional tolerances or tolerance ranges,

Where outer planes are of unequal length, the longer one shall be taken as contact reference,

Two clearly defined reference points shall specify the width of the plane parallelism measurement,

The tolerance on plane parallelism // shall be in accordance with the tolerance ranges given in Table 1 for outer parallel dimensions  $H$  (including those for open ends) and apply for only cross sectional measurements in a single plane,





Requirements in the figure ( $//, 0,4$ ) is an example only, Tolerances to be according to Table 1:

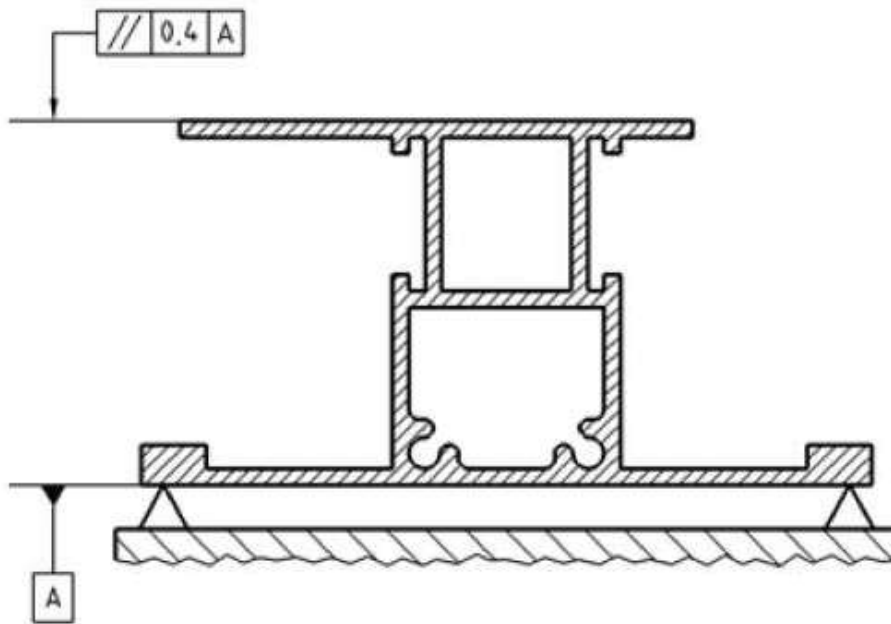

**Figure 5 - Marking plane parallelism for convex and concave surfaces**

### 3,2 Straightness

Deviations from straightness,  $h_s$  and  $h_t$ , shall be measured as shown in Figure 6 with the profile placed on a horizontal base plate so that its mass decreases the deviation,  
 The straightness tolerance  $h_t$  shall be as specified in Table 4,  
 The local deviation from straightness  $h_s$  shall not exceed 0,3 mm per 300 mm length,

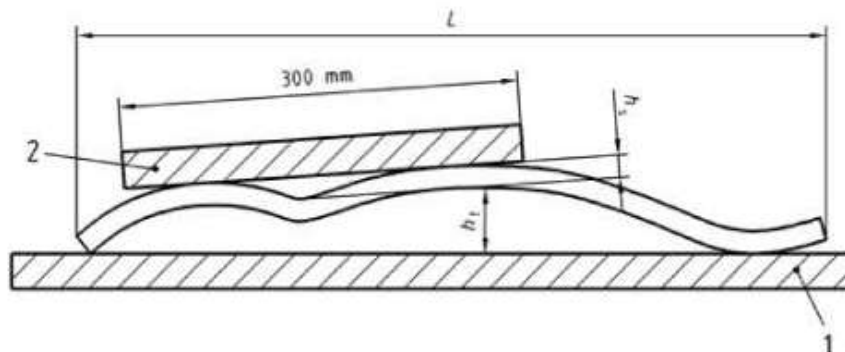

**Key**

- 1 - base plate
- 2 - straight edge

**Figure 6 - Measurement of deviation from straightness**

**Table 4 - Straightness tolerances**

Dimensions in millimetres

Straightness tolerance $ht$ for specified length $L$						
$L \leq 1000$	$L \leq 2000 > 1000$	$L \leq 3000 > 2000$	$L \leq 4000 > 3000$	$L \leq 5000 > 4000$	$L \leq 6000 > 5000$	$L > 6000$
0,7	1,3	1,8	2,2	2,6	3,0	3,5

### 3,3 - Convexity - Concavity

The convexity-concavity  $f$  shall be measured as shown in Figures 7 and 8, The tolerances shall be as specified in Table 5,

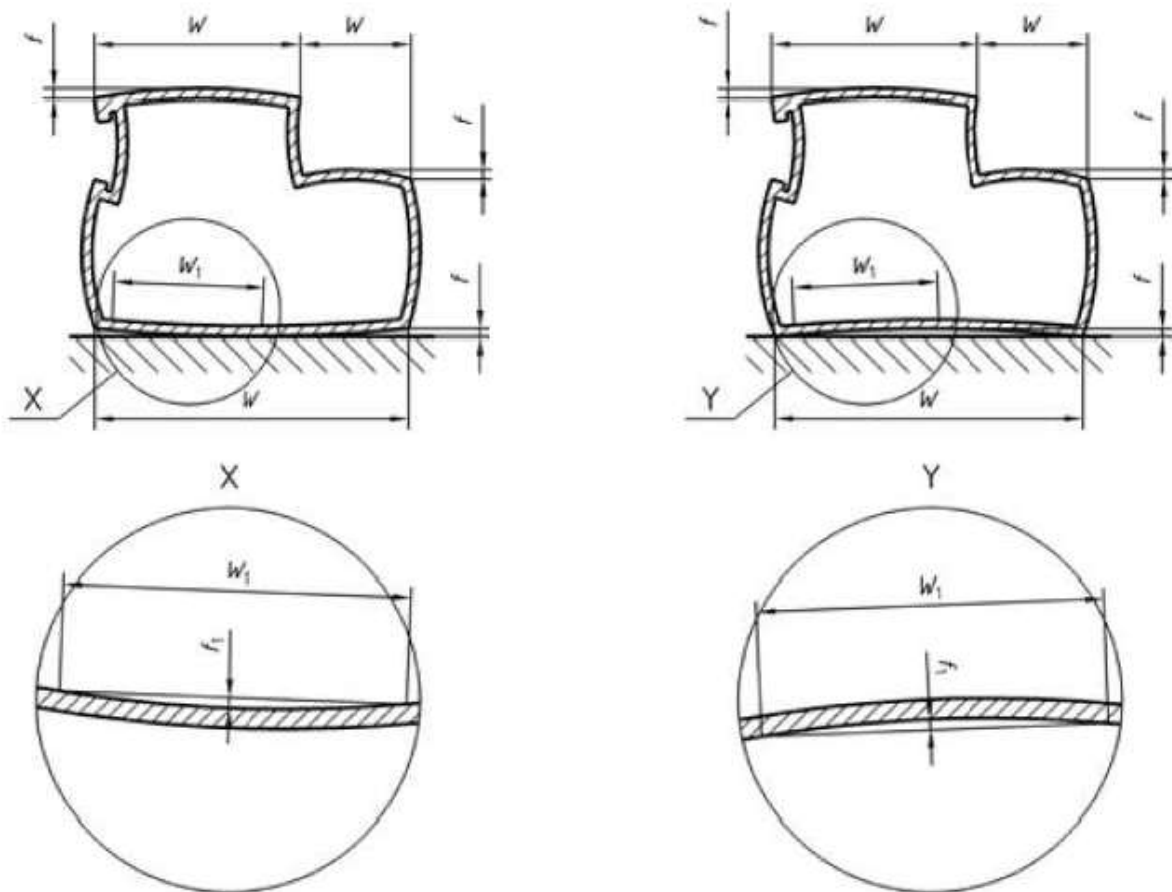

#### Key

$W$  = width       $f$  = deviation       $W_1 = 100$  mm       $f_1$  = local deviation per any 100 mm

**Figure 7 - Measurement of convexity – concavity for hollow section**

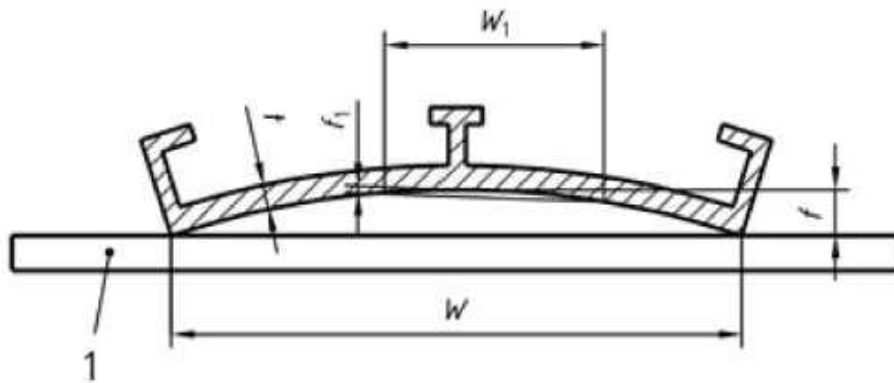

## Key

1 = base plate  $W$  = width  $f$  = deviation  $W_1 = 100$  mm  $f_1$  = local deviation per any 100 mm

**Figure 8 - Measurement of convexity-concavity for open section**

**Table 5 - Convexity-concavity tolerances**

Dimensions in millimetres

Width $W$		Maximum allowable deviation $f$
Over	Up to and including	
-	30	0,20
30	60	0,30
60	100	0,40
100	150	0,50
150	200	0,70
200	250	0,85
250	300	1,0
300	350	1,2

In the case of profiles with a width  $W$  of over 150 mm, the local deviation  $f_1$  shall not exceed 0,50 mm for any width  $W_1$  of 100 mm,

## 3,4 - Contour

For profiles with curved cross sections, the deviation at any point of the curve, from the theoretically exact line as defined by the drawing shall not be greater than the appropriate tolerance  $C$  specified in Table 6,

Considering all points on the curve, a tolerance zone shall be defined as the zone between two envelopes running tangentially to all circles of diameter  $C$  which can be drawn with their centres lying along the theoretically exact line; this is shown in Figure 9,

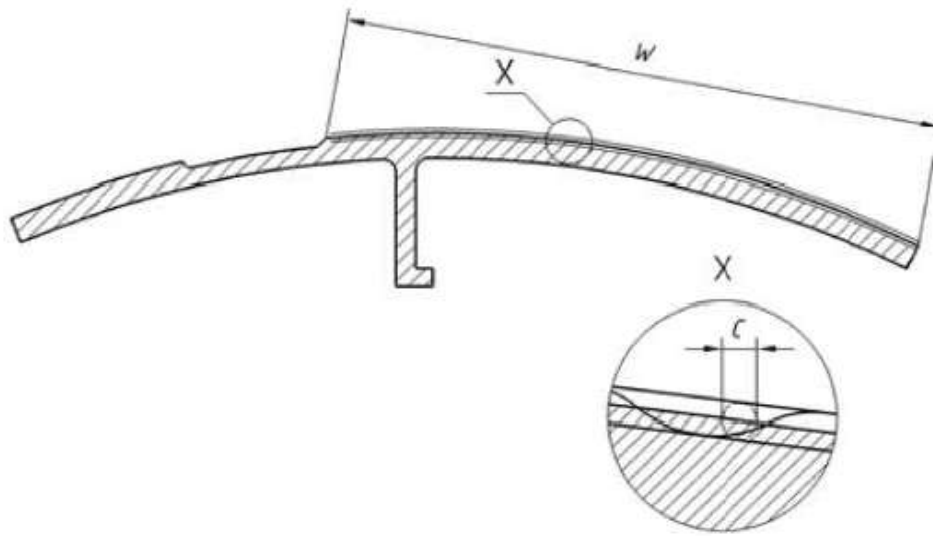

**Figure 9 - Definition of contour tolerances**

**Table 6 - Contour tolerances**

Dimensions in millimetres

Width $W$ of the contour		Contour tolerance = Diameter $C$ of the tolerance circle
Over	Up to and including	
-	30	0,30
30	60	0,50
60	90	0,70
90	120	1,00
120	150	1,20
150	200	1,50
200	250	2,00
250	300	2,50
300	350	3,00

NOTE Contour tolerances can be checked by placing a section of the profile on a scale projection of the drawing with the contour tolerance indicated on the drawing, Another recommended method is the use of suitable gauge (min./max.),

### 3,5 - Twist

Twist  $T$  shall be measured as shown in Figure 10 by placing the profile on a flat base plate, the profile resting under its own mass and measuring the maximum distance at any point along the length between the bottom surface of the profile and the base plate surface, Tolerances shall be specified in Table 7 as a function of the width  $W$  and the length  $L$  of the profile,

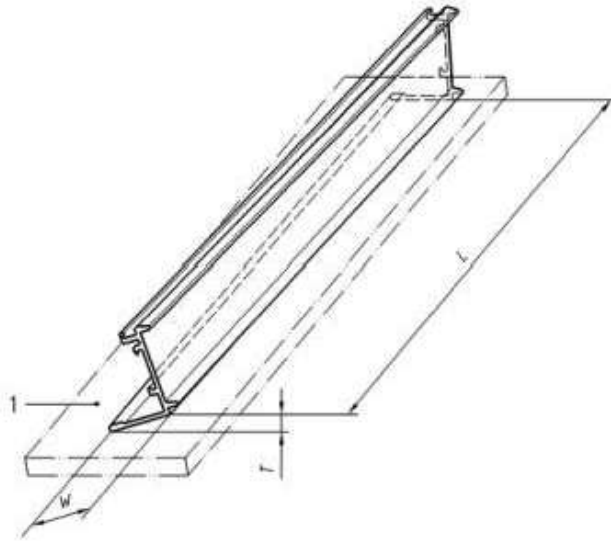

**Key**

1 base plate

**Figure 10 - Measurement of twist**

**Table 7 - Twist tolerances**

Dimensions in millimetres

Width $W$		Twist tolerances $T$ for specified length $L$						
Over	Up to and including	$L \leq 1\ 000$	$L > 000\ 1$ $000\ 2 \geq$	$L > 000\ 2$ $000\ 3 \geq$	$L > 000\ 3$ $000\ 4 \geq$	$L > 000\ 4$ $000\ 5 \geq$	$L > 000\ 5$ $000\ 6 \geq$	$L > 6\ 000$
-	75	1,0	1,2	1,5	1,8	2,0	2,0	Subject to prior agreement with the client
75	100	1,0	1,2	1,5	2,0	2,2	2,5	
100	125	1,0	1,5	1,8	2,2	2,5	3,0	
125	150	1,2	1,5	1,8	2,2	2,5	3,0	
150	200	1,5	1,8	2,2	2,6	3,0	3,5	
200	350	1,8	2,5	3,0	3,5	4,0	4,5	

## 3,6 - Angularity

The deviation from a specified angle shall be measured as shown in Figures 11 and 12,

The angularity tolerances for right angles shall be as specified in Table 8 as a function of profile width  $W$ , The maximum allowable deviation ( $\alpha$ ) for angles other than a right angle shall be  $\pm 1^\circ$  (see Figure 12),

In the case of unequal side lengths the tolerances on angularity shall apply to the shorter side of the angle, i.e, the measurement should start with the longer side,

**Table 8 - Tolerances for right angles**

Dimensions in millimetres

Width W		Maximum allowable deviation Z from a right angle
Over	Up to and including	
-	30	0,30
30	50	0,40
50	80	0,50
80	100	0,60
100	120	0,70
120	140	0,80
140	160	0,90
160	180	1,0
180	200	1,2
200	250	1,5

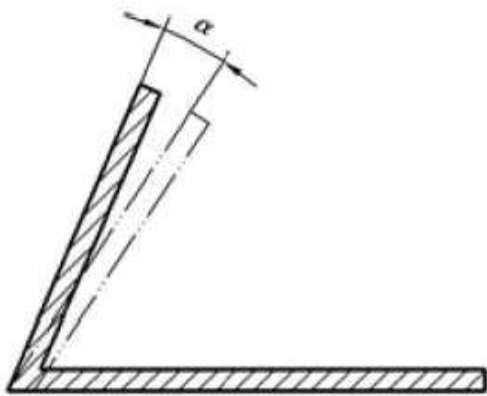

**Figure 11 - Measurement of angularity of a right angle**

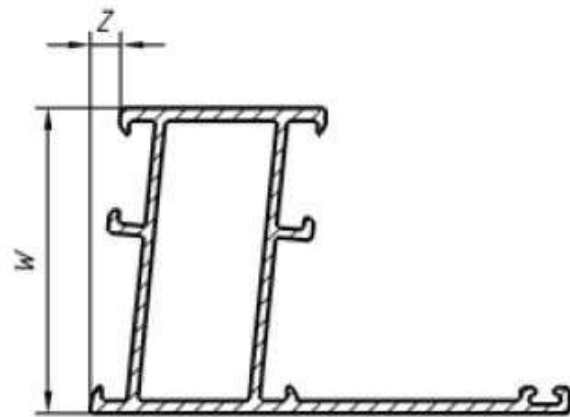

**Figure 12 - Measurement of angularity of other than right angles**



### 3,7 - Corner and fillet radii

Sharp corners and fillets may be slightly rounded, unless otherwise indicated on the drawing, The maximum allowable corner and fillet radii shall be as specified in Table 9, When a corner or fillet radius is specified, the maximum allowable deviation from this specified radius shall be as given in Table 10,

**Table 9 - Maximum allowable corner and fillet radii**

Dimensions in millimetres

Wall thickness A, B <sup>a</sup> or C <sup>a</sup>		Maximum allowable corner and fillet radii
Over	Up to and including	
-	3	0,5
3	6	0,6
6	10	0,8
10	20	1,0
20	40	1,5

a - When varying wall thicknesses are involved, the maximum allowable radius in the transition zone is a function of the greater wall thickness,

**Table 10 - Maximum allowable deviations from specified corner and fillet radii**

Specified radius mm	Maximum allowable deviations from specified radius
≤ 1,0	± 0,30 mm
>1,0 to ≤ 5,0	± 0,50 mm
>5,0	± 10 %

# INDEX



Section Number	Page	Section Number	Page	Section Number	Page
10064	7	10029	65	10001	58
10065	99	10030	118	10002	50
10066	100	10031	118	10003	40
10067	99	10032	33	10004	40
10068	58	10033	51	10005	6
10069	128	10036	122	10006	6
10070	128	10038	133	10007	26
10071	128	10040	89	10008	26
10072	128	10041	89	10009	6
10073	87	10042	118	10010	6
10074	87	10043	17	10011	39
10075	88	10044	51	10012	39
10076	88	10046	68	10013	6
10077	95	10047	26	10014	6
10078	40	10048	26	10015	31
10080	62	10049	120	10016	133
10081	41	10050	119	10017	133
10082	62	10053	75	10018	133
10083	7	10054	128	10020	139
10084	7	10055	75	10022	139
10086	20	10056	95	10023	24
10087	20	10057	95	10024	24
10088	26	10060	68	10025	58
10089	26	10061	41	10026	62
10090	98	10062	41	10027	133
10091	94	10063	7	10028	51



رقم المقطع	الصفحة
10154	114
10155	114
10156	127
10157	112
10159	100
10160	8
10161	8
10162	127
10163	91
10164	76
10165	62
10166	109
10167	74
10168	74
10169	86
10170	96
10171	39
10172	96
10173	66
10174	96
10175	127
10176	51
10177	133
10178	133
10179	133
10180	133

رقم المقطع	الصفحة
10128	8
10129	8
10130	25
10131	25
10132	40
10133	99
10134	88
10135	87
10136	85
10137	85
10138	75
10139	59
10140	79
10141	80
10142	79
10143	108
10144	89
10145	140
10146	80
10147	77
10148	23
10149	119
10150	120
10151	58
10152	63
10153	114

رقم المقطع	الصفحة
10092	94
10093	23
10094	23
10095	94
10096	97
10097	94
10098	96
10099	23
10100	98
10101	75
10102	7
10105	140
10106	98
10107	99
10113	49
10114	88
10115	88
10116	88
10117	119
10119	39
10120	7
10121	24
10122	24
10125	119
10126	119
10127	99

# INDEX



Section Number	Page	Section Number	Page	Section Number	Page
10233	126	10207	70	10181	53
10234	123	10208	70	10182	132
10235	123	10209	72	10183	25
10236	125	10210	39	10184	25
10237	71	10211	58	10185	39
10238	71	10212	78	10186	98
10239	71	10213	78	10187	96
10240	71	10214	76	10188	99
10241	73	10215	58	10189	62
10242	73	10216	62	10190	98
10243	133	10217	9	10191	8
10244	133	10218	9	10192	8
10245	97	10219	72	10193	127
10246	73	10220	72	10194	127
10247	73	10221	72	10195	128
10248	73	10222	72	10196	69
10249	73	10223	71	10197	69
10250	74	10224	71	10198	70
10251	74	10225	125	10199	69
10252	9	10226	126	10200	72
10253	9	10227	125	10201	69
10254	77	10228	76	10202	69
10256	66	10229	76	10203	70
10257	31	10230	76	10204	70
10258	74	10231	76	10205	69
10259	74	10232	126	10206	70

رقم المقطع	الصفحة
10318	11
10319	17
10320	17
10321	43
10322	118
10323	12
10324	34
10325	12
10326	12
10327	43
10328	111
10329	12
10330	12
10331	43
10334	13
10335	13
10336	13
10337	13
10338	43
10342	27
10343	27
10344	42
10345	25
10346	25
10347	42
10348	14

رقم المقطع	الصفحة
10290	35
10291	41
10292	87
10293	87
10294	61
10295	61
10296	23
10297	23
10298	113
10299	101
10300	141
10301	141
10302	141
10303	142
10304	142
10305	145
10306	145
10307	144
10308	144
10309	38
10310	10
10311	10
10312	43
10315	115
10316	86
10317	11

رقم المقطع	الصفحة
10260	41
10261	61
10262	75
10263	9
10264	9
10265	98
10266	126
10267	126
10268	126
10269	82
10270	84
10271	112
10272	24
10273	24
10274	49
10275	103
10276	103
10277	103
10278	103
10282	66
10283	10
10284	10
10285	41
10287	35
10288	35
10289	35



رقم المقطع	الصفحة
20065	89
20066	63
20067	68
20069	40
20070	40
20077	95
20081	95
20085	110
20086	110
20087	53
20088	45
20089	100
20090	110
20091	56
20092	59
20093	51
20094	134
20095	45
20097	56
20098	38
20099	38
20100	135
20101	38
20102	20
20103	21
20104	20

رقم المقطع	الصفحة
20028	68
20029	18
20030	18
20031	18
20032	50
20033	50
20034	56
20035	55
20036	134
20037	134
20038	134
20039	136
20040	34
20041	53
20042	53
20043	52
20044	137
20045	65
20046	38
20047	122
20056	136
20060	122
20061	136
20062	135
20063	89
20064	89

رقم المقطع	الصفحة
20001	134
20002	134
20003	134
20004	134
20005	18
20006	18
20007	18
20008	47
20009	32
20010	32
20011	32
20012	51
20013	34
20014	136
20015	136
20016	47
20017	49
20018	49
20019	47
20021	29
20022	29
20023	29
20024	46
20025	45
20026	45
20027	68

# INDEX

رقم المقطع	الصفحة	رقم المقطع	الصفحة	رقم المقطع	الصفحة
20160	112	20131	45	20105	20
20161	110	20132	65	20106	97
20162	100	20133	101	20107	94
20163	113	20134	101	20108	97
20164	112	20135	101	20109	97
20165	119	20136	101	20110	101
20166	109	20137	56	20111	121
20167	122	20138	65	20112	121
20168	125	20139	78	20113	121
20169	45	20140	79	20114	121
20170	19	20141	108	20115	121
20171	19	20144	108	20116	121
20172	19	20145	43	20117	94
20173	114	20147	47	20118	52
20174	110	20148	138	20119	110
20175	90	20149	80	20120	29
20176	90	20150	60	20121	29
20177	90	20151	60	20122	30
20178	90	20152	137	20123	30
20179	90	20153	109	20124	30
20180	90	20154	109	20125	19
20181	91	20155	108	20126	82
20182	109	20156	114	20127	49
20183	55	20157	108	20128	49
20184	138	20158	112	20129	52
20185	19	20159	112	20130	136

رقم المقطع	الصفحة
20238	115
20239	114
20240	134
20241	137
20242	82
20243	82
20244	77
20245	77
20246	30
20247	30
20248	30
20249	19
20250	29
20251	57
20252	61
20253	60
20254	59
20255	66
20256	115
20257	60
20258	10
20259	10
20260	125
20261	17
20263	57
20264	100

رقم المقطع	الصفحة
20212	100
20213	109
20214	32
20215	108
20216	132
20217	52
20218	78
20219	78
20220	78
20221	56
20222	77
20223	91
20224	91
20225	82
20226	34
20227	82
20228	134
20229	57
20230	125
20231	123
20232	123
20233	123
20234	123
20235	124
20236	124
20237	124

رقم المقطع	الصفحة
20186	20
20187	65
20188	134
20189	138
20190	52
20191	52
20192	53
20193	77
20194	80
20195	55
20196	56
20197	97
20198	65
20199	96
20200	31
20201	64
20202	64
20203	59
20204	95
20205	129
20206	79
20207	80
20208	38
20209	47
20210	32
20211	134

# INDEX

رقم المقطع	الصفحة	رقم المقطع	الصفحة	رقم المقطع	الصفحة
20328	64	20299	144	20265	102
20329	55	20300	144	20266	102
20330	46	20301	143	20267	102
20333	57	20302	143	20268	102
20334	111	20303	143	20269	102
20335	111	20304	145	20270	102
20336	104	20305	33	20271	103
20337	104	20306	57	20272	103
20340	35	20307	91	20273	60
20342	46	20308	75	20274	64
20343	55	20309	117	20275	33
20344	16	20310	117	20276	57
20345	16	20311	117	20285	84
20346	46	20313	34	20286	113
20347	85	20316	138	20287	113
20348	83	20317	115	20288	138
20349	83	20318	115	20289	141
20350	129	20319	115	20290	141
20351	129	20320	116	20291	141
20352	64	20321	116	20292	143
20353	55	20322	116	20293	143
20354	34	20323	116	20294	143
20355	134	20324	116	20295	142
20356	83	20325	116	20296	145
20357	83	20326	84	20297	144
20358	118	20327	59	20298	144









Massouh Aluminium  
Company

TEL : +963.11.3332349  
FAX : +963.11.3319947  
INFO @ MASSOUHGROUP.COM  
WWW.MASSOUHGROUP.COM  
WWW.MASALCOALUMINIUM.COM